



SPECIFICATION GUIDE

2023



**ARTOLITE
SIAP
MENERANGI
NEGERI**

2023



PT. ARTOLITE INDAH MEDIATAMA

Jl. Raya Jakarta Bogor KM 34,5 Gg. Nangka
Cimanggis Depok 19453
Ph : (62-21) 8774 2572/73, 874 0789
Fax : (62-21) 874 1188/89
www.artolite.co.id

JAKARTA

Jl. Salemba Raya, Gedung Kenari Mas Lt.LG A1 / A2
Jakarta Pusat 10340
Ph : 62-21 398 41830 Fax : 62-21 398 45740

Jl. Gajah Mada No.3-5, Komp. Duta Merlin Blok C No.10
Jakarta Pusat 10130
Ph : 62-21 634 1847 Fax : 62-21 634 2155

SUMATERA

Jl. Riau Ujung No.83 A
Pekanbaru 28292
Ph : 62-761 855 132 Fax : 62-761 856 572

JAWA

Jl. H.Agus Salim, Komp. Pertokoan Jurnatan Blok D No.9
Semarang, Jawa Tengah 50137
Ph : 62-24 354 5788 Fax : 62-24 351 5510

Jl. Pasar Besar Wetan No.32/1
Surabaya, Jawa Timur 60147
Ph : 62-31 353 3926, 352 9101 Fax : 62-31 355 2888

BALI

Jl. Imam Bonjol No.555 H
Denpasar Bali 80119
Ph : 62-361 499 331 Fax : 62-361 499 458

KALIMANTAN

Pertokoan Haryono Palace No.27 Jl. MT. Haryono
Balikpapan, Kalimantan Timur 76114
Ph : 62-542 878 641/42 Fax : 62-542 878 643

SULAWESI

Jl. Sulawesi No.233
Makassar,Sulawesi Selatan 90171
Ph : 62-411 362 1051 Fax : 62-411 362 1051

🌐 : www.artolite.co.id

📘 : Artolite Indah Mediatama

📄 : artolitelighting

✉ : sales@artolite.co.id



1976

Artolite adalah pionir produsen rumah lampu lokal yang berdiri sejak tahun 1976. Pengalaman sebagai manufaktur rumah lampu selama 47 tahun membuat kami selalu mengutamakan kepuasan konsumen. Kami didukung tenaga ahli dan berpengalaman sehingga mampu menghasilkan produk armatur lampu yang berkualitas, aman, dan tahan lama. Produk-produk Artolite telah memenuhi sertifikasi Standar Nasional Indonesia (SNI) dan ISO, serta sudah bersertifikat Tingkat Komponen Dalam Negeri (TKDN). Artolite memiliki pabrik manufaktur rumah lampu yang berlokasi di Cimanggis, Depok, Jawa Barat. Pabrik seluas 20.000m² dilengkapi gudang produk sebesar 6.500 m². Kami menerapkan manajemen dan pengolahan air limbah dari semua proses produksi di pabrik yang aman bagi lingkungan.

2023

I. INDOOR LUMINAIRES

8

CEILING

8

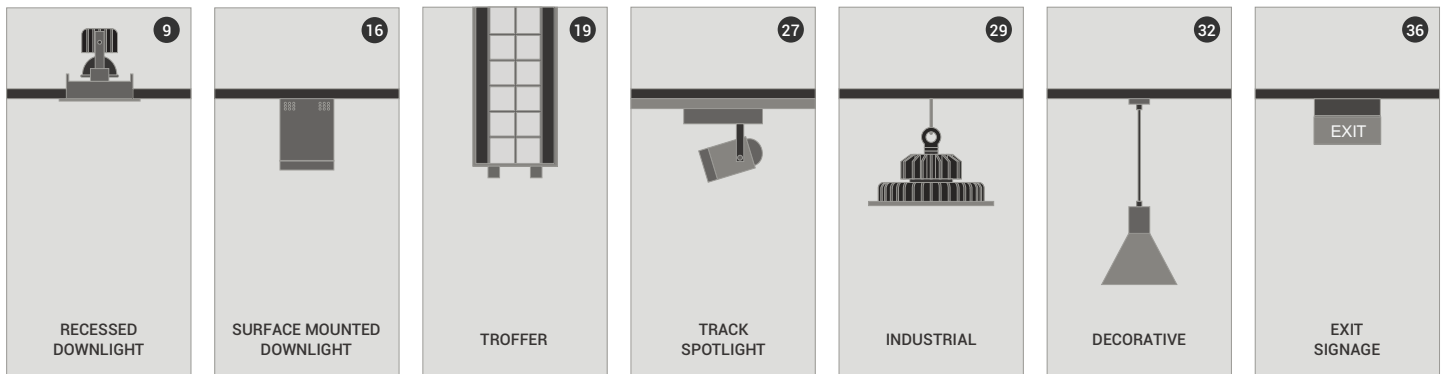

WALL

38

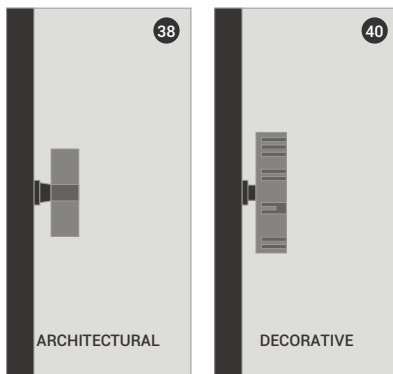

COMPONENT

41

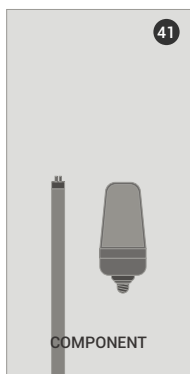

EXIT

II. OUTDOOR LUMINAIRES

43

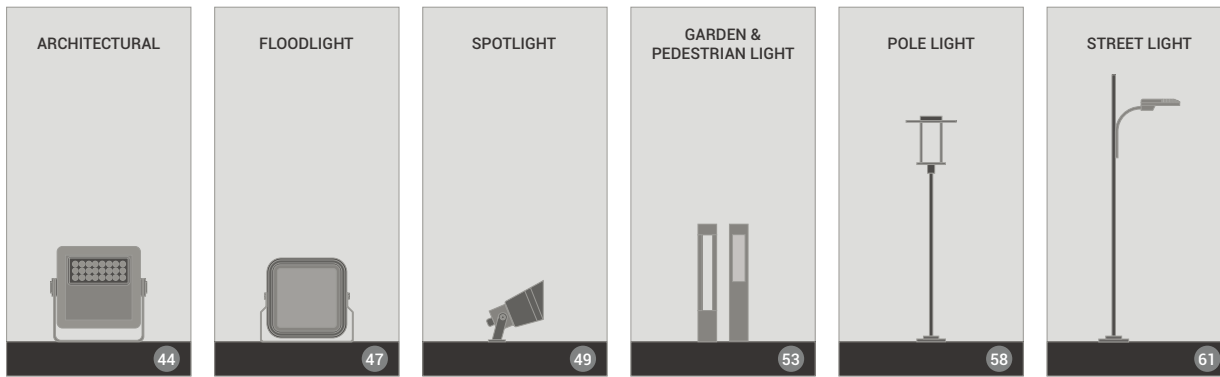

III. LED STRIP

66

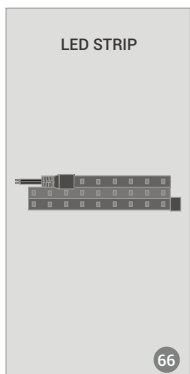

IV. PROJECT REFERENCES

67

EXIT



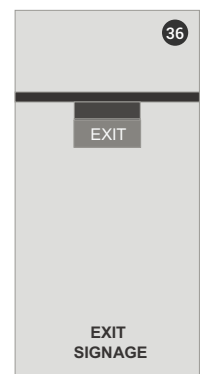
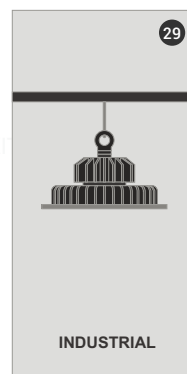
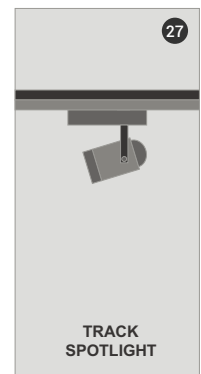
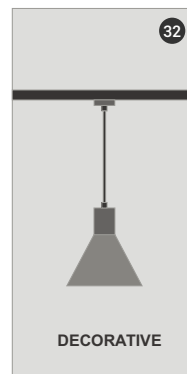
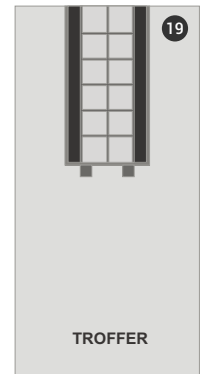
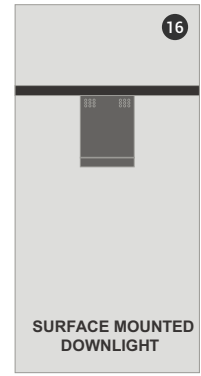

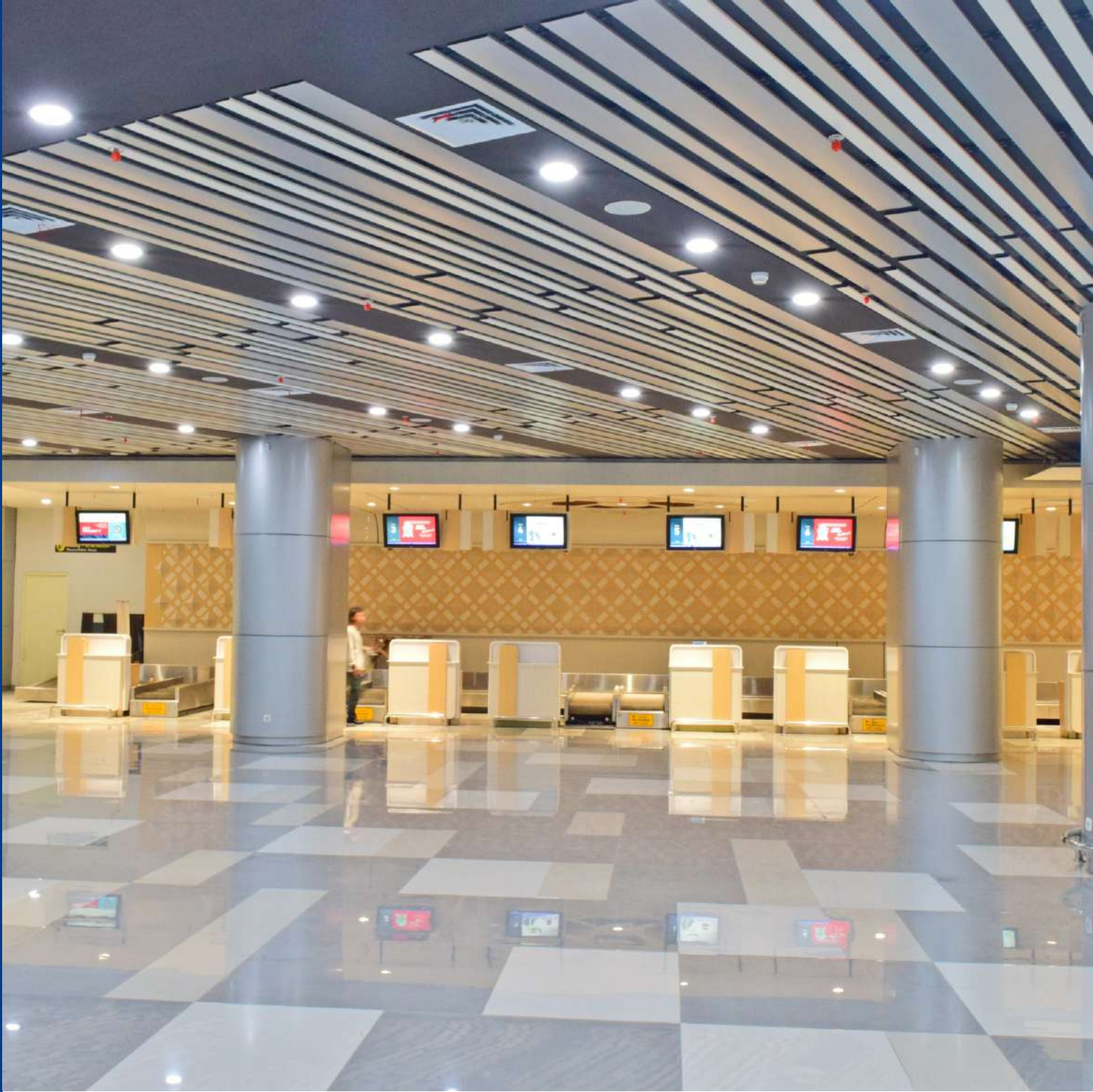

RECESSED DOWNLIGHT

For General Lighting

RD 100 E27

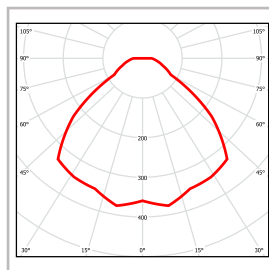
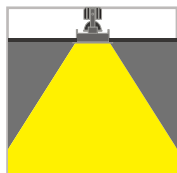
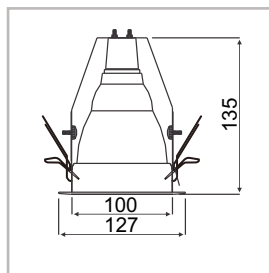

LIGHT SOURCE

LED Source : Led Bulb
 CCT : 3000K-6500K
 Wattage : 4-8 W
 Beam Angle : 120°
 CRI : 80Ra
 Lumen : 420-770lm
 Efficacy : up to 120lm/W
 Dimming Type : Non-Dimmable

HOUSING

Dimension : D 127 mm x T 135 mm
 Cut-Out : 110 mm
 Finishing : White Powder Coating
 Material : Steel Plate
 Orientation : Fixed
 Trim : Trim
 IP Rating : IP20

RD 125 E27

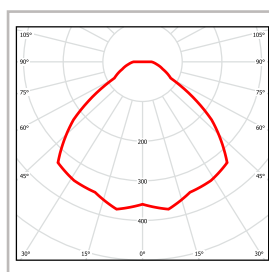
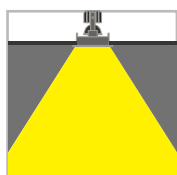
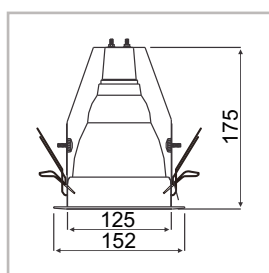

LIGHT SOURCE

LED Source : Led Bulb
 CCT : 3000K-6500K
 Wattage : 4-12 W
 Beam Angle : 120°
 CRI : 80Ra
 Lumen : 420-1210lm
 Efficacy : up to 120lm/W
 Dimming Type : Non-Dimmable

HOUSING

Dimension : D 152 mm x T 175 mm
 Cut-Out : 110 mm
 Finishing : White Powder Coating
 Material : Steel Plate
 Orientation : Fixed
 Trim : Trim
 IP Rating : IP20

RD 150 E27

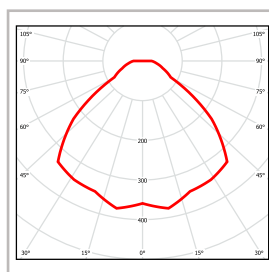
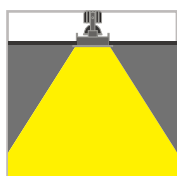
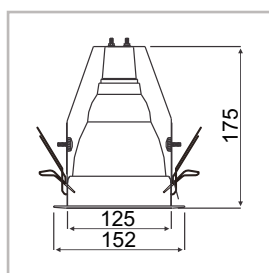

LIGHT SOURCE

LED Source : Led Bulb
 CCT : 3000K-6500K
 Wattage : 4-14.5 W
 Beam Angle : 120°
 CRI : 80Ra
 Lumen : 420-1800lm
 Efficacy : up to 120lm/W
 Dimming Type : Non-Dimmable

HOUSING

Dimension : D 175 mm x T 175 mm
 Cut-Out : 130 mm
 Finishing : White Powder Coating
 Material : Steel Plate
 Orientation : Fixed
 Trim : Trim
 IP Rating : IP20

COZY VHA RD

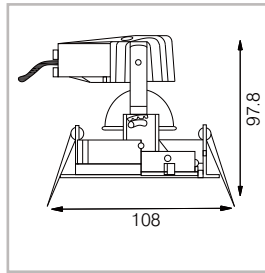

LIGHT SOURCE

LED Source	: MR 16
CCT	: 2700K-6500K
Wattage	: 4-9 W
Beam Angle	: 15-36°
CRI	: 90Ra
Lumen	: 420-1210lm
Efficacy	: 110lm/W
Dimming Type	: Dimmable/ Non Dimmable

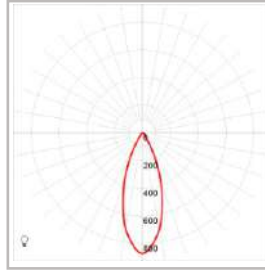
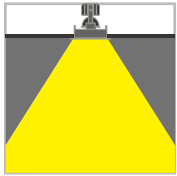

HOUSING

Dimension	: D 108 mm x T 97.8 mm
Cut-Out	: 95 mm
Finishing	: White Powder Coating
Material	: Die-Cast
Orientation	: Adjustable
Trim	: Trim
IP Rating	: IP20

THEME 150 STD

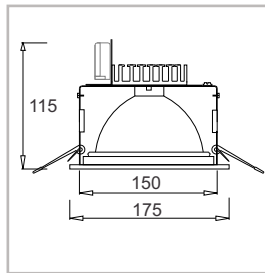

LIGHT SOURCE

LED Source	: LED Core Mini
CCT	: 2700K-6500K
Wattage	: 12-29 W
Beam Angle	: 15-60°
CRI	: 80-90Ra
Lumen	: 1472-4337lm
Efficacy	: up to 160lm/W
Dimming Type	: Dimmable

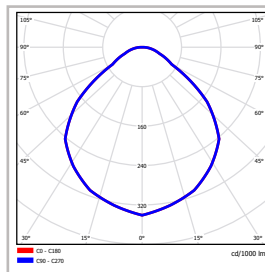
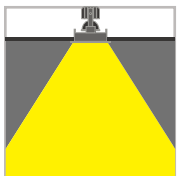

HOUSING

Dimension	: D 175 mm x T 115 mm
Cut-Out	: 150 mm
Finishing	: White Powder Coating
Material	: Steel Plate + Hit Zink
Orientation	: Fixed
Trim	: Trim
IP Rating	: IP20

THEME 175 STD

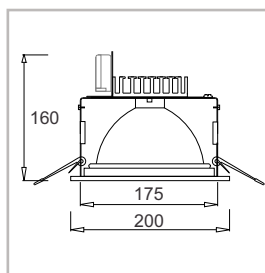

LIGHT SOURCE

LED Source	: LED Core Mini
CCT	: 2700K-6500K
Wattage	: 12-29 W
Beam Angle	: 15-60°
CRI	: 80-90Ra
Lumen	: 1472-4337lm
Efficacy	: up to 160lm/W
Dimming Type	: Dimmable

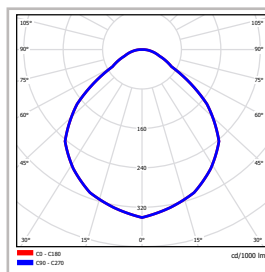
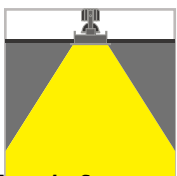

HOUSING

Dimension	: D 200 mm x T 160 mm
Cut-Out	: 170 mm
Finishing	: White Powder Coating
Material	: Steel plate
Orientation	: Fixed
Trim	: Trim
IP Rating	: IP20

RWL 100

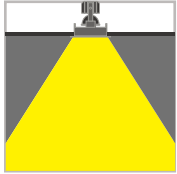
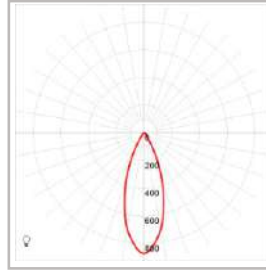
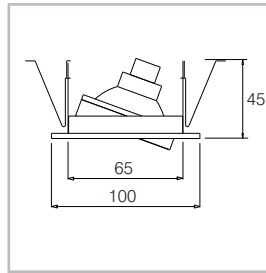

LIGHT SOURCE

LED Source : MR 16 / COB 50
 CCT : 2700K-6500K
 Wattage : 4-12 W
 Beam Angle : 15-40°
 CRI : 90Ra
 Lumen : 400-1500lm
 Efficacy : up to 125lm/W
 Dimming Type : Dimmable/ Non Dimmable

HOUSING

Dimension : D 100 mm x T 45 mm
 Cut-Out : 75 mm
 Body : Die-Cast
 Orientation : Adjustable
 Trim : Trim
 IP Rating : IP20

DO ART 95

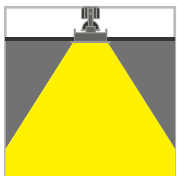
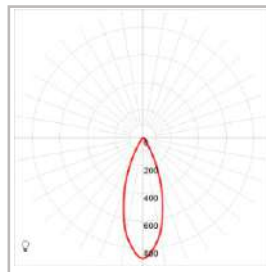
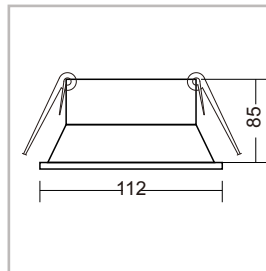

LIGHT SOURCE

LED Source : MR 16 / COB 50
 CCT : 2700K-6500K
 Wattage : 4-12 W
 Beam Angle : 15-40°
 CRI : 90Ra
 Lumen : 400-1500lm
 Efficacy : up to 125lm/W
 Dimming Type : Dimmable/ Non Dimmable

HOUSING

Dimension : D 112 mm x T 85 mm
 Cut-Out : 105 mm
 Finishing : White Powder Coating
 Material : Die-Cast
 Orientation : Adjustable
 Trim : Trim
 IP Rating : IP20

RD 175 CN

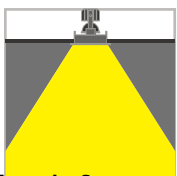
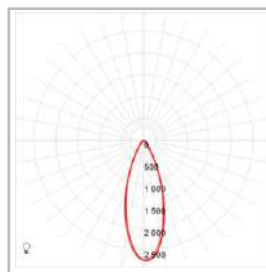
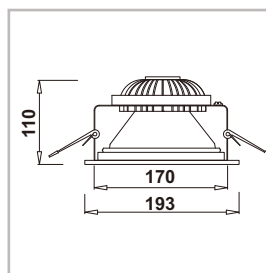

LIGHT SOURCE

LED Source : COB 111
 CCT : 2700K-6500K
 Wattage : 25-37 W
 Beam Angle : 15-60°
 CRI : 90Ra
 Lumen : 2686-4356lm
 Efficacy : up to 110lm/W
 Dimming Type : Dimmable/ Non Dimmable

HOUSING

Dimension : D 193 mm x T 110 mm
 Cut-Out : 185 mm
 Finishing : White Powder Coating
 Material : Die-cast
 Orientation : Fixed
 Trim : Trim
 IP Rating : IP20

COMFORT 125 CN

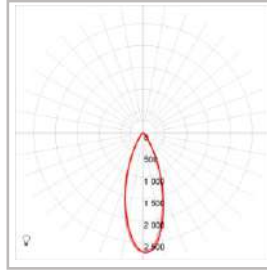
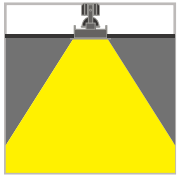
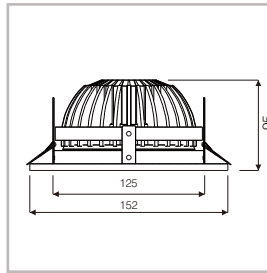
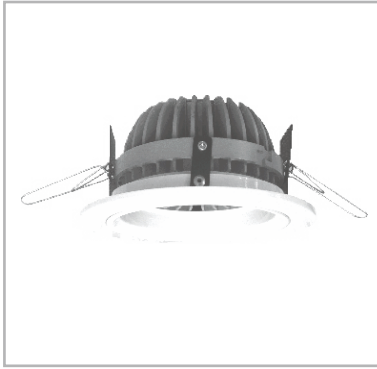

LIGHT SOURCE

LED Source	: COB 111
CCT	: 2700K-6500K
Wattage	: 25-37 W
Beam Angle	: 15-60°
CRI	: 90Ra
Lumen	: 2686-4356lm
Efficacy	: up to 110lm/W
Dimming Type	: Dimmable/ Non Dimmable

HOUSING

Dimension	: D 152 mm x T 95 mm
Cut-Out	: 135 mm
Finishing	: White Powder Coating
Material	: Steel Plate
Orientation	: Fixed
Trim	: Trim
IP Rating	: IP20

COMFORT 150 CN

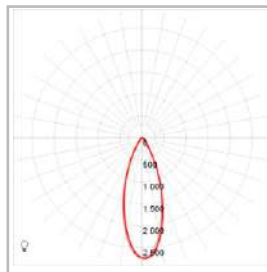
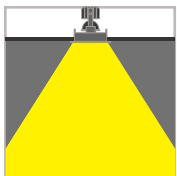
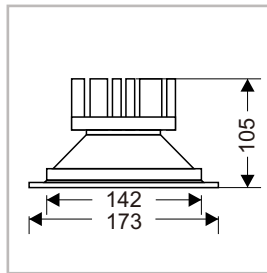

LIGHT SOURCE

LED Source	: COB 111
CCT	: 2700K-6500K
Wattage	: 25-37 W
Beam Angle	: 15-60°
CRI	: 90Ra
Lumen	: 2686-4356lm
Efficacy	: up to 110lm/W
Dimming Type	: Dimmable/ Non Dimmable

HOUSING

Dimension	: D 173 mm x T 105 mm
Cut-Out	: 156 mm
Finishing	: White Powder Coating
Material	: Steel Plate
Orientation	: Fixed
Trim	: Trim
IP Rating	: IP20

COMFORT VHC RD

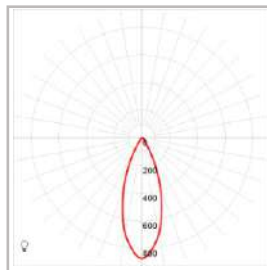
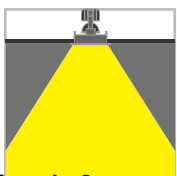
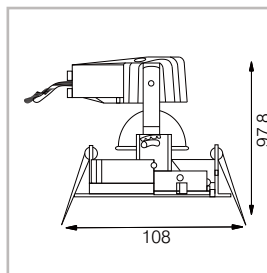

LIGHT SOURCE

LED Source	: MR 16
CCT	: 2700K-6500K
Wattage	: 4-12 W
Beam Angle	: 15-36°
CRI Ra R9	: 90Ra
Lumen	: 420-1210lm
Efficacy	: up to 125lm/W
Dimming Type	: Dimmable/ Non Dimmable

HOUSING

Dimension	: D 108 mm x T 97.8 mm
Cut-Out	: 95 mm
Finishing	: White Powder Coating
Material	: Die-cast
Orientation	: Adjustable
Trim	: Trim
IP Rating	: IP43

FREZA ART

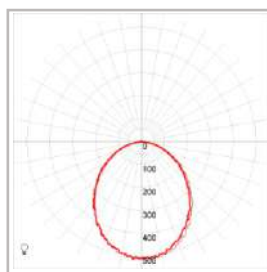
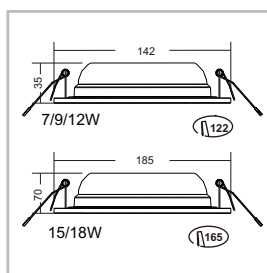
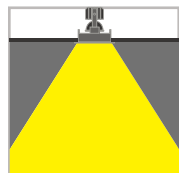

LIGHT SOURCE

LED Source	: Led Star
CCT	: 4000K-6500K
Wattage	: 7-18 W
Beam Angle	: 120 °
CRI	: 95Ra
Lumen	: 700-1800lm
Efficacy	: 100lm/W
Dimming Type	: Non Dimmable

HOUSING

Dimension	: D 142 & 185 mm x T 35 & 70 mm
Cut-Out	: 122 & 165 mm
Body	: ABS
Cover	: ACR
Orientation	: Fixed
Trim	: Trim
IP Rating	: IP20

COMFORT F 200

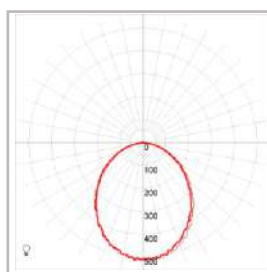
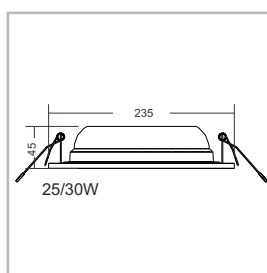
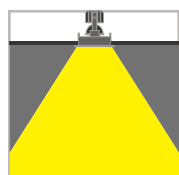

LIGHT SOURCE

LED Source	: Led Star
CCT	: 4000K-6500K
Wattage	: 25-30 W
Beam Angle	: 120 °
CRI	: 95Ra
Lumen	: 2500-3000lm
Efficacy	: 100lm/W
Dimming Type	: Non Dimmable

HOUSING

Dimension	: D 235 mm x T 45 mm
Cut-Out	: 165 mm
Finishing	: White Powder Coating
Material	: Steel Plate
Orientation	: Fixed
Trim	: Trim
IP Rating	: IP20

COZY VH RD

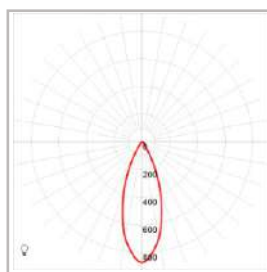
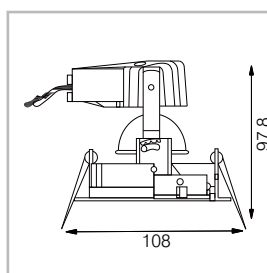
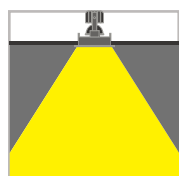

LIGHT SOURCE

LED Source	: MR 16
CCT	: 2700K-6500K
Wattage	: 4-12 W
Beam Angle	: 15-36°
CRI Ra R9	: 90Ra
Lumen	: 420-1210lm
Efficacy	: up to 125lm/W
Dimming Type	: Dimmable/ Non Dimmable

HOUSING

Dimension	: D 108 mm x T 97.8 mm
Cut-Out	: 95 mm
Finishing	: White Powder Coating
Material	: Die-cast
Orientation	: Adjustable
Trim	: Trim
IP Rating	: IP20

SPOTLIGHT MQ

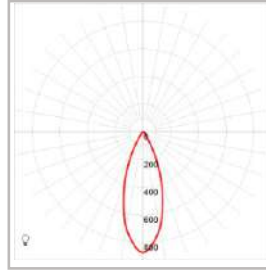
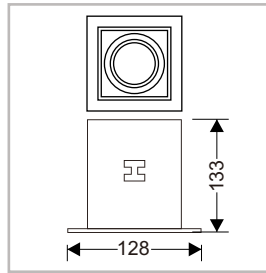
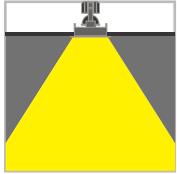

LIGHT SOURCE

LED Source : MR 16, COB 50
 CCT : 2700K-6500K
 Wattage : 4-12 W
 Beam Angle : 15-36°
 CRI : 90Ra
 Lumen : 420-1210lm
 Efficacy : up to 125lm/W
 Dimming Type : Dimmable/ Non Dimmable

HOUSING

Dimension : Available Series 1,2,3 Lamp
 Finishing : White Powder Coating
 Material : Coated Steel Plate
 Orientation : Adjustable
 Trim : Trim
 IP Rating : IP20

COZY SERIES

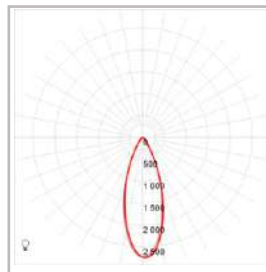
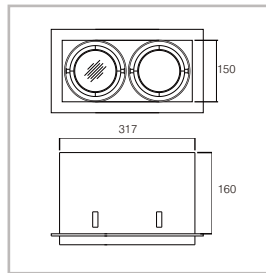
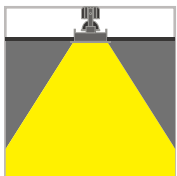

LIGHT SOURCE

LED Source : COB 111
 CCT : 2700K-6500K
 Wattage : 25-37 W
 Beam Angle : 15-60°
 CRI : 90Ra
 Lumen : 2686-4356lm
 Efficacy : up to 110lm/W
 Dimming Type : Dimmable/ Non Dimmable

HOUSING

Dimension : Available Series 1,2,3 Lamp
 Finishing : White Powder Coating
 Material : Steel Plate + Zink
 Orientation : Adjustable
 Trim : Trim
 IP Rating : IP 20

SMD FRZ

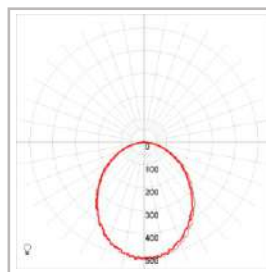
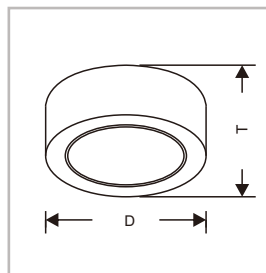
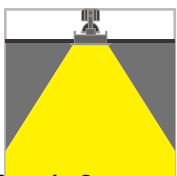

LIGHT SOURCE

LED Source : Leds Star
 CCT : 4000K-6000K
 Wattage : 7-18 W
 Beam Angle : 120°
 CRI : 95Ra
 Lumen : 700-1800lm
 Efficacy : 100lm/W
 Dimming Type : Non Dimmable

HOUSING

Dimension : D 145/190 x T 65
 Body : Steel Plate
 Orientation : Non Adjustable
 Trim : Trim
 IP Rating : IP 20



SURFACED MOUNTED DOWNLIGHT For General Lighting

SMD 150

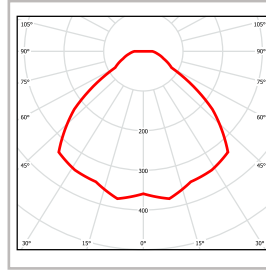
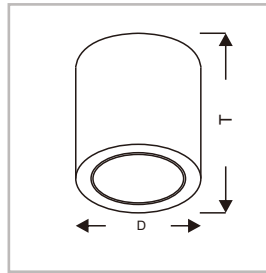
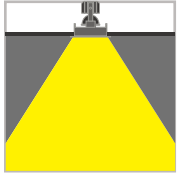

LIGHT SOURCE

LED Source : Led Bulb
 CCT : 3000K-6500K
 Wattage : 4-14.5 W
 Beam Angle : 120 °
 CRI : 90Ra
 Lumen : 400-1800lm
 Efficacy : up to 120lm/W
 Dimming Type : Non Dimmable

HOUSING

Dimension : D 178 x T 195
 Body : Steel Plate
 Orientation : Fixed
 Trim : Trim
 IP Rating : IP 20

SMD 150 CHOTAC

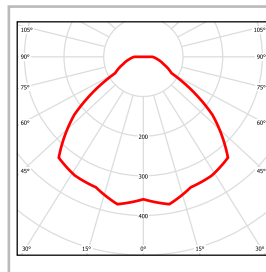
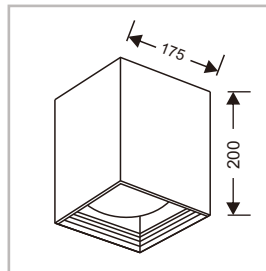
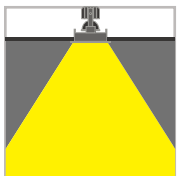

LIGHT SOURCE

LED Source : Led Bulb
 CCT : 3000K-6500K
 Wattage : 4-14.5 W
 Beam Angle : 120 °
 CRI : 90Ra
 Lumen : 400-1800lm
 Efficacy : up to 120lm/W
 Dimming Type : Non Dimmable

HOUSING

Dimension : D 178 x T 195
 Body : Steel Plate
 Orientation : Fixed
 Trim : Trim
 IP Rating : IP 20

ROSET

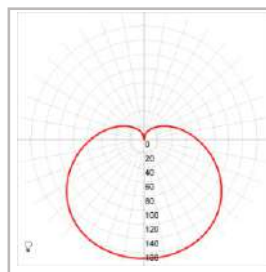
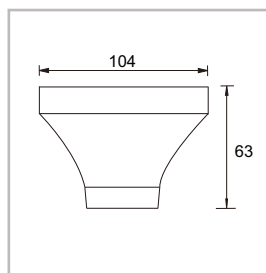
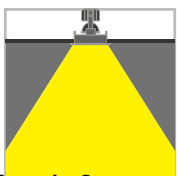

LIGHT SOURCE

LED Source : Led Bulb
 CCT : 3000K-6500K
 Wattage : 4-19 W
 Beam Angle : 120 °
 CRI : 90Ra
 Lumen : 420-2300lm
 Efficacy : up to 120lm/W
 Dimming Type : Non Dimmable

HOUSING

Dimension : D 104 x T 63
 Body : Plastic
 Orientation : Fixed
 IP Rating : IP 20

PLUTOS

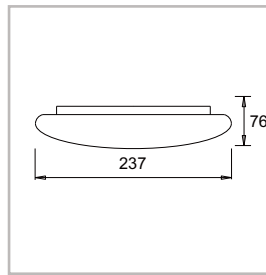

LIGHT SOURCE

LED Source : Leds Star
 CCT : 4000K-6000K
 Wattage : 7-18 W
 Beam Angle : 120 °
 CRI : 95Ra
 Lumen : 700-1800lm
 Efficacy : 100lm/W
 Dimming Type : Non Dimmable

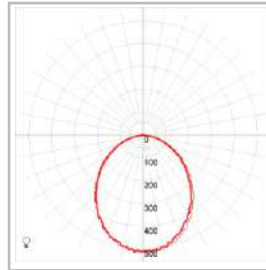
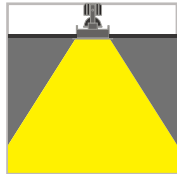

HOUSING

Dimension : 237 mm x 76 mm
 Finishing : White Powder Coating
 Material : ACR
 Orientation : Fixed
 IP Rating : IP20

SCB

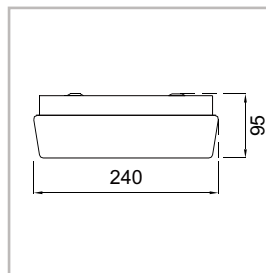

LIGHT SOURCE

LED Source : Leds Star
 CCT : 4000K-6000K
 Wattage : 7-18 W
 Beam Angle : 120 °
 CRI : 95Ra
 Lumen : 700-1800lm
 Efficacy : 100lm/W
 Dimming Type : Non Dimmable

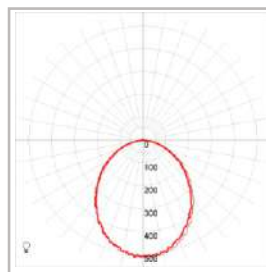
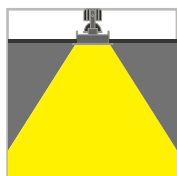

HOUSING

Dimension : 240 mm x 95 mm
 Finishing : White Powder Coating
 Material : ACR
 Orientation : Fixed
 IP Rating : IP20

LUNAR

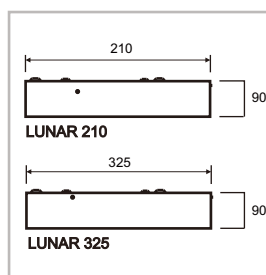

LIGHT SOURCE

LED Source : Leds Star
 CCT : 4000K-6000K
 Wattage : 7-18 W
 Beam Angle : 120 °
 CRI : 95Ra
 Lumen : 700-1800lm
 Efficacy : 100lm/W
 Dimming Type : Non Dimmable

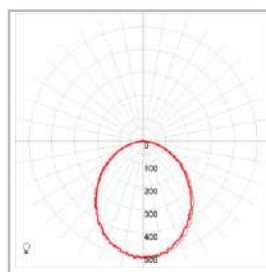
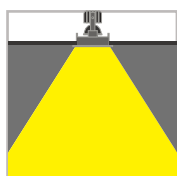

HOUSING

Dimension : D 210/325 x T 90
 Body : Steel Plate
 Orientation : Fixed
 Trim : Trim
 IP Rating : IP 20



TROFFER

For General Lighting

RM SERIES

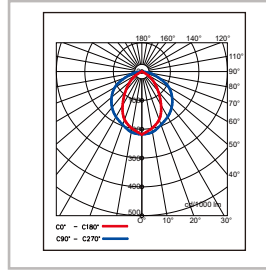
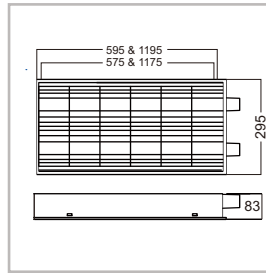
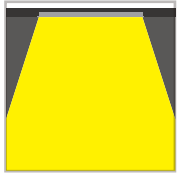
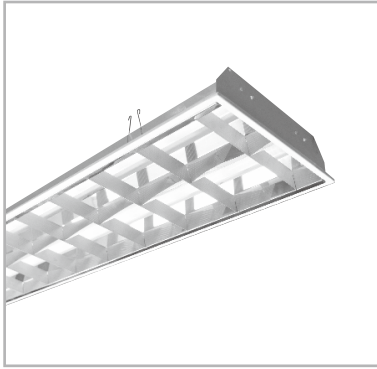

LIGHT SOURCE

LED Source : TL-LED
 CCT : 4000K-6500K
 Wattage : 8-18 W
 Beam Angle : 160°
 CRI : 80Ra
 Lumen : 1050-2100lm
 Efficacy : 130lm/W
 Dimming Type : Non Dimmable

HOUSING

Dimension : 1 x 595 & 1195mm
 2 x 595 & 1195mm
 3 x 595 & 1195mm
 4 x 595 & 1195mm
 Body : Steel Plate
 Louvre : Alanod
 Trim : Trim
 IP Rating : IP 20

RM SERIES DUMMY

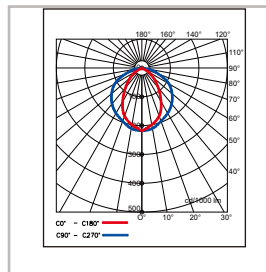
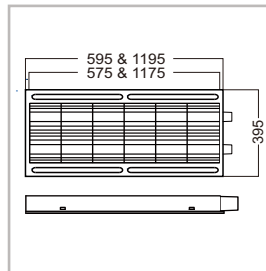
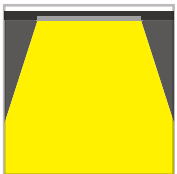

LIGHT SOURCE

LED Source : TL-LED
 CCT : 4000K-6500K
 Wattage : 8-18 W
 Beam Angle : 160°
 CRI : 80Ra
 Lumen : 1050-2100lm
 Efficacy : 130lm/W
 Dimming Type : Non Dimmable

HOUSING

Dimension : 1 x 595 & 1195mm
 2 x 595 & 1195mm
 3 x 595 & 1195mm
 4 x 595 & 1195mm
 Body : Steel Plate
 Louvre : Alanod
 Trim : Trim
 IP Rating : IP 20

RM SERIES RETURN

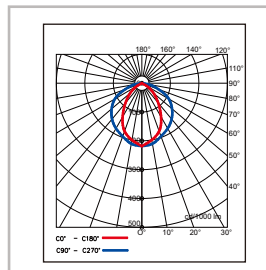
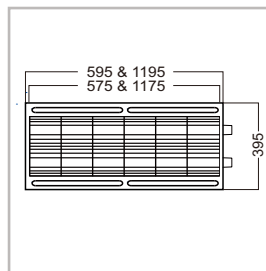

LIGHT SOURCE

LED Source : TL-LED
 CCT : 4000K-6500K
 Wattage : 8-18 W
 Beam Angle : 160°
 CRI : 80Ra
 Lumen : 1050-2100lm
 Efficacy : 130lm/W
 Dimming Type : Non Dimmable

HOUSING

Dimension : 1 x 595 & 1195mm
 2 x 595 & 1195mm
 3 x 595 & 1195mm
 4 x 595 & 1195mm
 Body : Steel Plate
 Louvre : Alanod
 Trim : Trim
 IP Rating : IP 20

RM SERIES DIFFUSER AC

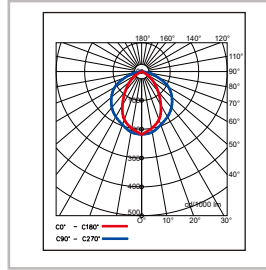
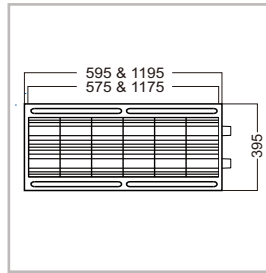
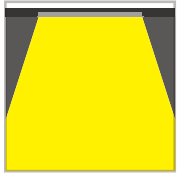

LIGHT SOURCE

LED Source : TL-LED
 CCT : 4000K-6500K
 Wattage : 8-18 W
 Beam Angle : 160°
 CRI : 80Ra
 Lumen : 1050-2100lm
 Efficacy : 130lm/W
 Dimming Type : Non Dimmable

HOUSING

Dimension : 1 x 595 & 1195mm
 2 x 595 & 1195mm
 3 x 595 & 1195mm
 4 x 595 & 1195mm
 Body : Steel Plate
 Louvre : Alanod
 Trim : Trim
 IP Rating : IP 20

RMO

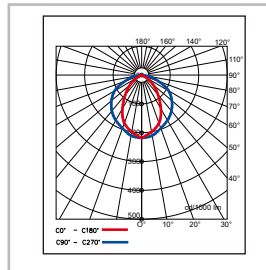
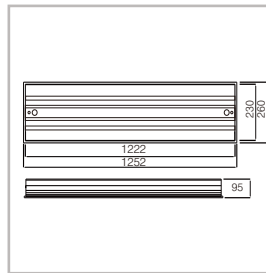
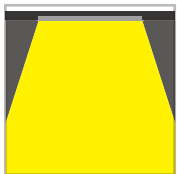

LIGHT SOURCE

LED Source : TL-LED
 CCT : 4000K-6500K
 Wattage : 8-18 W
 Beam Angle : 160°
 CRI : 80Ra
 Lumen : 1050-2100lm
 Efficacy : 130lm/W
 Dimming Type : Non Dimmable

HOUSING

Dimension : 1 x 615 & 1222mm
 2 x 615 & 1222mm
 3 x 615 & 1222mm
 4 x 615 & 1222mm
 Body : Steel Plate
 Louvre : Alanod
 Trim : Trim
 IP Rating : IP 20

RMOT

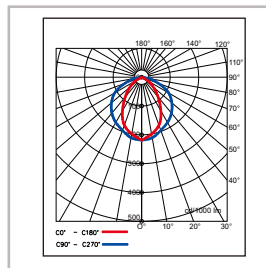
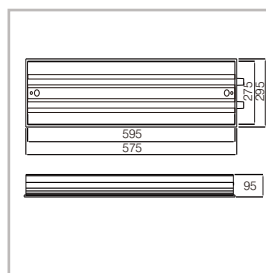
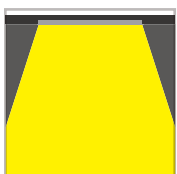

LIGHT SOURCE

LED Source : TL-LED
 CCT : 4000K-6500K
 Wattage : 8-18 W
 Beam Angle : 160°
 CRI : 80Ra
 Lumen : 1050-2100lm
 Efficacy : 130lm/W
 Dimming Type : Non Dimmable

HOUSING

Dimension : 1 x 595 & 1195mm
 2 x 595 & 1195mm
 3 x 595 & 1195mm
 4 x 595 & 1195mm
 Body : Steel Plate
 Louvre : Alanod
 Trim : Trim
 IP Rating : IP 20

RM ACR

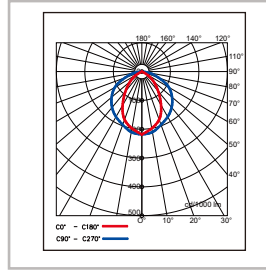
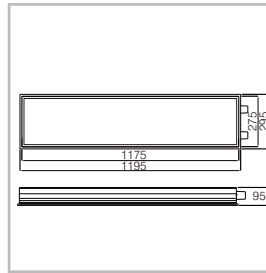
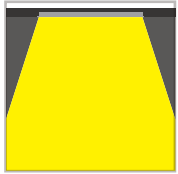
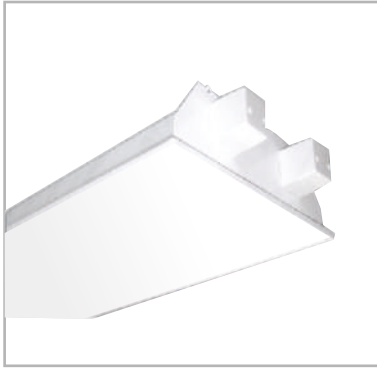

LIGHT SOURCE

LED Source : TL-LED
 CCT : 4000K-6500K
 Wattage : 8-18 W
 Beam Angle : 160°
 CRI : 80Ra
 Lumen : 1050-2100lm
 Efficacy : 130lm/W
 Dimming Type : Non Dimmable

HOUSING

Dimension : 1 x 595 & 1195mm
 2 x 595 & 1195mm
 3 x 595 & 1195mm
 4 x 595 & 1195mm
 Body : Steel Plate
 Cover : ACR
 Trim : Trim
 IP Rating : IP 20

RMO CPOB ASETA BUKA ATAS

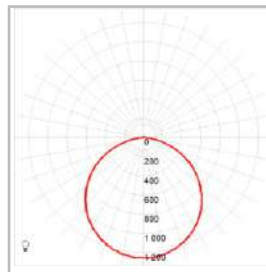
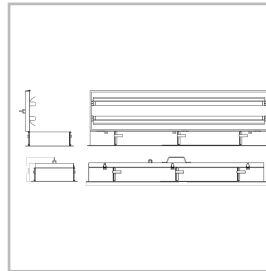
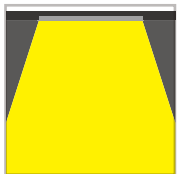

LIGHT SOURCE

LED Source : TL-LED
 CCT : 4000K-6500K
 Wattage : 8-18 W
 Beam Angle : 160°
 CRI : 80Ra
 Lumen : 1050-2100lm
 Efficacy : 130lm/W
 Dimming Type : Non Dimmable

HOUSING

Dimension : 1 x 635 & 1240mm
 2 x 635 & 1240mm
 Body : Steel Plate
 Cover : Tempered Glass
 Trim : Trim
 IP Rating : IP 65

RMO CPOB MINOFEN BUKA BAWAH

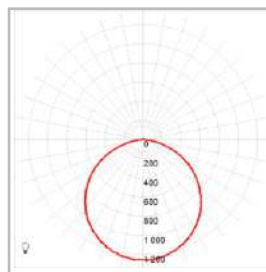
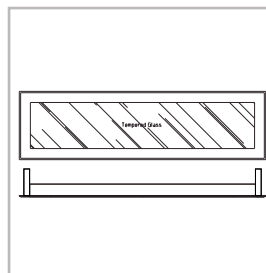

LIGHT SOURCE

LED Source : TL-LED
 CCT : 4000K-6500K
 Wattage : 8-18 W
 Beam Angle : 160°
 CRI : 80Ra
 Lumen : 1050-2100lm
 Efficacy : 130lm/W
 Dimming Type : Non Dimmable

HOUSING

Dimension : 1 x 635 & 1240mm
 2 x 635 & 1240mm
 Body : Steel Plate
 Cover : Tempered Glass
 Trim : Trim
 IP Rating : IP 65

WL TRAPESIUM

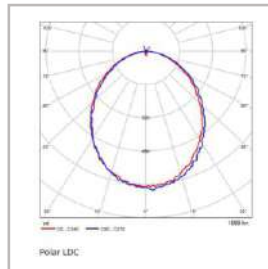
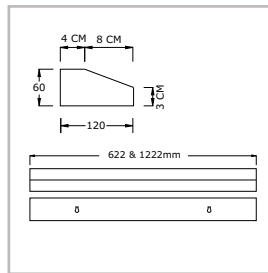
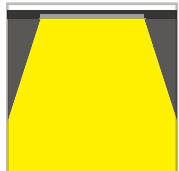

LIGHT SOURCE

LED Source : TL-LED
 CCT : 4000K-6500K
 Wattage : 8-18 W
 Beam Angle : 160°
 CRI : 80Ra
 Lumen : 1050-2100lm
 Efficacy : 130lm/W
 Dimming Type : Non Dimmable

HOUSING

Dimension : 622 & 1222mm
 Body : Steel Plate
 Cover : ACR
 Orientation : Fixed
 IP Rating : IP 20

PASSAT NEO

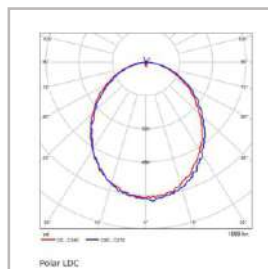
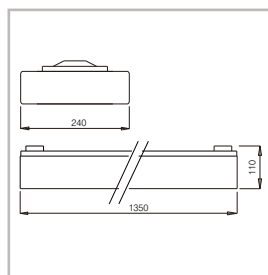
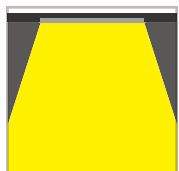

LIGHT SOURCE

LED Source : TL-LED
 CCT : 4000K-6500K
 Wattage : 8-18 W
 Beam Angle : 160°
 CRI : 80Ra
 Lumen : 1050-2100lm
 Efficacy : 130lm/W
 Dimming Type : Non Dimmable

HOUSING

Dimension : 2 x 1350mm
 Body : Steel Plate
 Louvre : Alanod
 Orientation : Fixed
 IP Rating : IP 20

SM M2 SAVVY

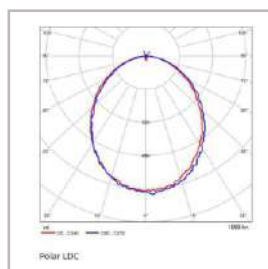
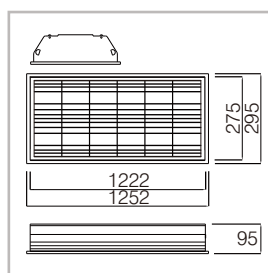
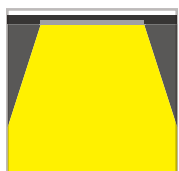

LIGHT SOURCE

LED Source : TL-LED
 CCT : 4000K-6500K
 Wattage : 8-18 W
 Beam Angle : 160°
 CRI : 80Ra
 Lumen : 1050-2100lm
 Efficacy : 130lm/W
 Dimming Type : Non Dimmable

HOUSING

Dimension : 2 x 1222mm
 Body : Steel Plate
 Louvre : Alanod
 Orientation : Fixed
 IP Rating : IP 20

RM LED PANEL

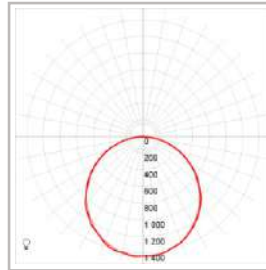
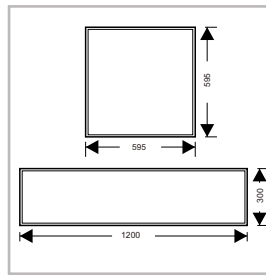
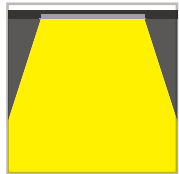
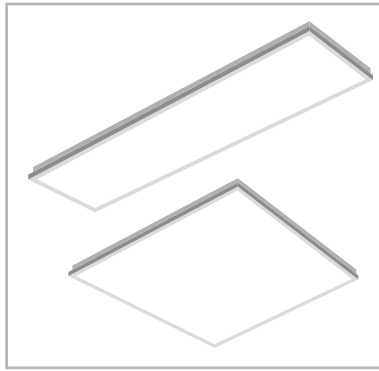

LIGHT SOURCE

LED Source : LED
 CCT : 4000K-6500K
 Wattage : 40 & 60 W
 Beam Angle : 120°
 CRI : 80Ra
 Lumen : 4000-6000lm
 Efficacy : 100lm/W
 Dimming Type : Dimmable/ Non Dimmable

HOUSING

Dimension : 600x600, 1200x300mm
 Body : Steel Plate
 Cover : ACR
 Orientation : Fixed
 IP Rating : IP 20

ARTO LED PANEL

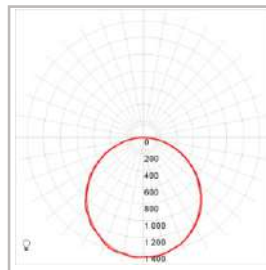
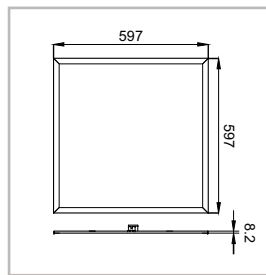
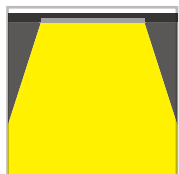
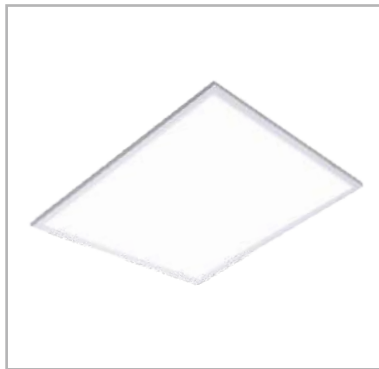

LIGHT SOURCE

LED Source : LED
 CCT : 4000K-6500K
 Wattage : 40 & 60 W
 Beam Angle : 120°
 CRI : 80Ra
 Lumen : 4000-6000lm
 Efficacy : 100lm/W
 Dimming Type : Dimmable/ Non Dimmable

HOUSING

Dimension : 597x597mm
 Body : Aluminium
 Cover : ACR
 Orientation : Fixed
 IP Rating : IP 20

ARTO LED PANEL

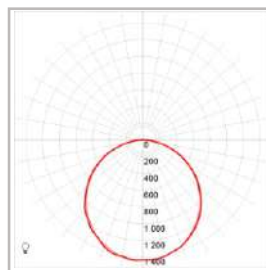
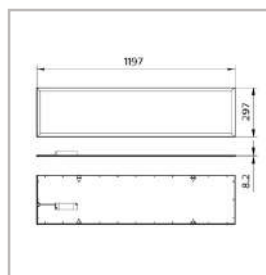
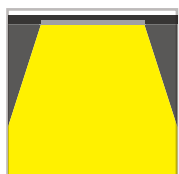

LIGHT SOURCE

LED Source : LED
 CCT : 4000K-6500K
 Wattage : 40 & 60 W
 Beam Angle : 120°
 CRI : 80Ra
 Lumen : 4000-6000lm
 Efficacy : 100lm/W
 Dimming Type : Dimmable/ Non Dimmable

HOUSING

Dimension : 1197x297mm
 Body : Aluminium
 Cover : ACR
 Orientation : Fixed
 IP Rating : IP 20

V SHAPE

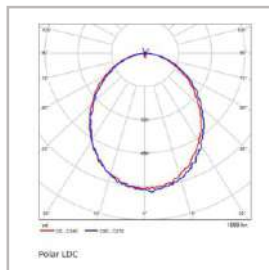
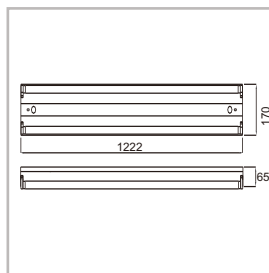
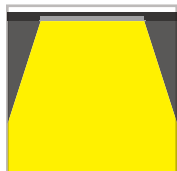

LIGHT SOURCE

LED Source : TL-LED
 CCT : 4000K-6500K
 Wattage : 8-18 W
 Beam Angle : 160°
 CRI : 80Ra
 Lumen : 1050-2100lm
 Efficacy : 130lm/W
 Dimming Type : Non Dimmable

HOUSING

Dimension : 1 x 615 & 1222mm
 2 x 615 & 1222mm
 3 x 615 & 1222mm
 Body : Steel Plate
 Orientation : Fixed
 IP Rating : IP 20

TK CG

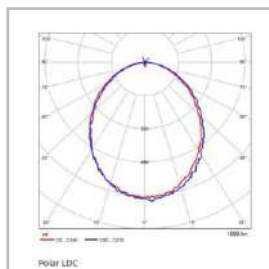
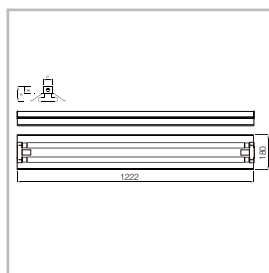
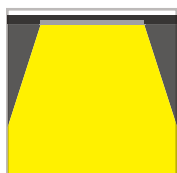

LIGHT SOURCE

LED Source : TL-LED
 CCT : 4000K-6500K
 Wattage : 8-18 W
 Beam Angle : 160°
 CRI : 80Ra
 Lumen : 1050-2100lm
 Efficacy : 130lm/W
 Dimming Type : Non Dimmable

HOUSING

Dimension : 1 x 615 & 1222mm
 2 x 615 & 1222mm
 Body : Steel Plate
 Orientation : Fixed
 IP Rating : IP 20

BL CG

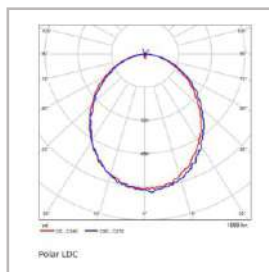
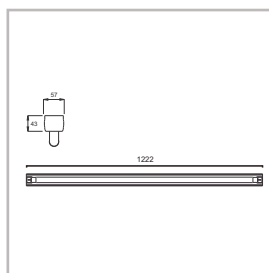

LIGHT SOURCE

LED Source : TL-LED
 CCT : 4000K-6500K
 Wattage : 8-18 W
 Beam Angle : 160°
 CRI : 80Ra
 Lumen : 1050-2100lm
 Efficacy : 130lm/W
 Dimming Type : Non Dimmable

HOUSING

Dimension : 1 x 615 & 1222mm
 2 x 615 & 1222mm
 Body : Steel Plate
 Orientation : Fixed
 IP Rating : IP 20

BL OSTA

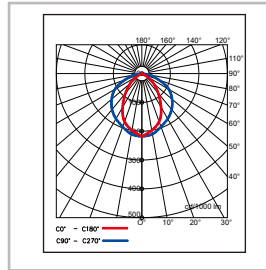
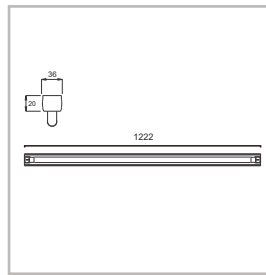
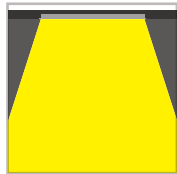
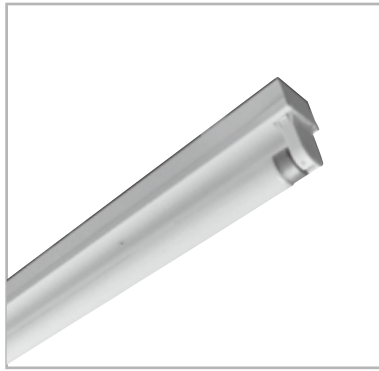

LIGHT SOURCE

LED Source : TL-LED
 CCT : 4000K-6500K
 Wattage : 8-18 W
 Beam Angle : 160°
 CRI : 80Ra
 Lumen : 1050-2100lm
 Efficacy : 130lm/W
 Dimming Type : Non Dimmable

HOUSING

Dimension : 1 x 615 & 1222mm
 2 x 615 & 1222mm
 Body : Steel Plate
 Orientation : Fixed
 IP Rating : IP 20

GMS TP

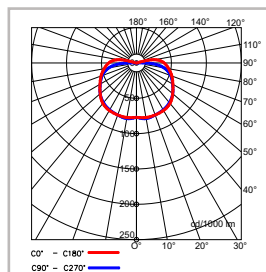
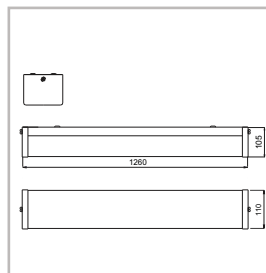
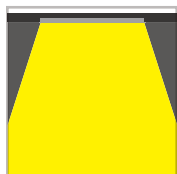

LIGHT SOURCE

LED Source : TL-LED
 CCT : 4000K-6500K
 Wattage : 8-18 W
 Beam Angle : 160°
 CRI : 80Ra
 Lumen : 1050-2100lm
 Efficacy : 130lm/W
 Dimming Type : Non Dimmable

HOUSING

Dimension : 615 & 1260mm
 Body : Steel Plate
 Cover : ACR
 Finishing : Powder Coating
 Orientation : Fixed
 IP Rating : IP 20

GMS CG

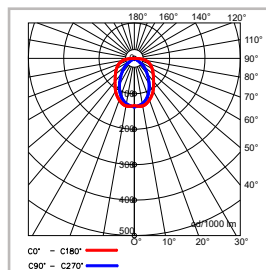
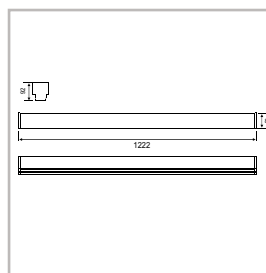
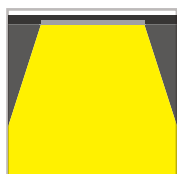

LIGHT SOURCE

LED Source : TL-LED
 CCT : 4000K-6500K
 Wattage : 8-18 W
 Beam Angle : 160°
 CRI : 80Ra
 Lumen : 1050-2100lm
 Efficacy : 130lm/W
 Dimming Type : Non Dimmable

HOUSING

Dimension : 615 & 1222mm
 Body : Steel Plate
 Cover : ACR
 Orientation : Fixed
 IP Rating : IP 20



TRACK SPOTLIGHT

For Track Lighting

SPOT RIO

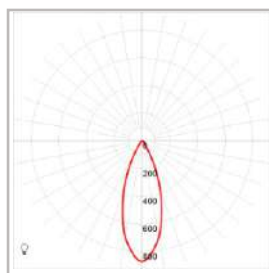
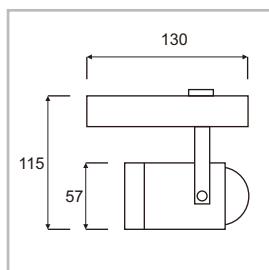
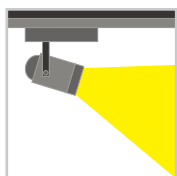

LIGHT SOURCE

LED Source : MR 16
 CCT : 2700K-6500K
 Wattage : 4-12 W
 Beam Angle : 15-36°
 CRI : 90Ra
 Lumen : 420-1210lm
 Efficacy : 110lm/W
 Dimming Type : Dimmable/ Non Dimmable

HOUSING

Dimension : 130 x 115mm
 Body : Die-Cast
 Accessories : Track spot
 Finishing : Powder Coating
 IP Rating : IP 20

SILINDRA ART

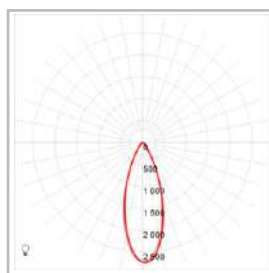
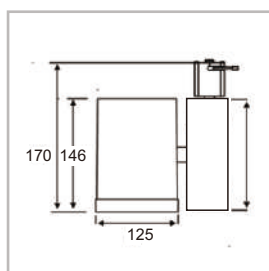
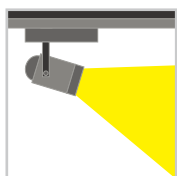

LIGHT SOURCE

LED Source : COB 111
 CCT : 2700K-6500K
 Wattage : 18-37 W
 Beam Angle : 15-60°
 CRI : 80-90Ra
 Lumen : 1472-4337lm
 Efficacy : up to 120lm/W
 Dimming Type : Dimmable

HOUSING

Dimension : 118 x 165mm
 Body : Die-Cast Aluminium
 Accessories : Track spot
 Finishing : Powder Coating
 IP Rating : IP 20



INDUSTRIAL

For General Lighting

WEATHERPROOF ELEKTRA

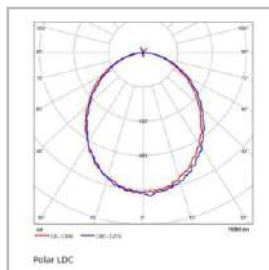
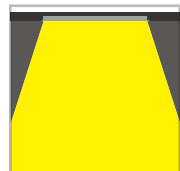
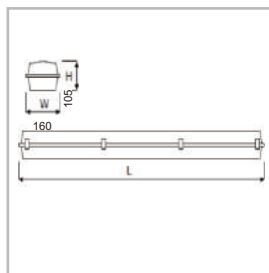

LIGHT SOURCE

LED Source : TL-LED
 CCT : 4000K-6500K
 Wattage : 8-18 W
 Beam Angle : 160°
 CRI : 80Ra
 Lumen : 1050-2100lm
 Efficacy : 130lm/W
 Dimming Type : Non Dimmable

HOUSING

Dimension : 635 & 1270mm
 Body : Plastic ABS
 Cover : Polycarbonate
 IP Rating : IP 65

INDUSTRIAL HIGHBAY UFO HM

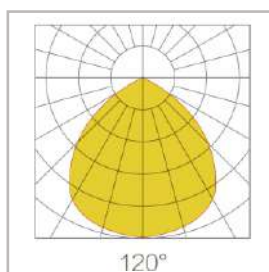
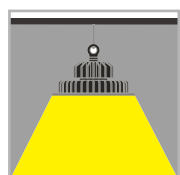
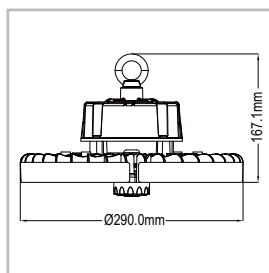

LIGHT SOURCE

LED Source : Highbright
 CCT : 3000K-6000K
 Wattage : 100-200 W
 Input : AC 100-277VAC, 50-60Hz
 Beam Angle : 70°/90°/120°
 CRI : 80Ra
 Lumen : 15.000-40.000lm
 Efficacy : 150lm/W
 Dimming Type : 0-10V/ DALI Control

HOUSING

Dimension : 35,70 x 1150 mm
 Body : ADC 12 Aluminium
 Finishing : Powder Coating
 Orientation : Fixed
 IP Rating : IP 65

INDUSTRIAL LIGHT 1B

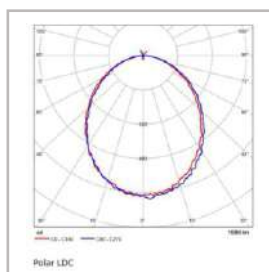
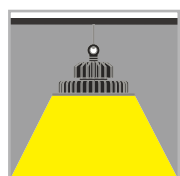
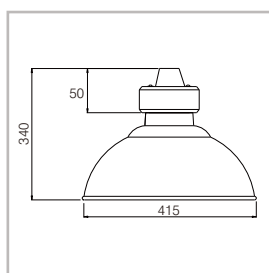

LIGHT SOURCE

LED Source : Led Bulb/Tforce
 CCT : 3000K-6500K
 Wattage : 30-50 W
 Beam Angle : 120°
 CRI : 80Ra
 Lumen : 3000-5000lm
 Efficacy : 100lm/W
 Dimming Type : Non Dimmable

HOUSING

Dimension : D 415 x H 340
 Body : Steel Plate
 Orientation : Non Adjustable
 IP Rating : IP 20

EXPLOSION PROOF SALUKA

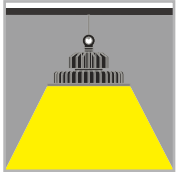
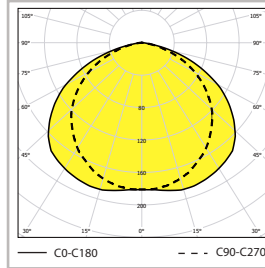
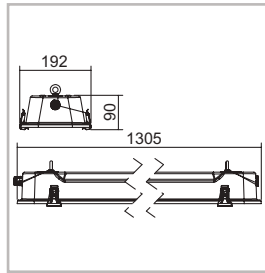

LIGHT SOURCE

LED Source : LED
 CCT : 2700K-6000K
 Wattage : 16W,33W,50W,66W,80W
 Input : 220-240 V/50-60 Hz AC/DC
 Beam Angle : 30°/60°/90°/120°
 CRI : 80Ra
 Lumen : up to 16.963lm
 Efficacy : 136lm/W
 Dimming Type : Dimmable/ non Dimmable

HOUSING

Dimension : 1305 x 192 x 90 mm
 Body : Painted steel housing RAL 9003
 Cover : Clear hardened safety glass OP
 Finishing : Powder Coating
 IP Rating : IP 66
 IK : IK 07
 Weight : 3,5~8,32 kg
 Zone Type : Zone 2, Zone 22

EXPLOSION PROOF EP-01-G1

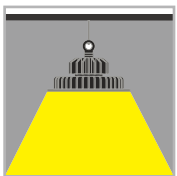
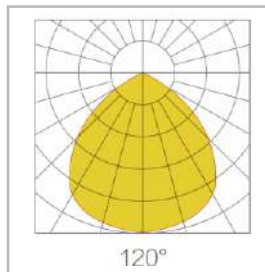
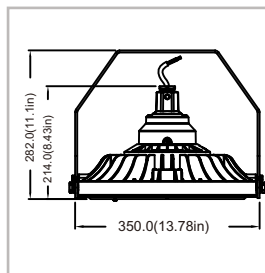

LIGHT SOURCE

LED Source : Lumileds 3030
 CCT : 3000K-6000K
 Wattage : 60-200 W
 Input : AC 100-277VAC, 50-60Hz
 Beam Angle : 30°/60°/90°/120°
 CRI : 80Ra
 Lumen : 8400-28.000lm
 Efficacy : 140lm/W
 Dimming Type : Non Dimmable

HOUSING

Dimension : 35,70 x 282 mm
 Body : Alumunium
 Finishing : Powder Coating
 Trim : Trim
 IP Rating : IP 66
 Weight : 9.0kg
 Zone Type : Zone 1, Zone 2, Zone 21, Zone 22

EXPLOSION PROOF EP-01-G3

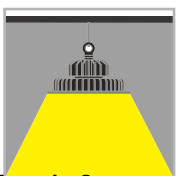
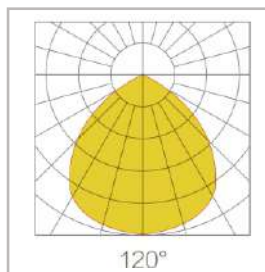
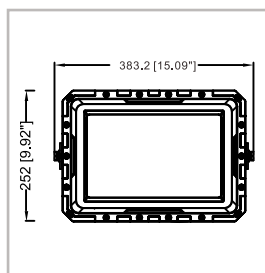

LIGHT SOURCE

LED Source : Lumileds 3030
 CCT : 4000K-6000K
 Wattage : 60-800 W
 Input : AC 100-277VAC, 50-60Hz
 Beam Angle : 30°/60°/90°/120°
 CRI : 95Ra
 Lumen : 7800-104.000lm
 Efficacy : 130lm/W
 Dimming Type : Non Dimmable

HOUSING

Dimension : 383.2 x 252mm ~ 537 x 842mm
 Body : Alumunium
 Finishing : Powder Coating
 Trim : Trim
 IP Rating : IP 66
 Weight : 10kg~48kg
 Zone Type : Zone 1, Zone 2, Zone 21, Zone 22



DECORATIVE
For Decorative Lighting

HL LUNAR 325

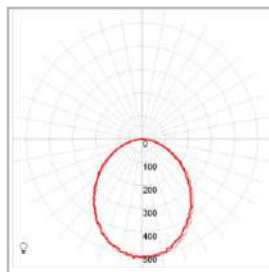
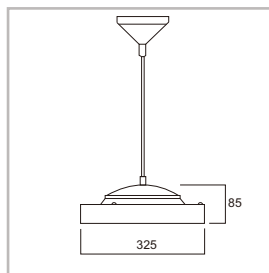
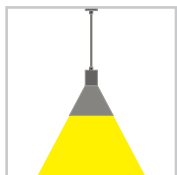

LIGHT SOURCE

LED Source : LED Star
 CCT : 4000K-6500K
 Wattage : 7-18 W
 Beam Angle : 120°
 CRI : 95Ra
 Lumen : 700-1800lm
 Efficacy : 100lm/W
 Dimming Type : Non Dimmable

HOUSING

Dimension : 325 x 85mm
 Body : Coated Steel Plate
 Cover : ACR
 IP Rating : IP 20

HL ASTO

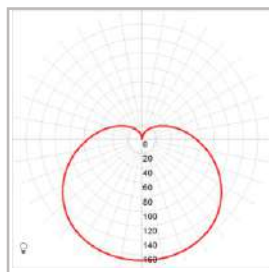
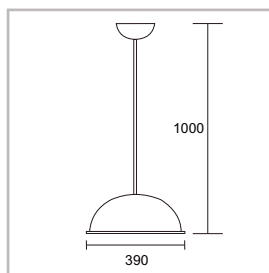
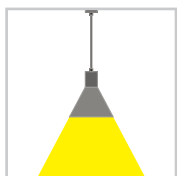

LIGHT SOURCE

LED Source : LED Bulb
 CCT : 3000K-6500K
 Wattage : 4-14.5 W
 Beam Angle : 120°
 CRI : 90Ra
 Lumen : 420-1800lm
 Efficacy : up to 120lm/W
 Dimming Type : Non Dimmable

HOUSING

Dimension : 390 x 1000mm
 Body : Aluminium
 IP Rating : IP 20

HL VANY E27

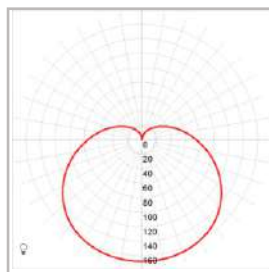
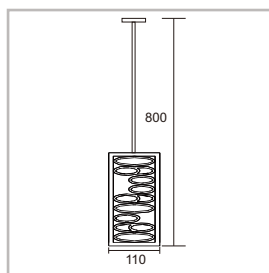
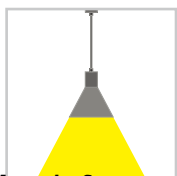

LIGHT SOURCE

LED Source : LED Bulb
 CCT : 3000K-6500K
 Wattage : 4-12 W
 Beam Angle : 120°
 CRI : 90Ra
 Lumen : 420-1360lm
 Efficacy : up to 120lm/W
 Dimming Type : Non Dimmable

HOUSING

Dimension : 390 x 1000mm
 Body : Aluminium
 IP Rating : IP 20

HL MALY

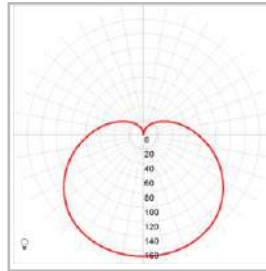
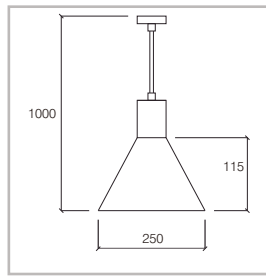
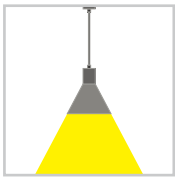

LIGHT SOURCE

LED Source : LED Bulb
 CCT : 3000K-6500K
 Wattage : 4-12 W
 Beam Angle : 120°
 CRI : 80Ra
 Lumen : 420-1360lm
 Efficacy : up to 120lm/W
 Dimming Type : Non Dimmable

HOUSING

Dimension : 250 x 1000mm
 Body : Steel Plate, ACR
 IP Rating : IP 20

HL STELO GLOBE C4

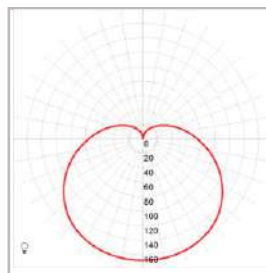
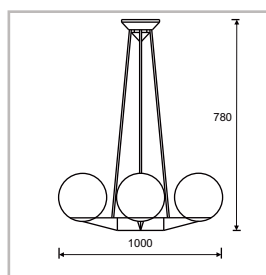
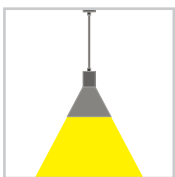

LIGHT SOURCE

LED Source : LED Bulb
 CCT : 3000K-6500K
 Wattage : 4-12 W
 Beam Angle : 120°
 CRI : 80Ra
 Lumen : 420-1360lm
 Efficacy : up to 120lm/W
 Dimming Type : Non Dimmable

HOUSING

Dimension : 1000 x 780mm
 Body : Steel Plate, Glass
 IP Rating : IP 20

HL JS 40 E27

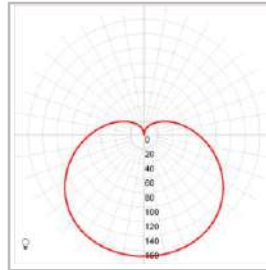
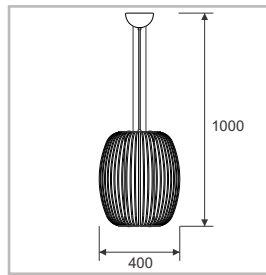

LIGHT SOURCE

LED Source : LED Bulb
 CCT : 3000K-6500K
 Wattage : 4-12 W
 Beam Angle : 120°
 CRI : 80Ra
 Lumen : 420-1360lm
 Efficacy : up to 120lm/W
 Dimming Type : Non Dimmable

HOUSING

Dimension : 400 x 1000mm
 Body : Coated Steel Plate
 Cover : ACR
 IP Rating : IP 20

HL JS 9 - 40 E27

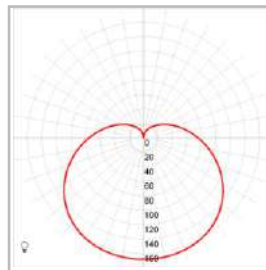
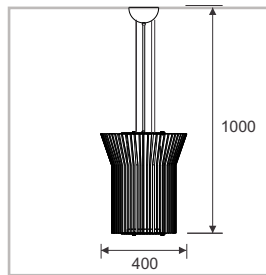
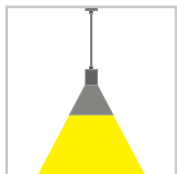

LIGHT SOURCE

LED Source : LED Bulb
 CCT : 3000K-6500K
 Wattage : 4-12 W
 Beam Angle : 120°
 CRI : 80Ra
 Lumen : 420-1360lm
 Efficacy : up to 120lm/W
 Dimming Type : Non Dimmable

HOUSING

Dimension : 400 x 1000mm
 Body : Aluminium
 IP Rating : IP 20

HL JS 7 - 40 E27

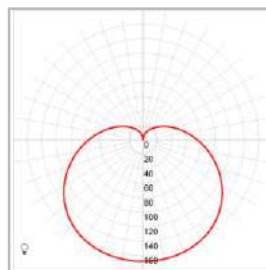
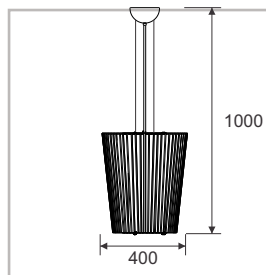
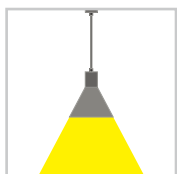

LIGHT SOURCE

LED Source : LED Bulb
 CCT : 3000K-6500K
 Wattage : 4-12 W
 Beam Angle : 120°
 CRI : 80Ra
 Lumen : 420-1360lm
 Efficacy : up to 120lm/W
 Dimming Type : Non Dimmable

HOUSING

Dimension : 400 x 1000mm
 Body : Aluminium
 IP Rating : IP 20



EXIT SIGNAGE
For Exit Signage

EXIT LED AL

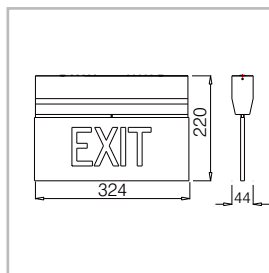

LIGHT SOURCE

LED Source	: LED
CCT	: 6500K
Wattage	: 3 W
Lumen	: 300lm
Efficacy	: 100lm/W
Dimming Type	: Non Dimmable

HOUSING

Dimension	: 324 x 220mm
Body	: Aluminium, ACR
IP Rating	: IP 20

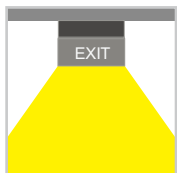

EXIT GREEN

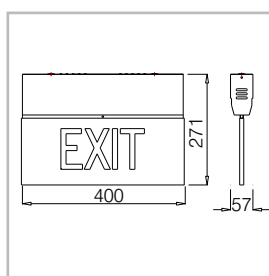

LIGHT SOURCE

LED Source	: TL T8
CCT	: 3000K-6500K
Wattage	: 8W
Lumen	: 800lm
Efficacy	: 100lm/W
Dimming Type	: Non Dimmable

HOUSING

Dimension	: 400 x 271mm
Body	: Steel Plate, Acr
IP Rating	: IP 20

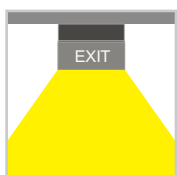

EXIT GREEN 220

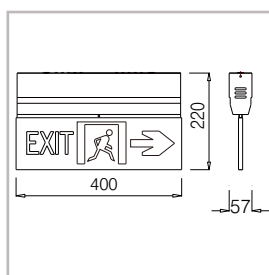

LIGHT SOURCE

LED Source	: TL T8
CCT	: 3000K-6500K
Wattage	: 8W
Lumen	: 800lm
Efficacy	: 100lm/W
Dimming Type	: Non Dimmable

HOUSING

Dimension	: 400 x 271mm
Body	: Steel Plate, Acr
IP Rating	: IP 20

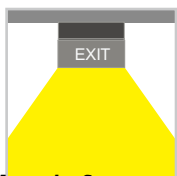

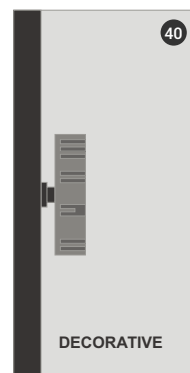
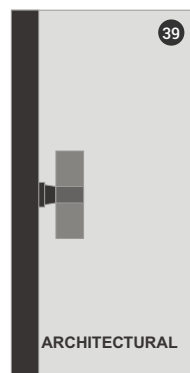

TUBA UP/DOWN 108

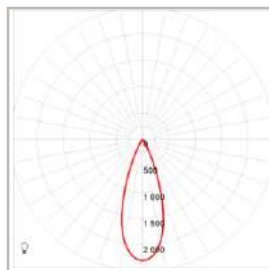
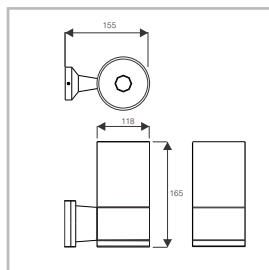
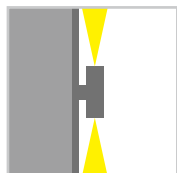

LIGHT SOURCE

LED Source : LED Bulb/ PAR30/ MR 16
 CCT : 4000K-6500K
 Wattage : 4-12W/20-40W
 Beam Angle : 120°/15-30°
 CRI : 80Ra
 Lumen : 420-4200lm
 Efficacy : 105lm/W
 Dimming Type : Dimmable/ Non Dimmable

HOUSING

Dimension : 118 x 165 x 155mm
 Body : Die-Cast Aluminium
 Cover : Tempered Glass
 Finishing : Powder Coating
 IP Rating : IP 65

TUBA UP & DOWN 108

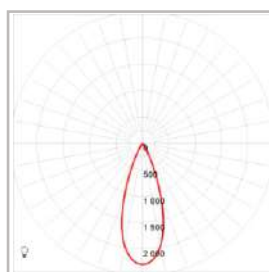
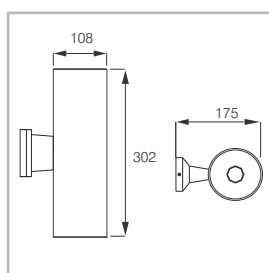
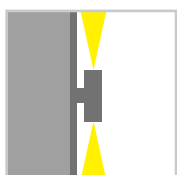

LIGHT SOURCE

LED Source : LED Bulb/ PAR30/ MR 16
 CCT : 4000K-6500K
 Wattage : 4-12W/20-40W
 Beam Angle : 120°/15-30°
 CRI : 80Ra
 Lumen : 420-4200lm
 Efficacy : 105lm/W
 Dimming Type : Dimmable/ Non Dimmable

HOUSING

Dimension : 108 x 302 x 175mm
 Body : Die-Cast Aluminium
 Cover : Tempered Glass
 Finishing : Powder Coating
 IP Rating : IP 65

TUBA UP & DOWN 118

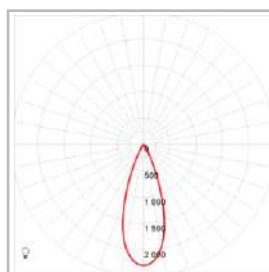
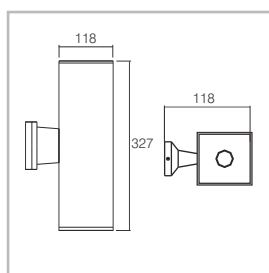
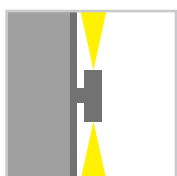

LIGHT SOURCE

LED Source : LED Bulb/ PAR30
 CCT : 4000K-6500K
 Wattage : 4-12W/20-40W
 Beam Angle : 120°/15-30°
 CRI : 80Ra
 Lumen : 420-4200lm
 Efficacy : 105lm/W
 Dimming Type : Non Dimmable

HOUSING

Dimension : 118 x 327 X 118mm
 Body : Die-Cast Aluminium
 Cover : Tempered Glass
 Finishing : Powder Coating
 IP Rating : IP 65

WL ELENA

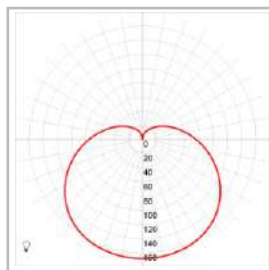
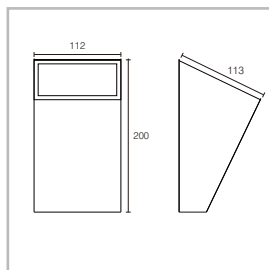
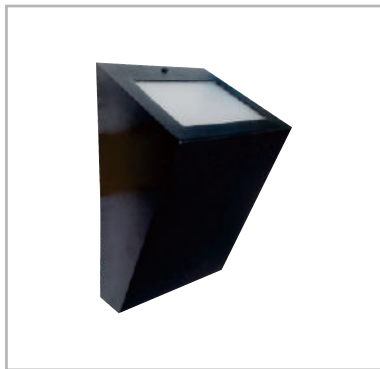

LIGHT SOURCE

LED Source : LED Bulb
 CCT : 3000K-6500K
 Wattage : 4-12 W
 Beam Angle : 120°
 CRI : 80Ra
 Lumen : 420-1360lm
 Efficacy : up to 120lm/W
 Dimming Type : Non Dimmable

HOUSING

Dimension : 112 x 200mm
 Body : Steel Plate
 Cover : ACR
 IP Rating : IP 20

WL VANY

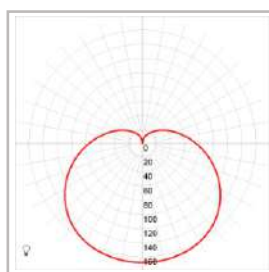
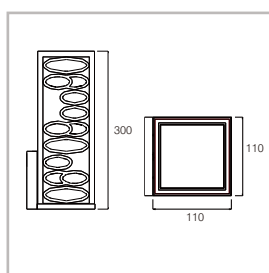
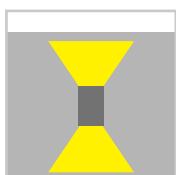

LIGHT SOURCE

LED Source : LED Bulb
 CCT : 3000K-6500K
 Wattage : 4-12 W
 Beam Angle : 120°
 CRI : 80Ra
 Lumen : 420-1360lm
 Efficacy : up to 120lm/W
 Dimming Type : Non Dimmable

HOUSING

Dimension : 110 x 300mm
 Body : Steel Plate
 Cover : ACR
 IP Rating : IP 20

WL BALCONY

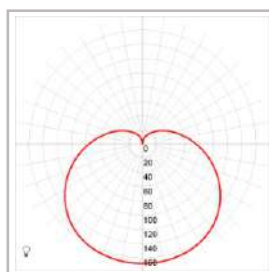
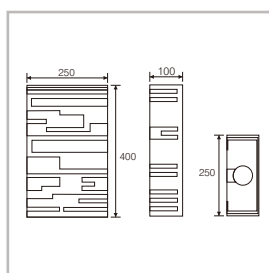
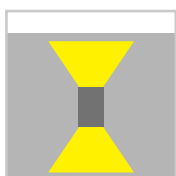

LIGHT SOURCE

LED Source : LED Bulb
 CCT : 3000K-6500K
 Wattage : 4-12 W
 Beam Angle : 120°
 CRI : 80Ra
 Lumen : 420-1360lm
 Efficacy : up to 120lm/W
 Dimming Type : Non Dimmable

HOUSING

Dimension : 250 x 400mm
 Body : Steel Plate
 Cover : ACR
 IP Rating : IP 20

TL ARTOLITE

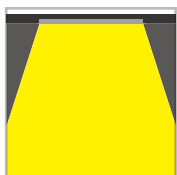
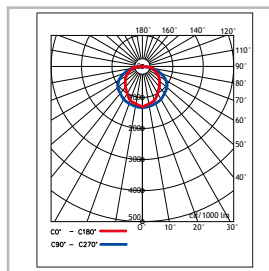
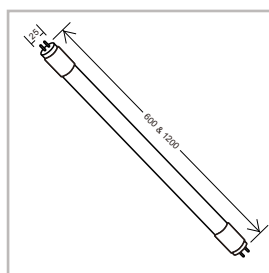
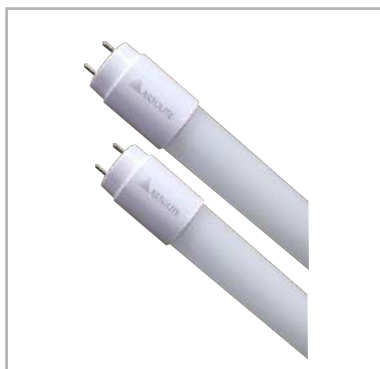

LIGHT SOURCE

LED Source : LED
 CCT : 6000K-6500K
 Wattage : 9 & 18 W
 Beam Angle : 160°
 CRI : 80Ra
 Lumen : 1077-2085lm
 Efficacy : 100lm/W
 Dimming Type : Non Dimmable

HOUSING

Dimension : 600 & 1200mm
 Body : Glass
 IP Rating : IP 20

LED LUXTRON LTX

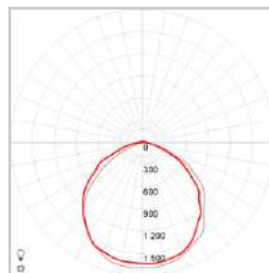
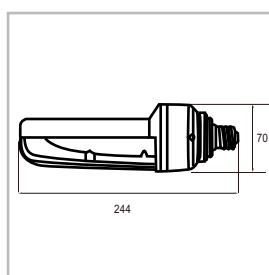

LIGHT SOURCE

LED Source : SMD 2835
 CCT : 3000K-6500K
 Wattage : 45W, 55W
 Holder : E27/E40
 Beam Angle : 200 °
 CRI : 80Ra
 Lumen : 6750lm
 Efficacy : 105lm/W
 Dimming Type : Non Dimmable

HOUSING

Dimension : 244 x 70mm
 Body : Aluminium Heatsink
 Cover : PC
 Input Voltage : AC 85-265V (50-60Hz)
 IP Rating : IP 65
 Weight : 0.7 kg



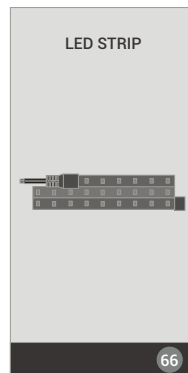
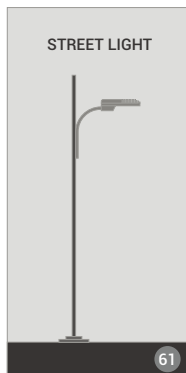
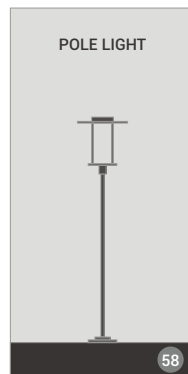
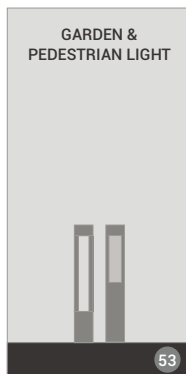
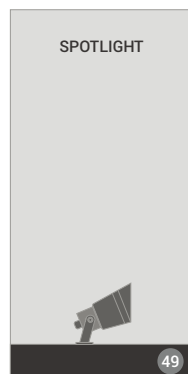
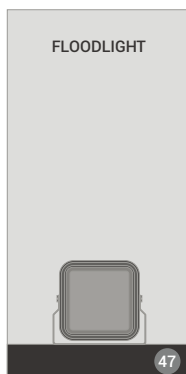



ARCHITECTURAL

For Architectural Lighting



SPOT BEADS

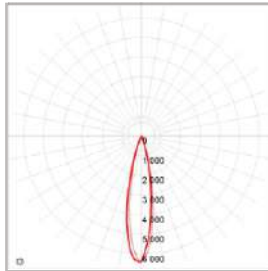
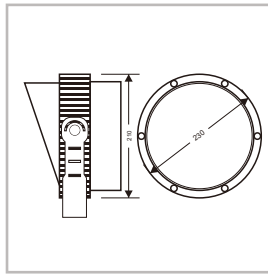
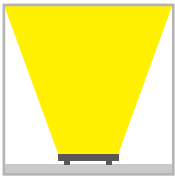

LIGHT SOURCE

LED Source : LED
 CCT : RGB
 Wattage : 20W, 30W
 Beam Angle : 30 °
 CRI : 90Ra
 Lumen : 1400-2400lm
 Efficacy : 60-70lm/W
 Dimming Type : DMX 512

HOUSING

Dimension : D 230 mm x H 210 mm
 Finishing : Powder Coating
 Material : Die Cast Aluminium
 Orientation : Fixed
 IP Rating : IP66

ARTO LOREBY

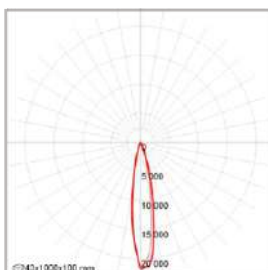
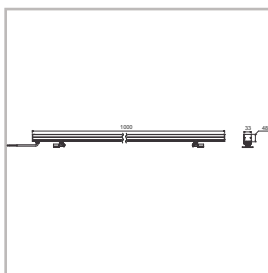
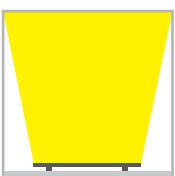

LIGHT SOURCE

LED Source : LED
 CCT : Mono Color, RGB
 Wattage : 24W, 36W, 48W
 Beam Angle : 30 °
 CRI : 90Ra
 Lumen : 1680-3840lm
 Efficacy : 70-80lm/W
 Dimming Type : DMX 512

HOUSING

Dimension : W 1000 mm x H 48 mm
 x D 33mm
 Finishing : Powder Coating
 Material : Die Cast Aluminium
 Cover : Tempered Glass
 Orientation : Fixed
 IP Rating : IP66



FLOOD LIGHT
For General Lighting

ARTO FLIX

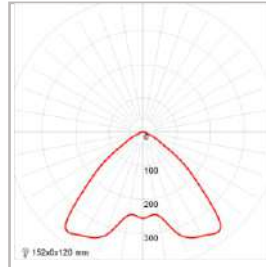
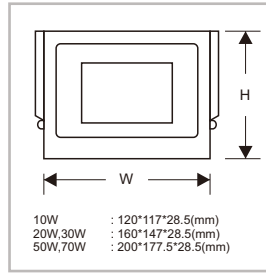
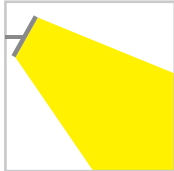

LIGHT SOURCE

LED Source : SMD 2835
CCT : 6500K
Wattage : 10W, 20W, 30W, 50W, 70W
Beam Angle : 110°
CRI : 70Ra
Lumen : 1100-7700lm
Efficacy : 110lm/W
Dimming Type : Non Dimmable

HOUSING

Dimension : W 200 mm x H 177 mm
Finishing : Powder Coating
Material : Die Cast Aluminium
Orientation : Adjustable
IP Rating : IP66

ARTO SLATE

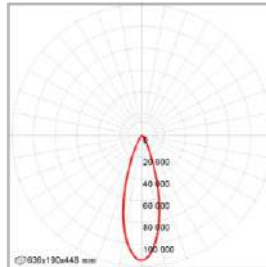
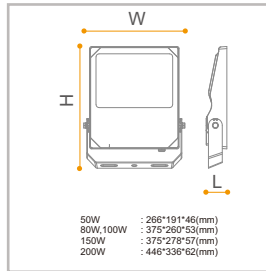
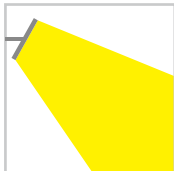

LIGHT SOURCE

LED Source : Lumileds
CCT : 4000K-5700K
Wattage : 50W,80W,100W,150W,200W
Beam Angle : 60/90/110°
CRI : 70Ra
Lumen : 7000-28000lm
Efficacy : 140lm/W
Dimming Type : 0-10V, DALI

HOUSING

Dimension : W 200 mm x H 177 mm
Finishing : Powder Coating
Material : Die Cast Aluminium
Orientation : Adjustable
IP Rating : IP66

ARTO FLOOD P5

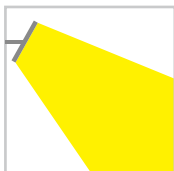

Dimension (mm)			
TYPE	L	W	H
150W	282.5	295	112
200W	452.5	295	121
240W	452.5	295	121
300W	452.5	295	121
450W	622.0	295	121
600W	517.5	600	185
720W	605.2	600	185
960W	772.5	600	185
1200W	942.5	600	185
1440W	942.5	600	185

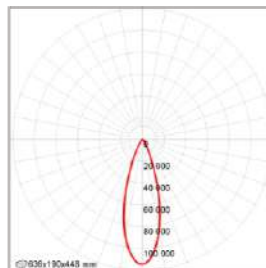

LIGHT SOURCE

LED Source : Lumileds
CCT : 3000K-5700K
Wattage : 150W,200W,240,300W
450W,600W,720W,960W
1200W,1440W
Beam Angle : 15/40°
CRI : 70Ra
Lumen : 19,500-187,200lm
Efficacy : 130lm/W
Dimming Type : 0-10V, DALI

HOUSING

Dimension : W 200 mm x H 177 mm
Finishing : Powder Coating
Material : Die Cast Aluminium
Orientation : Fixed
IP Rating : IP66



SPOTLIGHT
For Accent Lighting

SPOT MARESCA

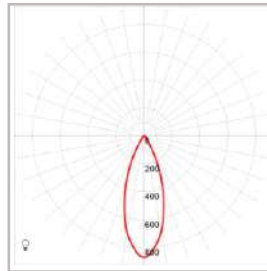
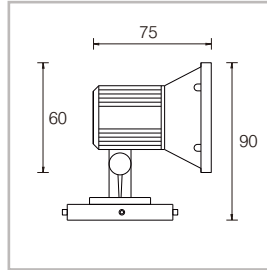
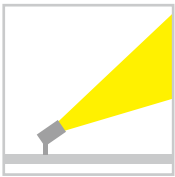

LIGHT SOURCE

LED Source : MR 16
 CCT : 2700K-6500K
 Wattage : 4-12W
 Beam Angle : 15°, 24°, 36°
 CRI : 90Ra
 Lumen : 400-1200lm
 Efficacy : 100lm/W
 Dimming Type : Dimmable/Non-Dimmable

HOUSING

Dimension : W 120 x H 90 mm
 Finishing : Powder Coating
 Material : Die Cast Aluminium
 Orientation : Adjustable
 IP Rating : IP66

SPOT LEDS Z537

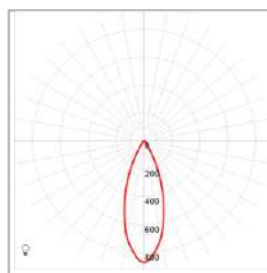
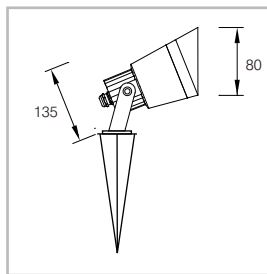
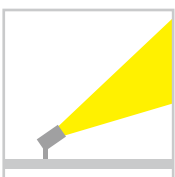

LIGHT SOURCE

LED Source : MR 16
 CCT : 2700K-6500K
 Wattage : 4-12W
 Beam Angle : 15°, 24°, 36°
 CRI : 90Ra
 Lumen : 400-1200lm
 Efficacy : 100lm/W
 Dimming Type : Dimmable/Non-Dimmable

HOUSING

Dimension : W 135 x H 80 mm
 Finishing : Powder Coating
 Material : Die Cast Aluminium
 Orientation : Adjustable
 IP Rating : IP66

XEON STRIPE

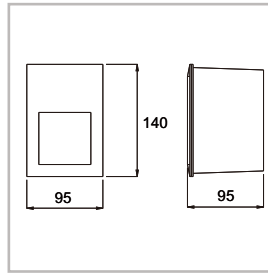

LIGHT SOURCE

LED Source : PCB LED
CCT : 3000K
Wattage : 3W
CRI : 80Ra
Lumen : 300lm
Efficacy : 100lm/W
Dimming Type : Non-Dimmable

HOUSING

Dimension : W 95 x H 140 mm
Finishing : Powder Coating
Material : Die Cast Aluminium
Orientation : Fixed
IP Rating : IP54

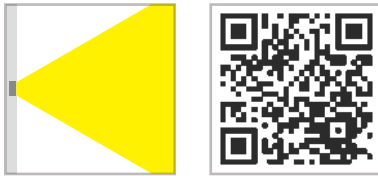

XEON SLIM

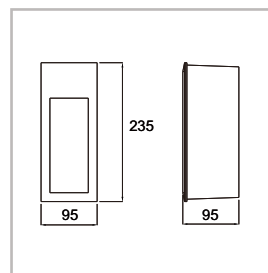

LIGHT SOURCE

LED Source : PCB LED
CCT : 3000K
Wattage : 3W
CRI : 80Ra
Lumen : 300lm
Efficacy : 100lm/W
Dimming Type : Non-Dimmable

HOUSING

Dimension : W 95 x H 235 mm
Finishing : Powder Coating
Material : Die Cast Aluminium
Orientation : Fixed
IP Rating : IP54

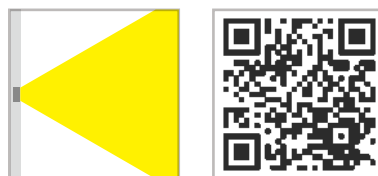

XEON FLAT

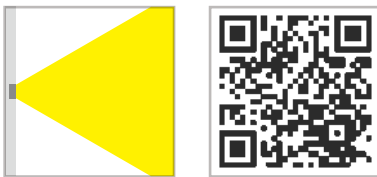
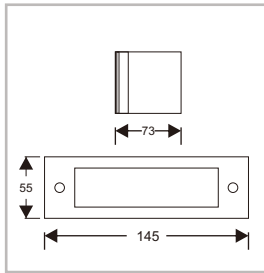

LIGHT SOURCE

LED Source	: PCB LED
CCT	: 3000K
Wattage	: 3W
CRI	: 80Ra
Lumen	: 300lm
Efficacy	: 100lm/W
Dimming Type	: Non-Dimmable

HOUSING

Dimension	: W 145 x H 55 mm
Finishing	: Powder Coating
Material	: Die Cast Aluminium
Orientation	: Fixed
IP Rating	: IP54

WL PARKING 340

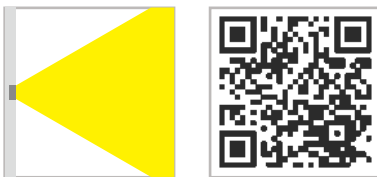
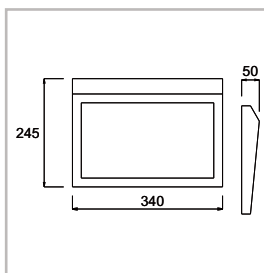

LIGHT SOURCE

LED Source	: PCB LED
CCT	: 3000K-6000K
Wattage	: 6W
CRI	: 80Ra
Lumen	: 600lm
Efficacy	: 100lm/W
Dimming Type	: Non-Dimmable

HOUSING

Dimension	: W 340 x H 245 mm
Finishing	: Powder Coating
Material	: Steel Plate
Cover	: ACR
Orientation	: Fixed
IP Rating	: IP54



GARDEN & PEDESTRIAN LIGHT For Garden and Pedestrian Lighting

GL LUNAR 150 ACR

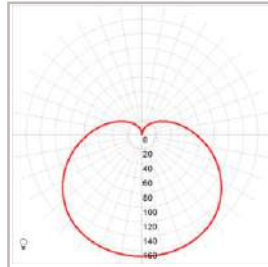
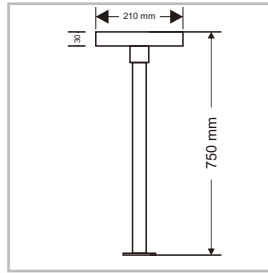

LIGHT SOURCE

LED Source : PCB LED
 CCT : 4000K-6000K
 Wattage : 12-15W
 Beam Angle : 120°
 CRI : 95Ra
 Lumen : 700-1200lm
 Efficacy : 100lm/W
 Dimming Type : Non-Dimmable

HOUSING

Dimension : W 210 x H 750 mm
 Finishing : Powder Coating
 Material : Steel Pipe
 Orientation : Fixed
 IP Rating : IP65

GL SQ 90-150

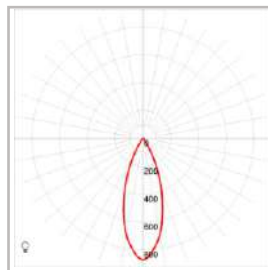
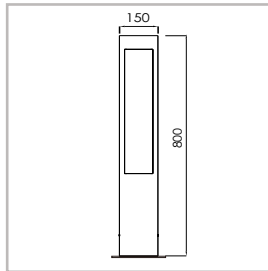
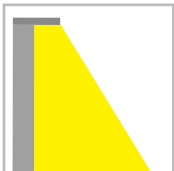

LIGHT SOURCE

LED Source : MR 16 / COB 50
 CCT : 2700K-6500K
 Wattage : 4-12W
 Beam Angle : 15°, 24°, 36°, 40°
 CRI : 90Ra
 Lumen : 400-1200lm
 Efficacy : 100lm/W
 Dimming Type : Dimmable/Non-Dimmable

HOUSING

Dimension : W 150 x H 800 mm
 Finishing : White Powder Coating
 Material : Steel Plate
 Orientation : Fixed
 IP Rating : IP65

GL ARBE MINI

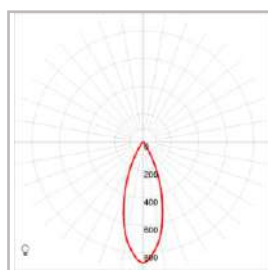
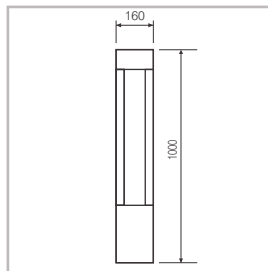
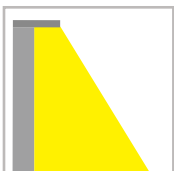

LIGHT SOURCE

LED Source : MR 16 / COB 50
 CCT : 2700K-6500K
 Wattage : 4-12W
 Beam Angle : 15°, 24°, 36°, 40°
 CRI : 90Ra
 Lumen : 400-1200lm
 Efficacy : 100lm/W
 Dimming Type : Dimmable/Non-Dimmable

HOUSING

Dimension : W 160 x H 1000 mm
 Finishing : White Powder Coating
 Material : Steel Plate
 Orientation : Fixed
 IP Rating : IP65

GL ELENA 100

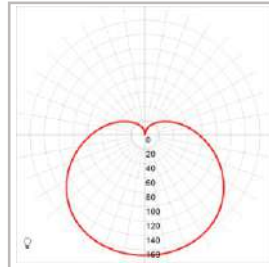
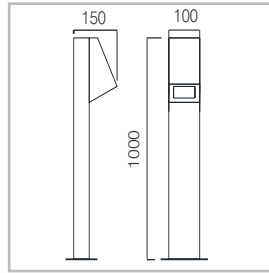
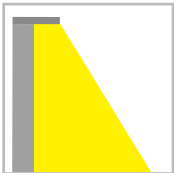

LIGHT SOURCE

LED Source : LED Bulb
 CCT : 3000K-6500K
 Wattage : 4-12W
 Beam Angle : 120°
 CRI : 80Ra
 Lumen : 420-1360lm
 Efficacy : up to 120lm/W
 Dimming Type : Non-Dimmable

HOUSING

Dimension : W 150 x H 1000 mm
 Finishing : Powder Coating
 Material : Steel Pipe
 Cover : ACR
 Orientation : Fixed
 IP Rating : IP65

GL SQ 135 E27

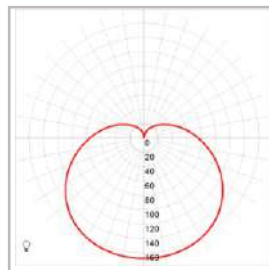
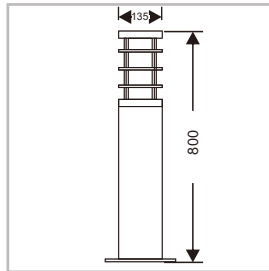

LIGHT SOURCE

LED Source : LED Bulb
 CCT : 3000K-6500K
 Wattage : 4-12W
 Beam Angle : 120°
 CRI : 80Ra
 Lumen : 420-1360lm
 Efficacy : up to 120lm/W
 Dimming Type : Non-Dimmable

HOUSING

Dimension : W 35 x H 800 mm
 Finishing : Powder Coating
 Material : Steel Pipe
 Cover : ACR
 Orientation : Fixed
 IP Rating : IP65

PL BD 862 E27

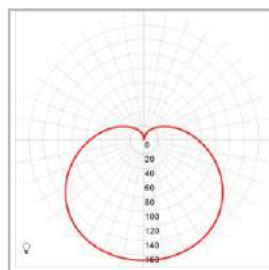
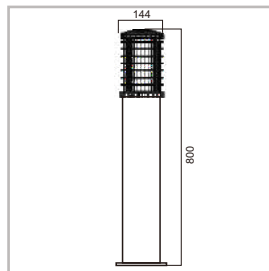
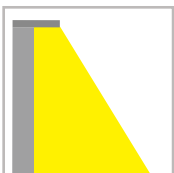

LIGHT SOURCE

LED Source : LED Bulb
 CCT : 3000K-6500K
 Wattage : 4-12W
 Beam Angle : 120°
 CRI : 80Ra
 Lumen : 420-1360lm
 Efficacy : up to 120lm/W
 Dimming Type : Non-Dimmable

HOUSING

Dimension : W 144 x H 800 mm
 Finishing : Powder Coating
 Material : PVC
 Cover : ACR
 Orientation : Fixed
 IP Rating : IP65

GL PILAR DAIKO

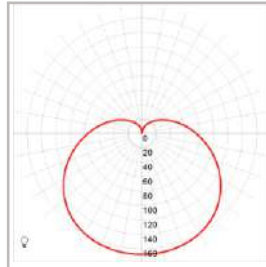
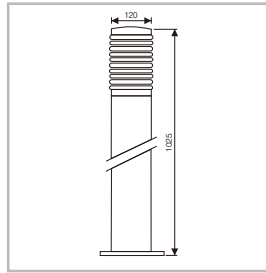
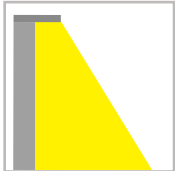

LIGHT SOURCE

LED Source : LED Bulb
 CCT : 3000K-6500K
 Wattage : 4-12W
 Beam Angle : 120°
 CRI : 80Ra
 Lumen : 420-1360lm
 Efficacy : up to 120lm/W
 Dimming Type : Non-Dimmable

HOUSING

Dimension : W 120 x H 1025 mm
 Finishing : Powder Coating
 Material : PVC
 Cover : Glass/ACR
 Orientation : Fixed
 IP Rating : IP65

GL PILAR DAIKO SQ

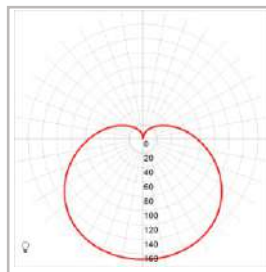
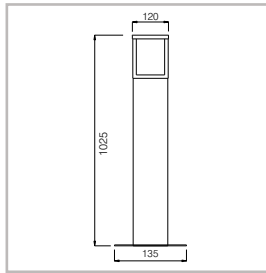

LIGHT SOURCE

LED Source : LED Bulb
 CCT : 3000K-6500K
 Wattage : 4-12W
 Beam Angle : 120°
 CRI : 80Ra
 Lumen : 420-1360lm
 Efficacy : up to 120lm/W
 Dimming Type : Non-Dimmable

HOUSING

Dimension : W 120 x H 1025 mm
 Finishing : Powder Coating
 Material : Steel Plate
 Cover : Glass/ACR
 Orientation : Fixed
 IP Rating : IP65

GL STIMA 3-70

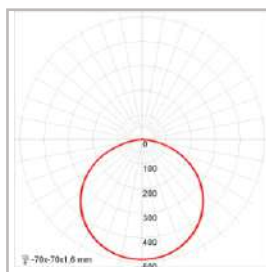
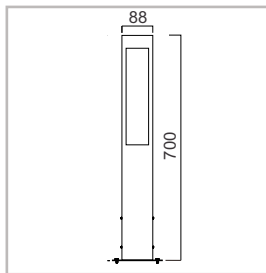
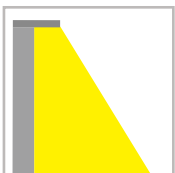

LIGHT SOURCE

LED Source : LED Linear
 CCT : 2700K-6500K
 Wattage : 7W
 Beam Angle : 120°
 CRI : 80Ra
 Lumen : 700lm
 Efficacy : 100lm/W
 Dimming Type : Non-Dimmable

HOUSING

Dimension : W 88 x H 700 mm
 Finishing : Powder Coating
 Material : Steel Pipe
 Cover : ACR
 Orientation : Fixed
 IP Rating : IP65

GL STIMA

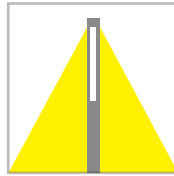
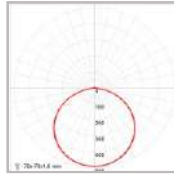
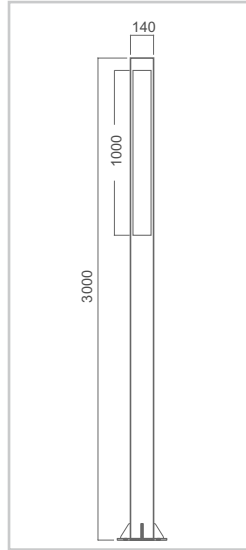

LIGHT SOURCE

LED Source : LED Linear
 CCT : 3000K-6500K
 Wattage : 24.5W
 Beam Angle : 120°
 CRI : 80Ra
 Lumen : 4843lm
 Efficacy : 168lm/W
 Dimming Type : Dimmable/ Non Dimmable

HOUSING

Dimension : W 140 x H 3000 mm
 Finishing : Powder Coating
 Material : Steel Pipe
 Cover : ACR
 Orientation : Fixed
 IP Rating : IP65

GL ARBE

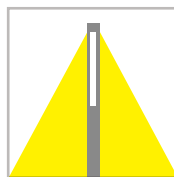
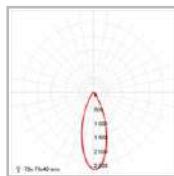
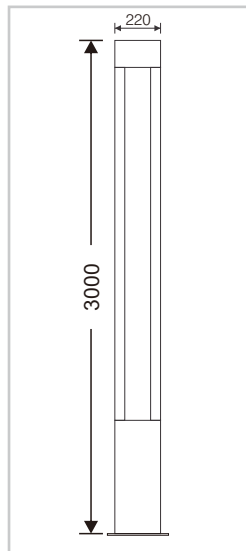

LIGHT SOURCE

LED Source : COB 111
 CCT : 3000K-6500K
 Wattage : 25-36W
 Beam Angle : 15°, 24°, 40°, 60°
 CRI : 80Ra
 Lumen : 1800-4800lm
 Efficacy : 130lm/W
 Dimming Type : Dimmable/ Non Dimmable

HOUSING

Dimension : W 220 x H 3000 mm
 Finishing : Powder Coating
 Material : Steel Pipe
 Orientation : Fixed
 IP Rating : IP65

GL OPTIC 350

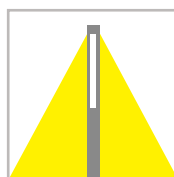
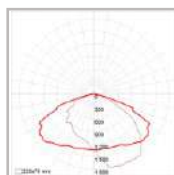

LIGHT SOURCE

LED Source : Module LED
 CCT : 4000K-6500K
 Wattage : 21,34,48W
 Beam Angle : 150°x80°
 CRI : 80Ra
 Lumen : up to 5900lm
 Efficacy : 120lm/W
 Dimming Type : Non-Dimmable

HOUSING

Dimension : W 290 x H 3000 mm
 Finishing : Powder Coating
 Material : Steel Plate
 Orientation : Fixed
 IP Rating : IP65

GL ZIGA LED

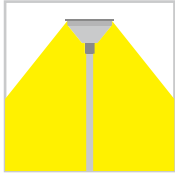
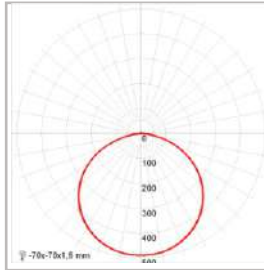
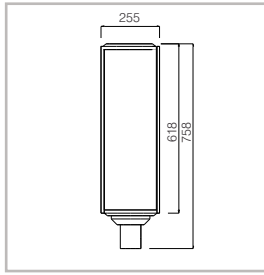

LIGHT SOURCE

LED Source : Linear LED
 CCT : 3000K-6500K
 Wattage : 2x12.3W
 Beam Angle : 120°
 CRI : 80Ra
 Lumen : 3120lm
 Efficacy : 130lm/W
 Dimming Type : Non-Dimmable

HOUSING

Dimension : W 255 x H 758 mm
 Finishing : Powder Coating
 Material : Steel Plate
 Cover : ACR
 Orientation : Fixed
 IP Rating : IP65

GL TOP ACR T

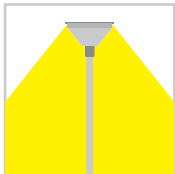
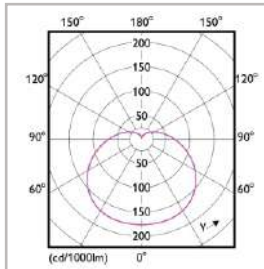
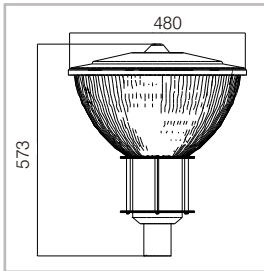

LIGHT SOURCE

LED Source : LED Bulb
 CCT : 3000K-6500K
 Wattage : 4-19W
 Beam Angle : 120°
 CRI : 80Ra
 Lumen : 420-2300lm
 Efficacy : up to 120lm/W
 Dimming Type : Non-Dimmable

HOUSING

Dimension : W 480 x H 573 mm
 Finishing : Powder Coating
 Material : Steel Plate
 Cover : ACR
 Orientation : Fixed
 IP Rating : IP65

GL TOP TRP

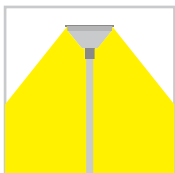
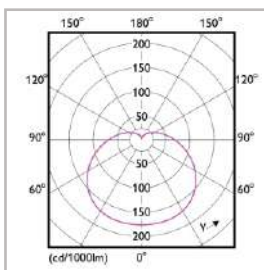
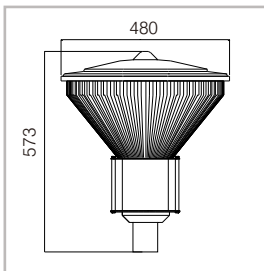

LIGHT SOURCE

LED Source : LED Bulb
 CCT : 3000K-6500K
 Wattage : 4-19W
 Beam Angle : 120°
 CRI : 80Ra
 Lumen : 420-2300lm
 Efficacy : up to 120lm/W
 Dimming Type : Non-Dimmable

HOUSING

Dimension : W 480 x H 573 mm
 Finishing : Powder Coating
 Material : Steel Pipe
 Cover : ACR
 Orientation : Fixed
 IP Rating : IP65

RL AJB Z LED

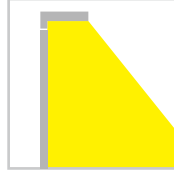
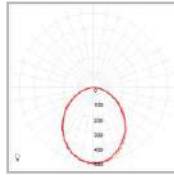
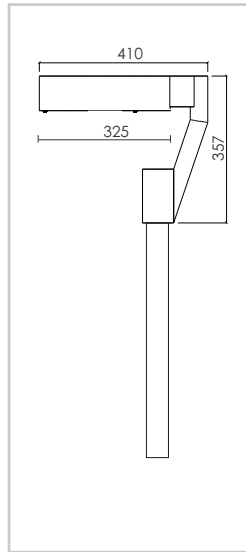

LIGHT SOURCE

LED Source	: PCB LED
CCT	: 4000K-6500K
Wattage	: 12-30W
Beam Angle	: 120°
CRI	: 95Ra
Lumen	: 1200-3000lm
Efficacy	: 100lm/W
Dimming Type	: Non-Dimmable

HOUSING

Dimension	: W 410 x H 357 mm
Finishing	: Powder Coating
Material	: Steel Plate
Cover	: ACR
Orientation	: Fixed
IP Rating	: IP65

RL AJB 325

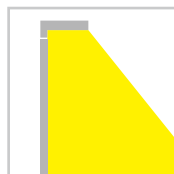
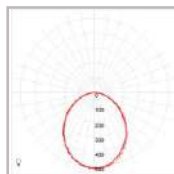
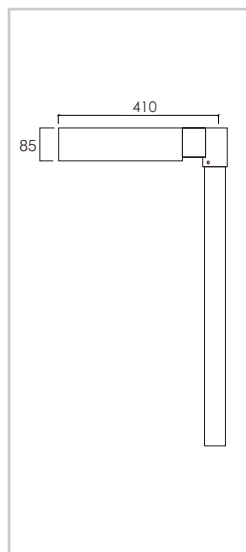

LIGHT SOURCE

LED Source	: PCB LED
CCT	: 4000K-6500K
Wattage	: 12-30W
Beam Angle	: 120°
CRI	: 95Ra
Lumen	: 1200-3000lm
Efficacy	: 100lm/W
Dimming Type	: Non-Dimmable

HOUSING

Dimension	: W 410 x H 85 mm
Finishing	: Powder Coating
Material	: Steel Plate
Cover	: ACR
Orientation	: Fixed
IP Rating	: IP65

GL BG

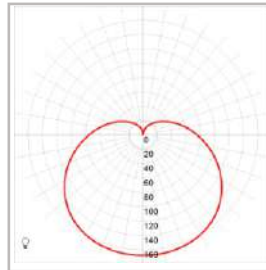
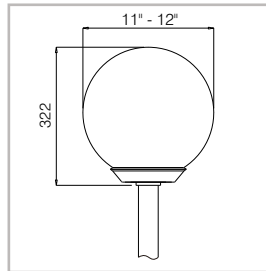
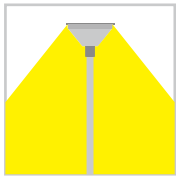

LIGHT SOURCE

LED Source : LED Bulb
 CCT : 2700K-6500K
 Wattage : 4-14.5W
 Beam Angle : 120°
 CRI : 80Ra
 Lumen : 400-1800lm
 Efficacy : up to 120lm/W
 Dimming Type : Non-Dimmable

HOUSING

Dimension : D 11"-12" x H 322 mm
 Finishing : Powder Coating
 Material : Steel Plate
 Cover : Glass
 Orientation : Fixed
 IP Rating : IP65

GL BIG CESSNA T

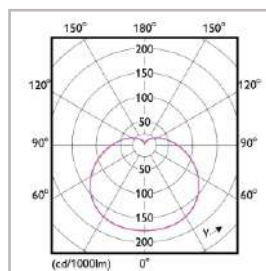
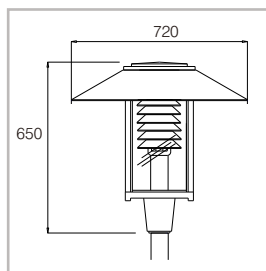
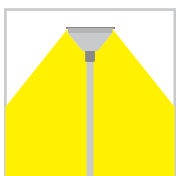

LIGHT SOURCE

LED Source : LED Bulb
 CCT : 2700K-6500K
 Wattage : 4-14.5W
 Beam Angle : 120°
 CRI : 80Ra
 Lumen : 400-1800lm
 Efficacy : up to 120lm/W
 Dimming Type : Non-Dimmable

HOUSING

Dimension : W 720 x H 650 mm
 Finishing : Powder Coating
 Material : Steel Plate
 Cover : Glass
 Orientation : Fixed
 IP Rating : IP65



STREET LIGHT
For Street Lighting

RL EXEL ALL IN ONE

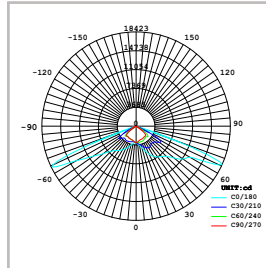
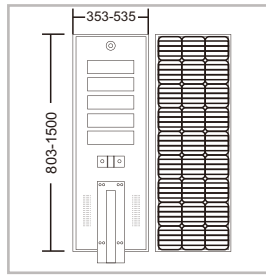

LIGHT SOURCE

LED Source	: SMD 3030
Battery	: LifePO4
Solar Panel	: Monocrystalline
CCT	: 6500K
Wattage	: 20,30,40,50,60,80,100,120W
Beam Angle	: 130x65°
CRI	: 80Ra
Lumen	: 3140-18.840lm
Efficacy	: 157lm/W
Dimming Type	: Dimmable

HOUSING

Dimension	: W 353-535 x H 803-1500 mm
Finishing	: Powder Coating
Material	: Aluminium
Orientation	: Fixed
IP Rating	: IP67

RL OPTICA P

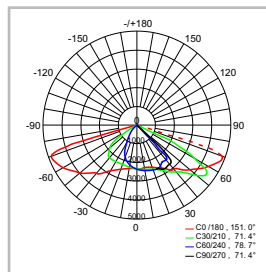
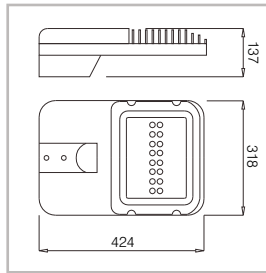

LIGHT SOURCE

LED Source	: LED
CCT	: 3000K-6500K
Wattage	: 40,60,80,90,100,120,150W
Beam Angle	: 150°x70°
CRI	: 70Ra
Lumen	: 4800-18.000lm
Efficacy	: 120lm/W
Dimming Type	: Dimmable/Non-Dimmable

HOUSING

Dimension	: W 424 x L 318 mm
Finishing	: Powder Coating
Material	: Die Cast Aluminium
Cover	: Glass
Orientation	: Fixed
IP Rating	: IP66

RL GINO

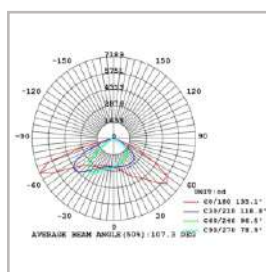
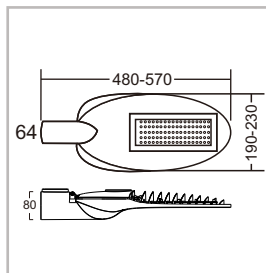

LIGHT SOURCE

LED Source	: Lumileds
Input Voltage	: 100 - 277Volt VAC 50/60Hz
CCT	: 4000K-6500K
Wattage	: 40,60,80,90,100,120 Watt
Beam Angle	: 150°x70°
CRI	: 70Ra
Lumen	: 4800-14.400lm
Efficacy	: 120lm
Dimming Type	: Dimmable/Non-Dimmable

HOUSING

Dimension	: W 480-570 x L 190-230 mm
Finishing	: Powder Coating
Material	: Die Cast Aluminium
Orientation	: Fixed
IP Rating	: IP67

RL OPTICA P + SOLAR PANEL

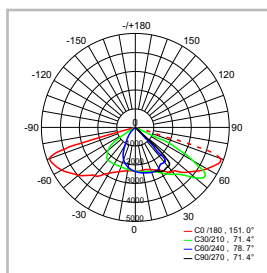
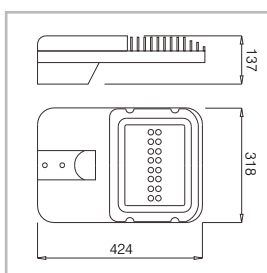

LIGHT SOURCE

LED Source	: LED
Solar Panel	: Poly/Mono Crystalline
Battery	: VRLA, LiFePO4
CCT	: 3000K-6500K
Wattage	: 40,60,80,90,100,120,150W
Beam Angle	: 150°x70°
CRI	: 70Ra
Lumen	: 4800-18.000lm
Efficacy	: 120lm/W
Dimming Type	: Dimmable/Non-Dimmable

HOUSING

Dimension	: W 424 x L 318 mm
Finishing Material	: Powder Coating
Material	: Die Cast Aluminium
Cover	: Glass
Orientation	: Fixed
IP Rating	: IP66

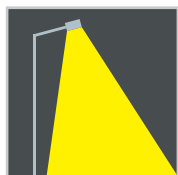

RL GINO + SOLAR PANEL

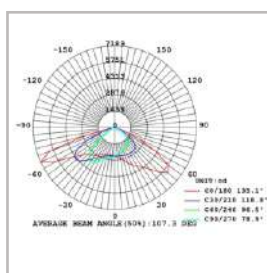
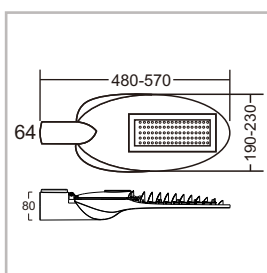

LIGHT SOURCE

LED Source	: Lumileds
Solar Panel	: Poly/Mono Crystalline
Battery	: VRLA, LiFePO4
Input Voltage	: 100 - 277Volt VAC 50/60Hz
CCT	: 4000K-6500K
Wattage	: 40,60,80,90,100,120 Watt
Beam Angle	: 150°x70°
CRI	: 70Ra
Lumen	: 4800-14.400lm
Efficacy	: 120lm/W
Dimming Type	: Dimmable/Non-Dimmable

HOUSING

Dimension	: W 480-570 x L 190-230 mm
Finishing Material	: Powder Coating
Material	: Die Cast Aluminium
Orientation	: Fixed
IP Rating	: IP67

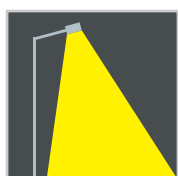

OCTAGON LIGHTING POLE

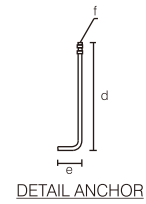
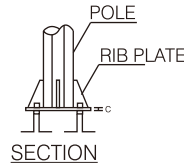
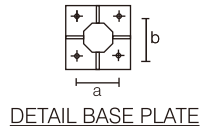
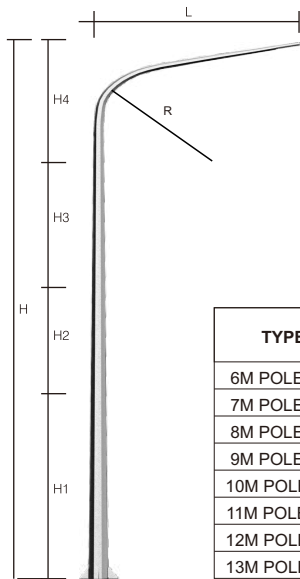

TYPE	HEIGHT (mm)					R	L	BOTTOM (mm)			BASE PLATE (mm)			ANCHOR (mm)			
	H	h1	h2	h3	Thk			b1	b2	b3	a	b	c	d	e	f	
6M POLE S/D	6000	3000	-	3300	3,2	1500	1800	136	125	19	300	200	12	500	100	16	
7M POLE S/D	7000	4000		3300				147	135								
8M POLE S/D	8000	5000		3300				157	145								
9M POLE S/D	9000	6000	-	3300				22	400	300	16	600	150	22			
10M POLE S/D	10000	3000	5000	2600											165	152	
11M POLE S/D	11000	4000	5000	2600											170	157	
12M POLE S/D	12000	5000	5000	2600				25	1800	2100	400	300	16	600	150	22	
13M POLE S/D	13000	6000	5000	2600	180	167											

ROUND LIGHTING POLE

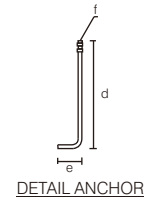
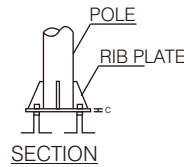
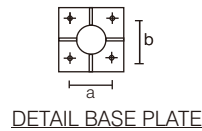
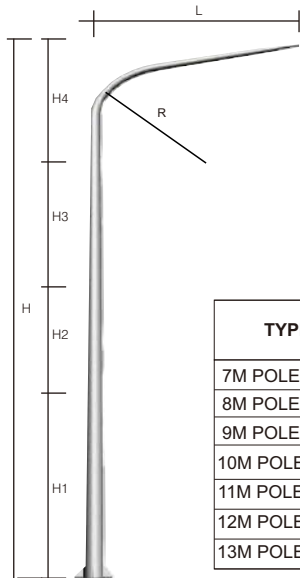

TYPE	HEIGHT (mm)					# PIPE (inches)				BASE PLATE (mm)			ANCHOR (mm)		
	H	h1	h2	h3	h4	h1	h2	h3	h4	a	b	c	d	e	f
7M POLE R S/D	7000	3000	-	2500	1500	4	-	3	2	300	200	12	500	100	16
8M POLE R S/D	8000	3000	-	3500	1500	4	-	3	2						
9M POLE R S/D	9000	3000	2850	1650	1500	5	4	3	2	400	300	16	600	150	19
10M POLE R S/D	10000	3000	2850	2650	1500	5	4	3	2						
11M POLE R S/D	11000	3000	2850	3650	1500	5	4	3	2						
12M POLE R S/D	12000	6000	2850	1650	1500	5	4	3	2				600	150	22
13M POLE R S/D	13000	6000	2850	2650	1500	5	4	3	2						

DOUBLE LIGHTING POLE ROUND/OCTAGONAL

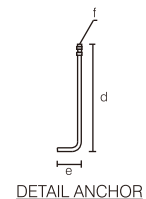
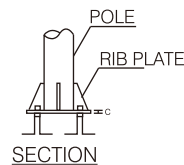
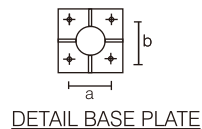
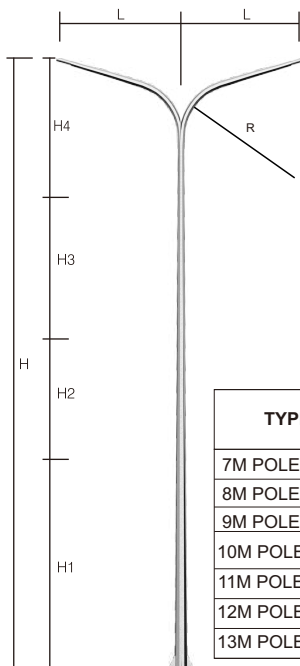

TYPE	HEIGHT (mm)					# PIPE (inches)				BASE PLATE (mm)			ANCHOR (mm)		
	H	h1	h2	h3	h4	h1	h2	h3	h4	a	b	c	d	e	f
7M POLE R S/D	7000	3000	-	2500	1500	4	-	3	2	300	200	12	500	100	16
8M POLE R S/D	8000	3000	-	3500	1500	4	-	3	2						
9M POLE R S/D	9000	3000	2850	1650	1500	5	4	3	2	400	300	16	600	150	19
10M POLE R S/D	10000	3000	2850	2650	1500	5	4	3	2						
11M POLE R S/D	11000	3000	2850	3650	1500	5	4	3	2						
12M POLE R S/D	12000	6000	2850	1650	1500	5	4	3	2				600	150	22
13M POLE R S/D	13000	6000	2850	2650	1500	5	4	3	2						



INDOOR LED STRIP

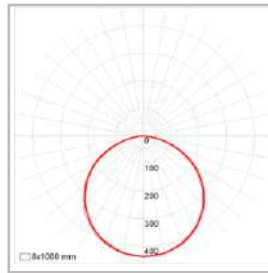
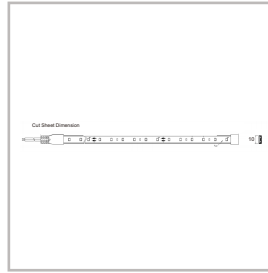
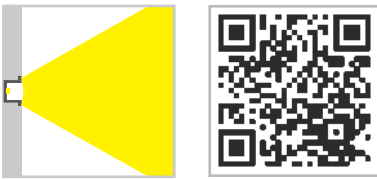

LIGHT SOURCE

LED Source	: LED
CCT	: 2700K, 3000K, 4000K, 6500K, RGBW
Input Voltage	: DC24V
Wattage/roll	: 18W~100W
Beam Angle	: 120°
CRI	: 80Ra
Lumen/roll	: 1500-10.000lm
Efficacy	: 100lm/W
Dimming Type	: Dimmable/ Non-Dimmable

HOUSING

Dimension	: 5000 x 9mm
Accessories	: U-channel Aluminium Profil
Material	: Aluminium
Orientation	: Fixed
IP Rating	: IP20

OUTDOOR LED STRIP

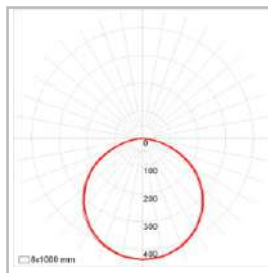
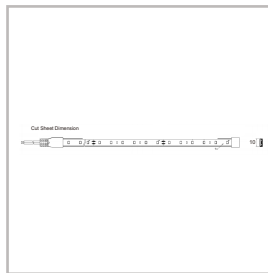
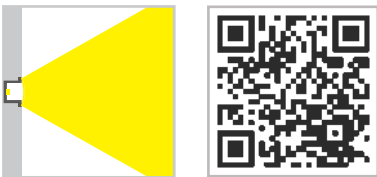

LIGHT SOURCE

LED Source	: LED
CCT	: 2700K, 3000K, 4000K, 6500K, RGBW
Input Voltage	: DC24V
Wattage/roll	: 18W~100W
Beam Angle	: 120°
CRI	: 80Ra
Lumen/roll	: 1500-10.000lm
Efficacy	: 100lm/W
Dimming Type	: Dimmable/ Non-Dimmable

HOUSING

Dimension	: 5000 x 9mm
Accessories	: U-channel Aluminium Profil
Material	: Double Layer 20z
Orientation	: Fixed
IP Rating	: IP65





UPN VETERAN JAWA TIMUR

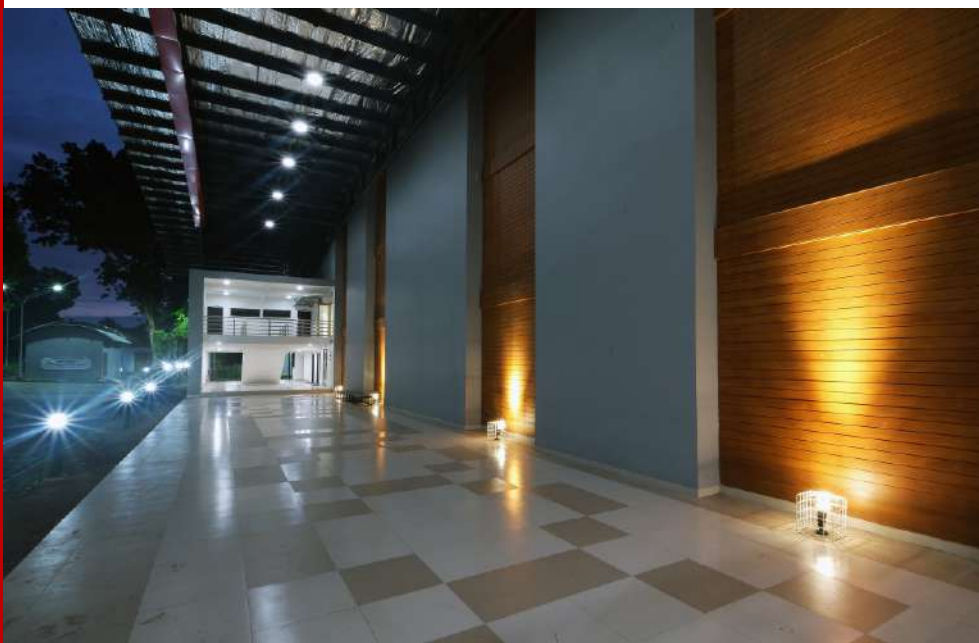





Gedung Sarinah Thamrin, Jakarta



Gedung Sarinah Thamrin, Jakarta



Gedung Telkom Cikarang, Jawa Barat



Sirkuit Mandalika, Nusa Tenggara Barat



Waduk Brigif, Jakarta



Mandiri University, Jakarta

