



VOKSEL KABEL



BUILDING WIRE





Building Wire

Contents

FRC.....	1
N2XY.....	5
NA2XY.....	9
NYAF	13
NAYY.....	14
NYA	18
NYB(AL)Y.....	19
NYBY.....	20
NYFGBY.....	23
NYR(AL)Y	30
NYRGBY	31
NYM.....	37
NY Y	41
BCC - HH.....	47
BCC - H.....	48

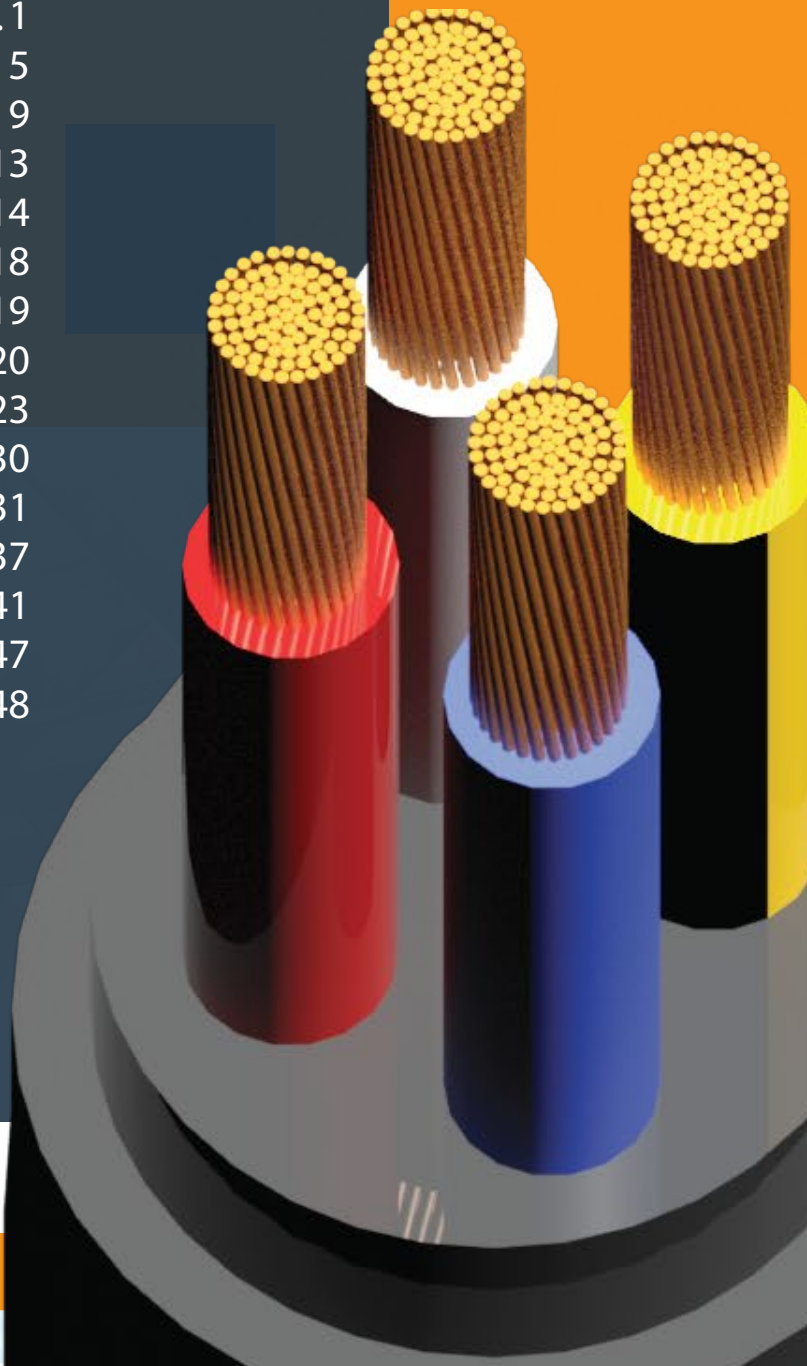



VOKSEL KABEL

Fire Resistance Cables

FRC 1 x (1.5 - 800) mm² 0.6/1 kV

Cu/MGT/XLPE/LSFH

(Copper Conductor, Mica Glass Tape, XLPE Insulated, Low Smoke Free Halogen Sheathed)
Standard Specification : SNI 60502-1, SS 299, BS 6387, IEC 60502-1, IEC 60331

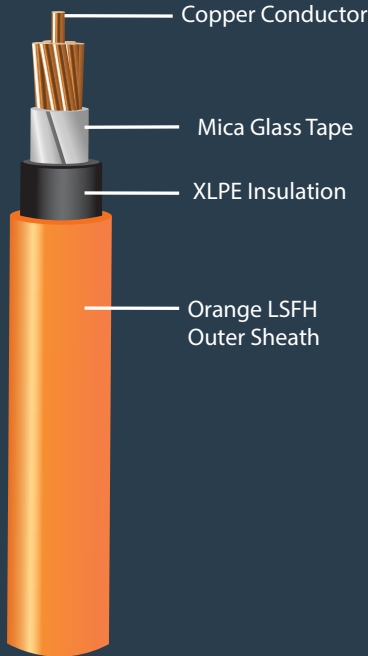

Special Features on Request

- UV Resistance
- Flame Retardant Cat A, B, C
- Flame Retardant Non Category
- Heat Resistance
- Anti Termite
- Anti Rodent

Note

Conductor Shape

1.5 - 10 mm² supplied in solid (re) or non compacted circular stranded (rm) conductor shape
16 mm² supplied in non compacted circular stranded (rm) conductor shape
25 - 800 mm² supplied in non compacted circular stranded (rm) or compacted circular stranded (cm) conductor shape

Standard Packing

1.5 - 10 mm² supplied in coil @100 meters
16 - 400 mm² supplied in wooden drum @1000 meters
500 - 800 mm² supplied in wooden drum on available length
Length Tolerance per drum ± 2%

Application:

For wiring of fire resistance safety circuits, such as fire alarm system, emergency lighting and power, public address and emergency voice communication systems in highrise building, control and instrumentation services in industrial, commercial and residential complexes.

Construction Data

Nominal Cross Section Area	Overall Diameter	Cable Weight
	approx	approx
mm ²	mm	kg/km
1.5	6.5	54
2.5	7.0	67
4	7.5	85
6	8.0	108
10	9.0	152
16	10.0	215
25	11.5	315
35	12.5	410
50	14.5	540
70	16.5	750
95	18.5	1,010
120	20.5	1,265
150	22.5	1,540
185	25.0	1,900
240	28.0	2,470
300	31.0	3,075
400	34.5	3,910
500	38.5	4,950
630	43.0	6,445
800	48.5	8,165

Electrical Data

Nom Cross Section Area mm ²	Conductor		inductance (mH/km)	Current - Carrying Capacity at 30°C		Short Circuit current at 1 second Max. (kA)
	DC Resistance at 20°C Max (Ω/km)	AC Resistance at 90°C Max (Ω/km)		in Air Max. (A)	in Ground Max. (A)	
1.5	12.1	15.429	0.488	35	43	0.21
2.5	7.41	9.449	0.445	43	58	0.36
4	4.61	5.787	0.421	57	76	0.57
6	3.08	3.927	0.395	72	95	0.86
10	1.83	2.334	0.367	98	128	1.43
16	1.15	1.466	0.341	132	169	2.29
25	0.727	0.927	0.324	187	220	3.58
35	0.524	0.668	0.308	217	265	5.01
50	0.387	0.494	0.295	263	316	7.15
70	0.268	0.342	0.284	331	385	10.02
95	0.193	0.347	0.274	408	465	13.59
120	0.153	0.196	0.268	474	531	17.17
150	0.124	0.160	0.267	550	597	21.46
185	0.0991	0.128	0.264	633	680	26.47
240	0.0754	0.099	0.257	750	790	34.34
300	0.0601	0.080	0.256	871	901	42.93
400	0.0470	0.061	0.252	1019	1032	57.23
500	0.0366	0.052	0.250	1188	1180	71.54
630	0.0283	0.043	0.247	1241	1233	90.14
800	0.0221	0.036	0.245	1295	1287	114.47

* Further information about rating factor for certain cable arrangement can be found on supplementary technical information

Fire Resistance Cables

FRC 2 x (1.5 - 300) mm² 0.6/1 kV

Cu/ MGT/ XLPE/ LSFH

(Copper Conductor, Mica Glass Tape, XLPE Insulated, Low Smoke Free Halogen Sheathed)
Standard Specification : SNI 60502-1, SS 299, BS 6387, IEC 60502-1, IEC 60331



Construction Data

Nominal Cross Section Area	Overall Diameter	Cable Weight
	approx	approx
mm ²	mm	kg/km
1.5	11.0	120
2.5	11.5	145
4	13.0	185
6	14.0	235
10	15.5	325
16	18.0	455
25	24.0	950
35	26.5	1,200
50	29.5	1,580
70	34.0	2,200
95	39.0	2,890
120	43.0	3,580
150	47.5	4,390
185	52.5	5,400
240	59.0	7,000
300	64.5	8,600

Special Features on Request

- UV Resistance
- Flame Retardant Cat A, B, C
- Flame Retardant Non Category
- Heat Resistance
- Anti Termite
- Anti Rodent

Note

Conductor Shape

1.5 - 10 mm² supplied in solid (re) or non compacted circular stranded (rm) conductor shape

16 mm² supplied in non compacted circular stranded (rm) conductor shape

25 - 300 mm² supplied in non compacted circular stranded (rm) or compacted circular stranded (cm) conductor shape

Standard Packing

1.5 - 120 mm² supplied in wooden drum @1000 meters

150- 300 mm² supplied in wooden drum on available length
Length Tolerance per drum ± 2%

Copper Conductor

Mica Glass Tape

XLPE Insulation

LSFH Inner Sheath

Orange LSFH

Outer Sheath

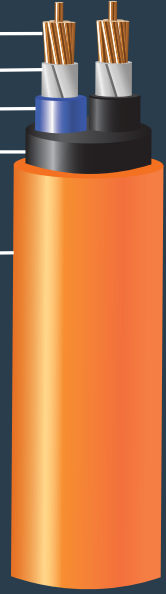

Application:

For wiring of fire resistance safety circuits, such as fire alarm system, emergency lighting and power, public address and emergency voice communication systems in highrise building, control and instrumentation services in industrial, commercial and residential complexes.

Electrical Data

Nom Cross Section Area mm ²	Conductor		inductance (mH/km)	Current - Carrying Capacity at 30°C		Short Circuit current at 1 second Max. (kA)
	DC Resistance at 20°C Max (Ω/km)	AC Resistance at 90°C Max (Ω/km)		in Air Max. (A)	in Ground Max. (A)	
1.5	12.1	15.429	0.367	27	33	0.21
2.5	7.41	9.449	0.342	36	44	0.36
4	4.61	5.787	0.319	48	58	0.57
6	3.08	3.927	0.303	61	72	0.86
10	1.83	2.334	0.284	83	97	1.43
16	1.15	1.466	0.269	113	128	2.29
25	0.727	0.927	0.267	150	167	3.58
35	0.524	0.668	0.259	186	201	5.01
50	0.387	0.494	0.246	226	239	7.15
70	0.268	0.342	0.241	290	295	10.02
95	0.193	0.347	0.235	353	355	13.59
120	0.153	0.196	0.232	413	404	17.17
150	0.124	0.160	0.232	468	458	21.46
185	0.0991	0.128	0.231	540	516	26.47
240	0.0754	0.099	0.227	590	600	34.34
300	0.0601	0.080	0.225	745	695	42.93

* Further information about rating factor for certain cable arrangement can be found on supplementary technical information

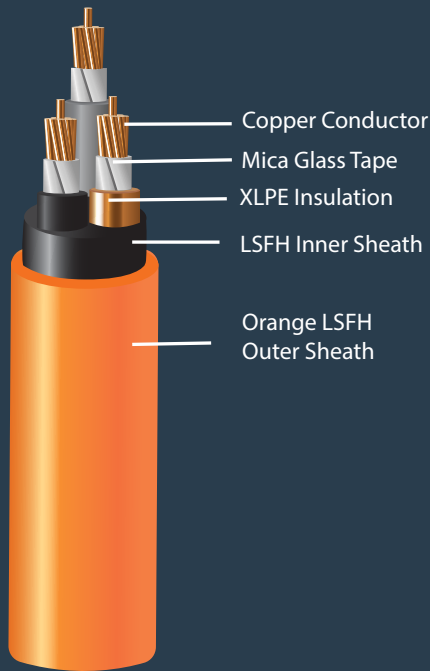

Special Features on Request

- UV Resistance
- Flame Retardante Cat A, B, C
- Flame Retardant Non Category
- Heat Resistance
- Anti Termite
- Anti Rodent

Note

Conductor Shape

1.5 - 10 mm² supplied in solid (re) or non compacted circular stranded (rm) conductor shape
16 mm² supplied in non compacted circular stranded (rm) conductor shape
25 - 300 mm² supplied in non compacted circular stranded (rm) or compacted circular stranded (cm) conductor shape

Standard Packing

1.5 - 95 mm² supplied in wooden drum @1000 meters
120 - 300 mm² supplied in wooden drum on available length
Length Tolerance per drum ± 2%

Construction Data

Nominal Cross Section Area	Overall Diameter	Cable Weight
	approx	approx
mm ²	mm	kg/km
1.5	11.5	145
2.5	12.5	183
4	13.5	238
6	14.5	305
10	16.5	438
16	19.0	630
25	25.5	1,180
35	28.0	1,520
50	31.5	2,020
70	36.5	2,820
95	41.5	3,720
120	46.5	4,690
150	50.5	5,690
185	56.5	7,070
240	63.0	9,100
300	66.5	11,235

Application:

For wiring of fire resistance safety circuits, such as fire alarm system, emergency lighting and power, public address and emergency voice communication systems in highrise building, control and instrumentation services in industrial, commercial and residential complexes.

Electrical Data

Nom Cross Section Area mm ²	Conductor		inductance (mH/km)	Current - Carrying Capacity at 30°C		Short Circuit current at 1 second Max. (kA)
	DC Resistance at 20°C Max (Ω/km)	AC Resistance at 90°C Max (Ω/km)		in Air Max. (A)	in Ground Max. (A)	
1.5	12.1	15.429	0.367	23	29	0.22
2.5	7.41	9.449	0.342	32	38	0.37
4	4.61	5.787	0.319	41	49	0.59
6	3.08	3.927	0.303	52	60	0.89
10	1.83	2.334	0.248	71	97	1.49
16	1.15	1.466	0.269	96	108	2.38
25	0.727	0.927	0.267	130	141	3.71
35	0.524	0.668	0.259	159	170	5.20
50	0.387	0.494	0.246	193	201	7.43
70	0.268	0.342	0.241	245	249	10.40
95	0.193	0.347	0.235	302	299	14.11
120	0.153	0.196	0.232	349	340	17.83
150	0.124	0.160	0.232	400	381	22.29
185	0.0991	0.128	0.231	464	434	27.49
240	0.0754	0.099	0.227	552	506	35.66
300	0.0601	0.080	0.225	640	586	44.57

* Further information about rating factor for certain cable arrangement can be found on supplementary technical information

Fire Resistance Cables

FRC 4 x (1.5 - 300) mm² 0.6/1 kV

Cu/ MGT/ XLPE/ LSFH

(Copper Conductor, Mica Glass Tape, XLPE Insulated, Low Smoke Free Halogen Sheathed)
Standard Specification : SNI 60502-1, SS 299, BS 6387, IEC 60502-1, IEC 60331



Construction Data

Nominal Cross Section Area	Overall Diameter	Cable Weight
	approx	approx
mm ²	mm	kg/km
1.5	12.5	174
2.5	13.5	221
4	14.5	294
6	16.0	382
10	18.0	555
16	20.5	800
25	27.5	1,470
35	30.5	1,915
50	35.0	2,580
70	40.0	3,560
95	46.5	4,780
120	51.0	5,970
150	56.5	7,315
185	62.5	9,020
240	69.5	11,640
300	76.5	14,480

Special Features on Request

- UV Resistance
- Flame Retardant Cat A, B, C
- Flame Retardant Non Category
- Heat Resistance
- Anti Termite
- Anti Rodent

Note

Conductor Shape

1.5 - 10 mm² supplied in solid (re) or non compacted circular stranded (rm) conductor shape

16 mm² supplied in non compacted circular stranded (rm) conductor shape

25 - 300 mm² supplied in non compacted circular stranded (rm) or compacted circular stranded (cm) conductor shape

Standard Packing

1.5 - 70 mm² supplied in wooden drum @1000 meters

95 - 300 mm² supplied in wooden drum on available length
Length Tolerance per drum ± 2%

Copper Conductor

Mica Glass Tape

XLPE Insulation

LSFH Inner Sheath

Orange LSFH

Outer Sheath

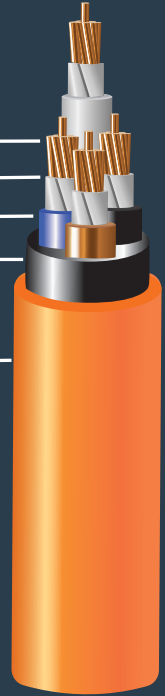

Application:

For wiring of fire resistance safety circuits, such as fire alarm system, emergency lighting and power, public address and emergency voice communication systems in highrise building, control and instrumentation services in industrial, commercial and residential complexes.

Electrical Data

Nom Cross Section Area mm ²	Conductor		inductance (mH/km)	Current - Carrying Capacity at 30°C		Short Circuit current at 1 second Max. (kA)
	DC Resistance at 20°C Max (Ω/km)	AC Resistance at 90°C Max (Ω/km)		in Air Max. (A)	in Ground Max. (A)	
1.5	12.1	15.429	0.367	23	29	0.21
2.5	7.41	9.449	0.342	32	38	0.36
4	4.61	5.787	0.319	41	49	0.57
6	3.08	3.927	0.303	52	60	0.86
10	1.83	2.334	0.284	71	97	1.43
16	1.15	1.466	0.269	96	108	2.29
25	0.727	0.927	0.267	130	141	3.58
35	0.524	0.668	0.259	159	170	5.01
50	0.387	0.494	0.246	193	201	7.15
70	0.268	0.342	0.241	245	249	10.02
95	0.193	0.347	0.235	302	299	13.59
120	0.153	0.196	0.232	349	340	17.17
150	0.124	0.160	0.232	400	381	21.46
185	0.0991	0.128	0.231	464	434	26.47
240	0.0754	0.099	0.227	552	506	34.34
300	0.0601	0.080	0.225	640	586	42.93

* Further information about rating factor for certain cable arrangement can be found on supplementary technical information

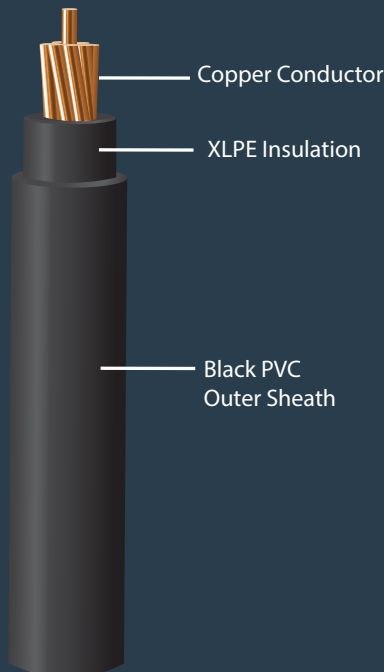

Special Features on Request

- UV Resistance
- Retardant Flame Cat A, B, C
- Retardant Flame Non Category
- Heat Resistance
- Anti Termite
- Anti Rodent
- Low Smoke Zero Halogen

Note

Conductor Shape

1.5 - 10 mm² supplied in solid (re) or non compacted circular stranded (rm) conductor shape

16 mm² supplied in non compacted circular stranded (rm) conductor shape

25 - 500 mm² supplied in non compacted circular stranded (rm) or compacted circular stranded (cm) conductor shape

Standard Packing

1.5 - 10 mm² supplied in coil @100 meters

16 - 300 mm² supplied in wooden drum

@1000 meters

400 - 500 mm² supplied in wooden drum on available length

Length Tolerance per drum ± 2%

Application:

Power cable: Indoors, cable trunking, outdoors and buried in the ground, for power stations, industry and switchgear as well as for urban supply networks. if mechanical damage is unlikely.

Construction Data

Nominal Cross Section Area	Overall Diameter	Cable Weight
	approx	approx
mm ²	mm	kg/km
1.5	6.0	47
2.5	6.5	59
4	7.0	77
6	7.5	99
10	8.5	145
16	9.5	205
25	11.0	305
35	12.0	405
50	14.0	530
70	16.0	740
95	18.0	1,000
120	20.0	1,250
150	22.0	1,525
185	24.5	1,890
240	27.5	2,460
300	30.0	3,050
400	33.5	3,900
500	37.5	4,940

Electrical Data

Nom Cross Section Area mm ²	Conductor		inductance (mH/km)	Current - Carrying Capacity at 30°C		Short Circuit current at 1 second Max. (kA)
	DC Resistance at 20°C Max (Ω/km)	AC Resistance at 90°C Max (Ω/km)		in Air Max. (A)	in Ground Max. (A)	
1.5	12.1	15.429	0.472	35	43	0.21
2.5	7.41	9.449	0.440	43	58	0.36
4	4.61	5.787	0.407	57	76	0.57
6	3.08	3.927	0.382	72	95	0.86
10	1.83	2.334	0.335	98	128	1.43
16	1.15	1.466	0.330	132	169	2.29
25	0.727	0.927	0.315	187	220	3.58
35	0.524	0.668	0.300	217	265	5.01
50	0.387	0.494	0.288	263	316	7.15
70	0.268	0.342	0.278	331	385	10.02
95	0.193	0.347	0.269	408	465	13.59
120	0.153	0.196	0.263	474	531	17.17
150	0.124	0.160	0.262	550	597	21.46
185	0.0991	0.128	0.260	633	680	26.47
240	0.0754	0.099	0.254	750	790	34.34
300	0.0601	0.080	0.249	871	901	42.93
400	0.0470	0.064	0.247	1019	1032	57.23
500	0.0366	0.052	0.244	1188	1180	71.54

* Further information about rating factor for certain cable arrangement can be found on supplementary technical information

N2XY 2 x (1.5 - 300) mm² 0.6/1 kV Cu/XLPE/PVC

(Copper Conductor, XLPE Insulated, PVC Sheathed)
Standard Specification : SPLN 43 - 6, IEC 60502-1, SNI 60502-1



Construction Data

Nominal Cross Section Area	Overall Diameter	Cable Weight
	approx	approx
mm ²	mm	kg/km
1.5	12.0	185
2.5	12.5	220
4	13.5	275
6	15.0	340
10	16.5	465
16	18.5	640
25	23.0	930
35	25.5	1,195
50	28.5	1,570
70	33.0	2,200
95	38.0	2,900
120	42.0	3,610
150	46.5	4,430
185	51.5	5,485
240	58.0	7,120
300	63.5	8,765

Special Features on Request

- UV Resistance
- Retardant Flame Cat A, B, C
- Retardant Flame Non Category
- Heat Resistance
- Anti Termite
- Anti Rodent
- Low Smoke Zero Halogen

Note

Conductor Shape

1.5 - 10 mm² supplied in solid (re) or non compacted circular stranded (rm) conductor shape

16 sqmm supplied in non compacted circular stranded (rm) conductor shape

25 - 300 mm² supplied in non compacted circular stranded (rm) or compacted circular stranded (cm) conductor shape

Standard Packing

1.5 - 150 mm² supplied in coil @100 meters

185 - 300 mm² supplied in wooden drum @1000 meters

Length Tolerance per drum ± 2%

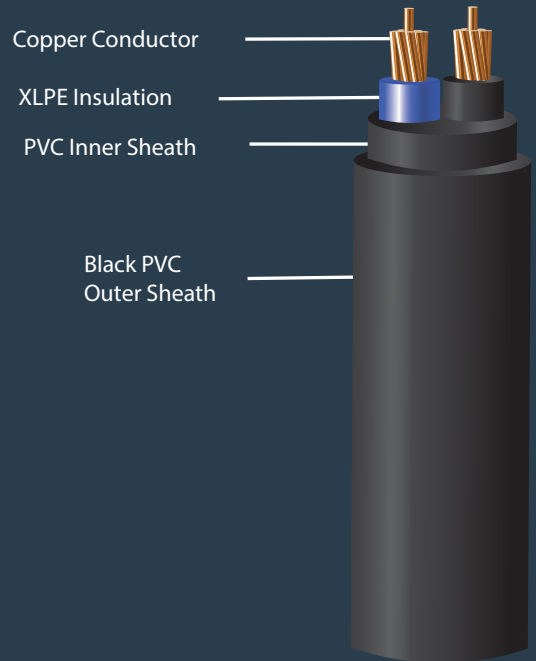

Application:

Power cable: Indoors, cable trunking, outdoors and buried in the ground, for power stations, industry and switchgear as well as for urban supply networks, if mechanical damage is unlikely.

Electrical Data

Nom Cross Section Area mm ²	Conductor		inductance (mH/km)	Current - Carrying Capacity at 30°C		Short Circuit current at 1 second Max. (kA)
	DC Resistance at 20°C Max (Ω/km)	AC Resistance at 90°C Max (Ω/km)		in Air Max. (A)	in Ground Max. (A)	
1.5	12.1	15.429	0.315	27	33	0.21
2.5	7.41	9.449	0.313	36	44	0.36
4	4.61	5.787	0.294	48	58	0.57
6	3.08	3.927	0.281	61	72	0.86
10	1.83	2.334	0.266	83	97	1.43
16	1.15	1.466	0.254	113	128	2.29
25	0.727	0.927	0.255	150	167	3.58
35	0.524	0.668	0.248	186	201	5.01
50	0.387	0.494	0.237	226	239	7.15
70	0.268	0.342	0.233	290	295	10.02
95	0.193	0.347	0.228	353	355	13.59
120	0.153	0.196	0.224	413	404	17.17
150	0.124	0.160	0.226	468	458	21.46
185	0.0991	0.128	0.226	540	516	26.47
240	0.0754	0.099	0.223	590	600	34.34
300	0.0601	0.080	0.221	745	695	42.93

* Further information about rating factor for certain cable arrangement can be found on supplementary technical information

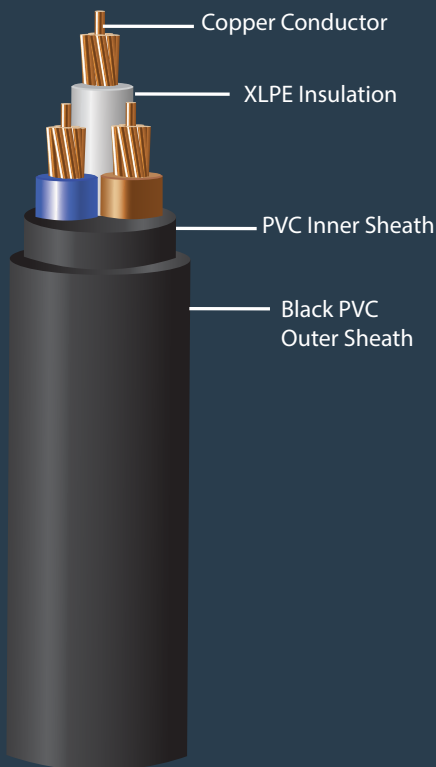

Special Features on Request

- UV Resistance
- Retardant Flame Cat A, B, C
- Retardant Flame Non Category
- Heat Resistance
- Anti Termite
- Anti Rodent
- Low Smoke Zero Halogen

Note

Conductor Shape

1.5 - 10 mm² supplied in solid (re) or non compacted circular stranded (rm) conductor shape
16 mm² supplied in non compacted circular stranded (rm) conductor shape
25 - 300 mm² supplied in non compacted circular stranded (rm) or compacted circular stranded (cm) conductor shape

Standard Packing

1.5 - 120 mm² supplied in coil @100 meters
150 - 300 mm² supplied in wooden drum @1000 meters
Length Tolerance per drum ± 2%

Construction Data

Nominal Cross Section Area	Overall Diameter	Cable Weight
	approx	approx
mm ²	mm	kg/km
1.5	12.5	205
2.5	13.0	250
4	14.5	315
6	15.5	400
10	17.5	560
16	19.5	790
25	24.5	1,160
35	26.5	1,500
50	30.5	1,990
70	35.5	2,800
95	40.5	3,720
120	45.0	4,700
150	49.5	5,720
185	55.0	7,070
240	62.0	9,200
300	67.5	11,370

Application:

Power cable: Indoors, cable trunking, outdoors and buried in the ground, for power stations, industry and switchgear as well as for urban supply networks. if mechanical damage is unlikely.

Electrical Data

Nom Cross Section Area mm ²	Conductor		inductance (mH/km)	Current - Carrying Capacity at 30°C		Short Circuit current at 1 second Max. (kA)
	DC Resistance at 20°C Max (Ω/km)	AC Resistance at 90°C Max (Ω/km)		in Air Max. (A)	in Ground Max. (A)	
1.5	12.1	15.429	0.335	23	29	0.21
2.5	7.41	9.449	0.313	32	38	0.36
4	4.61	5.787	0.294	41	49	0.57
6	3.08	3.927	0.281	52	60	0.86
10	1.83	2.334	0.266	71	97	1.43
16	1.15	1.467	0.255	96	108	2.29
25	0.727	0.927	0.255	130	141	3.58
35	0.524	0.668	0.248	159	170	5.01
50	0.387	0.494	0.237	193	201	7.15
70	0.268	0.342	0.233	245	249	10.02
95	0.193	0.347	0.228	302	299	13.59
120	0.153	0.196	0.224	349	340	17.17
150	0.124	0.160	0.226	400	381	21.46
185	0.0991	0.128	0.226	464	434	26.47
240	0.0754	0.099	0.223	552	506	34.34
300	0.0601	0.080	0.221	640	585	42.93

* Further information about rating factor for certain cable arrangement can be found on supplementary technical information

N2XY 4 x (1.5 - 300) mm² 0.6/1 kV Cu/XLPE/PVC

(Copper Conductor, XLPE Insulated, PVC Sheathed)
Standard Specification : SPLN 43 - 6, IEC 60502-1, SNI 60502-1

Construction Data

Nominal Cross Section Area	Overall Diameter	Cable Weight
	approx	approx
mm ²	mm	kg/km
1.5	13.0	230
2.5	14.0	290
4	15.5	375
6	17.0	480
10	19.0	680
16	21.5	970
25	26.5	1,440
35	28.5	1,890
50	30.5	2,220
70	35.5	3,140
95	41.5	4,220
120	45.0	5,300
150	50.5	6,475
185	56.0	8,035
240	61.5	10,370
300	67.0	12,840

Special Features on Request

- UV Resistance
- Retardant Flame Cat A, B, C
- Retardant Flame Non Category
- Heat Resistance
- Anti Termite
- Anti Rodent
- Low Smoke Zero Halogen

Note

Conductor Shape

1.5 - 10 mm² supplied in solid (re) or non compacted circular stranded (rm) conductor shape
16 sqmm supplied in non compacted circular stranded (rm) conductor shape
25 - 35 mm² supplied in non compacted circular stranded (rm) or compacted circular stranded (cm) conductor shape
50 - 400 mm² supplied in non compacted circular stranded (rm) or compacted circular stranded (cm) or sector shaped stranded (sm) conductor

Standard Packing

15 - 70 mm² supplied in wooden drum @1000 meters
95 - 300 mm² supplied in wooden drum @1000 meters on available length
Length Tolerance per drum ± 2%



VOKSEL KABEL

Copper Conductor

XLPE Insulation

PVC Inner Sheath

Black PVC
Outer Sheath

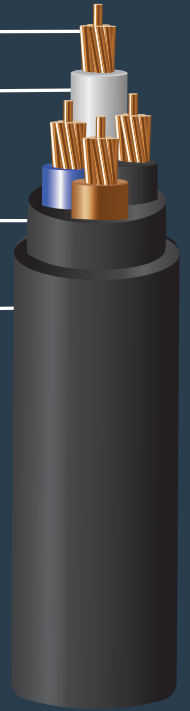

Application:

Power cable: Indoors, cable trunking, outdoors and buried in the ground, for power stations, industry and switchgear as well as for urban supply networks, if mechanical damage is unlikely.

Electrical Data

Nom Cross Section Area mm ²	Conductor		inductance (mH/km)	Current - Carrying Capacity at 30°C		Short Circuit current at 1 second Max. (kA)
	DC Resistance at 20°C Max (Ω/km)	AC Resistance at 90°C Max (Ω/km)		in Air Max. (A)	in Ground Max. (A)	
1.5	12.1	15.429	0.335	23	29	0.21
2.5	7.41	9.449	0.313	32	38	0.36
4	4.61	5.787	0.294	41	49	0.57
6	3.08	3.927	0.281	52	60	0.86
10	1.83	2.334	0.266	71	97	1.43
16	1.15	1.467	0.254	96	108	2.29
25	0.727	0.927	0.255	130	141	3.58
35	0.524	0.668	0.248	159	170	5.01
50	0.387	0.494	0.242	193	201	7.15
70	0.268	0.342	0.238	245	249	10.02
95	0.193	0.347	0.232	302	299	13.59
120	0.153	0.196	0.229	349	340	17.17
150	0.124	0.160	0.230	400	381	21.46
185	0.0991	0.128	0.231	464	434	26.47
240	0.0754	0.099	0.223	552	506	34.34
300	0.0601	0.080	0.226	640	585	42.93

* Further information about rating factor for certain cable arrangement can be found on supplementary technical information



VOKSEL KABEL

NA2XY 1 x (10 - 800) mm² 0.6/1 kV AL/XLPE/PVC

(Aluminium Conductor, XLPE Insulated, PVC Sheathed)
Standard Specification : SPLN 43-6, IEC 60502-1, SNI 60502-1

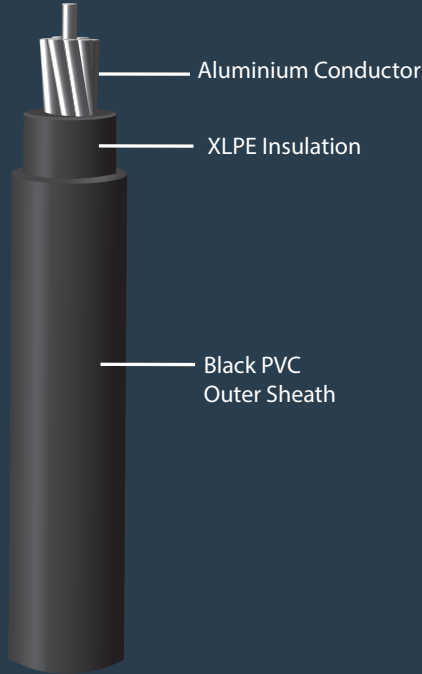

Special Features on Request

- Oil Resistance
- UV Resistance
- Retardant Flame Cat A, B, C
- Retardant Flame Non Category
- Heat Resistance
- Anti Termite
- Anti Rodent
- Low Smoke Zero Halogen

Note

Conductor Shape

10 mm² supplied in solid (re) or non compacted circular stranded (rm) conductor shape

16 - 800 mm² supplied in non compacted circular stranded (rm) or compacted circular stranded (cm) conductor shape

Standard Packing

10 - 800 mm² supplied in wooden drum @1000 meters
Length Tolerance per drum ± 2%

Construction Data

Nominal Cross Section Area	Overall Diameter	Cable Weight
	approx	approx
mm ²	mm	kg/km
10	8.5	83
16	9.5	111
25	11.5	157
35	12.5	196
50	14.0	260
70	16.0	345
95	18.0	445
120	20.0	545
150	22.0	660
185	24.5	815
240	28.0	1,030
300	30.5	1,265
400	34.5	1,625
500	38.0	1,970
630	43.0	2,520
800	47.5	3,100

Application:

Power cable: Indoors, cable trunking, outdoors and buried in the ground, for power stations, industry and switchgear as well as for urban supply networks. if mechanical damage is unlikely.

Electrical Data

Nom Cross Section Area mm ²	Conductor		inductance (mH/km)	Current - Carrying Capacity at 30°C		Short Circuit current at 1 second Max. (kA)
	DC Resistance at 20°C Max (Ω/km)	AC Resistance at 90°C Max (Ω/km)		in Air Max. (A)	in Ground Max. (A)	
10	3.08	3.949	0.351	72	95	0.94
16	1.91	2.449	0.326	102	131	1.51
25	1.20	1.539	0.319	137	170	2.36
35	0.868	1.113	0.303	168	205	3.31
50	0.641	0.822	0.279	204	242	4.72
70	0.443	0.568	0.271	257	301	6.61
95	0.320	0.411	0.265	316	360	8.98
120	0.253	0.325	0.259	368	421	11.34
150	0.206	0.265	0.258	421	463	14.17
185	0.164	0.212	0.257	488	525	17.48
240	0.125	0.162	0.254	583	615	22.68
300	0.100	0.130	0.249	675	700	28.35
400	0.0778	0.103	0.246	790	800	37.79
500	0.0605	0.081	0.245	921	915	47.24
630	0.0469	0.065	0.243	942	936	59.52
800	0.0367	0.053	0.240	1074	1068	75.59

* Further information about rating factor for certain cable arrangement can be found on supplementary technical information

NA2XY 2 x (10- 300) mm² 0.6/1 kV AL/XLPE/PVC

(Aluminium Conductor, XLPE Insulated, PVC Sheathed)
Standard Specification : SPLN 43-6, IEC 60502-1, SNI 60502-1



Construction Data

Nominal Cross Section Area	Overall Diameter	Cable Weight
	approx	approx
mm ²	mm	kg/km
10	17.0	355
16	19.0	460
25	22.5	650
35	25.0	810
50	29.5	1065
70	33.5	1,440
95	38.5	1,810
120	42.5	2,200
150	47.5	2,730
185	52.0	3,360
240	58.5	4,300
300	64.0	5,220

Special Features on Request

- Oil Resistance
- UV Resistance
- Retardant Flame Cat A, B, C
- Retardant Flame Non Category
- Heat Resistance
- Anti Termite
- Anti Rodent
- Low Smoke Zero Halogen

Note

Conductor Shape

10 mm² supplied in solid (re) or non compacted circular stranded (rm) conductor shape
16 - 300 mm² supplied in non compacted circular stranded (rm) or compacted circular stranded (cm)

Standard Packing

10 - 185 mm² supplied in wooden drum @1000 meters
240 - 300 mm² supplied in wooden drum on available length
Length Tolerance per drum ± 2%

Aluminium Conductor

XLPE Insulation

PVC Inner Sheath

Black PVC Outer Sheath



Application:

Power cable: Indoors, cable trunking, outdoors and buried in the ground, for power stations, industry and switchgear as well as for urban supply networks. If mechanical damage is unlikely.

Electrical Data

Nom Cross Section Area mm ²	Conductor		inductance (mH/km)	Current - Carrying Capacity at 30°C		Short Circuit current at 1 second Max. (kA)
	DC Resistance at 20°C Max (Ω/km)	AC Resistance at 90°C Max (Ω/km)		in Air Max. (A)	in Ground Max. (A)	
10	3.08	3.949	0.264	61	72	0.94
16	1.91	2.449	0.253	88	99	1.51
25	1.20	1.539	0.254	119	130	2.36
35	0.868	1.113	0.247	145	157	3.31
50	0.641	0.822	0.235	175	185	4.72
70	0.443	0.568	0.232	220	229	6.61
95	0.320	0.411	0.227	272	276	8.98
120	0.253	0.325	0.224	317	320	11.34
150	0.206	0.265	0.225	362	351	14.17
185	0.164	0.212	0.226	420	400	17.48
240	0.125	0.162	0.222	297	467	22.68
300	0.100	0.130	0.220	577	532	28.35

* Further information about rating factor for certain cable arrangement can be found on supplementary technical information

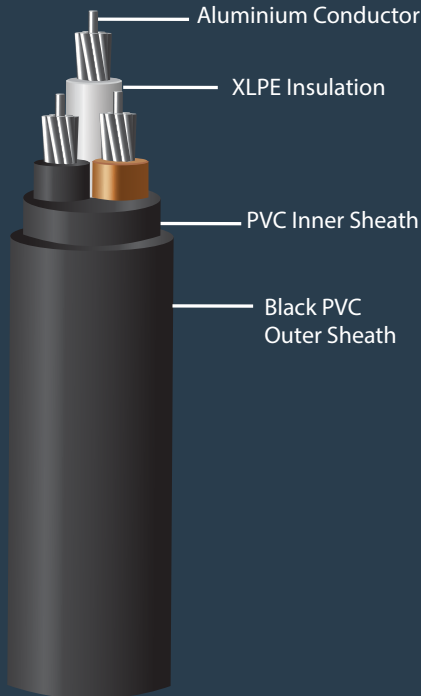

Special Features on Request

- Oil Resistance
- UV Resistance
- Retardant Flame Cat A, B, C
- Retardant Flame Non Category
- Heat Resistance
- Anti Termite
- Anti Rodent
- Low Smoke Zero Halogen

Note

Conductor Shape

10 mm² supplied in solid (re) or non compacted circular stranded (rm) conductor shape

16 - 300 mm² supplied in non compacted circular stranded (rm) or compacted circular stranded (cm) conductor shape

Standard Packing

10 - 185 mm² supplied in wooden drum @1000 meters

240 - 300 mm² supplied in wooden drum on available length

Length Tolerance per drum ± 2%

Construction Data

Nominal Cross Section Area	Overall Diameter	Cable Weight
	approx	approx
mm ²	mm	kg/km
10	17.5	390
16	20.0	520
25	24.5	730
35	27.0	910
50	31.0	1,205
70	36.0	1,645
95	41.0	2,070
120	45.5	2,570
150	50.0	3,120
185	56.0	3,910
240	62.5	4,925
300	68.5	5,995

Application:

Power cable: Indoors, cable trunking, outdoors and buried in the ground, for power stations, industry and switchgear as well as for urban supply networks. if mechanical damage is unlikely.

Electrical Data

Nom Cross Section Area mm ²	Conductor		inductance (mH/km)	Current - Carrying Capacity at 30°C		Short Circuit current at 1 second Max. (kA)
	DC Resistance at 20°C Max (Ω/km)	AC Resistance at 90°C Max (Ω/km)		in Air Max. (A)	in Ground Max. (A)	
10	3.08	3.949	0.264	52	60	0.94
16	1.91	2.449	0.253	75	84	1.51
25	1.20	1.539	0.254	100	110	2.36
35	0.868	1.113	0.247	123	132	3.31
50	0.641	0.822	0.235	149	156	4.72
70	0.443	0.568	0.232	189	193	6.61
95	0.320	0.411	0.227	233	232	8.98
120	0.253	0.325	0.224	271	268	11.34
150	0.206	0.265	0.225	310	296	14.17
185	0.164	0.212	0.226	359	336	17.48
240	0.125	0.162	0.222	429	429	22.68
300	0.100	0.130	0.220	496	447	28.35

* Further information about rating factor for certain cable arrangement can be found on supplementary technical information

NA2XY 4 x (10- 300) mm² 0.6/1 kV AL/XLPE/PVC

(Aluminium Conductor, XLPE Insulated, PVC Sheathed)
Standard Specification : SPLN 43-6, IEC 60502-1, SNI 60502-1

Construction Data

Nominal Cross Section Area	Overall Diameter	Cable Weight
	approx	approx
mm ²	mm	kg/km
10	19.0	455
16	21.5	605
25	27.0	870
35	29.5	1,100
50	30.5	1,125
70	35.5	1,530
95	41.5	1,960
120	45.0	2,395
150	50.5	2,940
185	56.0	3,640
240	61.5	4,520
300	67.0	5,470

Special Features on Request

- Oil Resistance
- UV Resistance
- Retardant Flame Cat A, B, C
- Retardant Flame Non Category
- Heat Resistance
- Anti Termite
- Anti Rodent
- Low Smoke Zero Halogen

Note

Conductor Shape

10 mm² supplied in solid (re) or non compacted circular stranded (rm) conductor shape

16 - 35 mm² supplied in non compacted circular stranded (rm) or compacted circular stranded (cm)

50 - 400 mm² supplied in non compacted circular stranded (rm) or compacted circular stranded (cm) or sectorshaped stranded (sm) conductor

Standard Packing

10 - 120 mm² supplied in wooden drum @1000 meters

150 - 300 mm² supplied in wooden drum on available length
Length Tolerance per drum ± 2%



Aluminium Conductor

XLPE Insulation

PVC Inner Sheath

Black PVC Outer Sheath

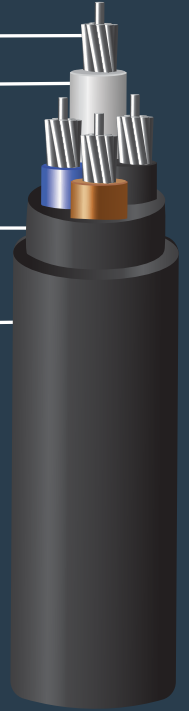

Application:

Power cable: Indoors, cable trunking, outdoors and buried in the ground, for power stations, industry and switchgear as well as for urban supply networks, if mechanical damage is unlikely.

Electrical Data

Nom Cross Section Area mm ²	Conductor		inductance (mH/km)	Current - Carrying Capacity at 30°C		Short Circuit current at 1 second Max. (kA)
	DC Resistance at 20°C Max (Ω/km)	AC Resistance at 90°C Max (Ω/km)		in Air Max. (A)	in Ground Max. (A)	
10	3.08	3.949	0.264	52	60	0.94
16	1.91	2.449	0.253	75	84	1.51
25	1.20	1.539	0.254	110	110	2.36
35	0.868	1.113	0.247	123	132	3.31
50	0.641	0.822	0.242	149	156	4.72
70	0.443	0.568	0.238	189	193	6.61
95	0.320	0.411	0.232	233	232	8.98
120	0.253	0.325	0.229	271	268	11.34
150	0.206	0.265	0.230	310	296	14.17
185	0.164	0.212	0.231	359	336	17.48
240	0.125	0.162	0.227	429	393	22.68
300	0.100	0.130	0.226	496	447	28.35

* Further information about rating factor for certain cable arrangement can be found on supplementary technical information



VOKSEL KABEL

NYAF 1.5 x 300 mm² 450/ 750 V CU-Flex/PVC

(Copper-Flexible Conductor Class 5, PVC Insulated)
Standard Specification : SPLN 42- 3, SNI 04-6629.5, IEC 60227-1

Construction Data

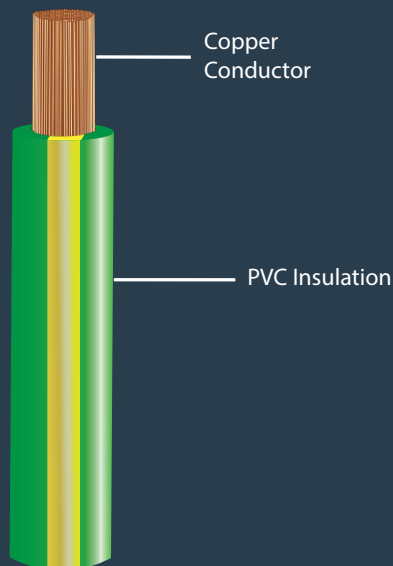

Copper
Conductor

PVC Insulation

Special Features on Request

- Fire Resistance
- Oil Resistance
- Retardant Flame Non Category

Note
Conductor Shape
Flexible of annealed copper wires (Class.5)

Standard Packing
1.5 - 16 sqmm supplied in coil @ 100 meters
25 - 300 sqmm supplied in wooden drum
@ 1000 meters
Length Tolerance per drum ± 2%

Application:
For building wire installed in conduit in
dry location and interwiring in switch board
and control panel.

Nominal Cross Section Area	Overall Diameter	Cable Weight
	approx	approx
mm ²	mm	kg/km
1.5	3.0	20
2.5	3.5	30
4	4.5	50
6	5.0	70
10	6.0	110
16	7.5	175
25	9.5	275
35	10.5	370
50	13.0	555
70	14.5	730
95	17.0	960
120	19.0	1,200
150	20.5	1,435
185	24.0	1,910
240	27.0	2,500
300	29.5	3,050

Electrical Data

Nom Cross Section Area mm ²	Conductor		insulation	inductance	Current - Carrying Capacity at 30°C		Short Circuit current at 1 second Max. (kA)
	DC Resistance at 20°C Max (Ω/km)	AC Resistance at 70°C Max (Ω/km)	Insulation Resistance at 70°C Min. (M.Ω.km)	(mH/km)	in Pipe Max. (A)	in Air Max. (A)	
1.5	12.1	14.478	0.0100	0.320	15	24	0.17
2.5	7.41	8.866	0.0900	0.309	19	32	0.28
4	4.61	5.516	0.0077	0.290	25	42	0.45
6	3.08	3.685	0.0065	0.276	33	54	0.68
10	1.83	2.190	0.0065	0.274	45	73	1.13
16	1.15	1.376	0.0050	0.260	61	98	1.81
25	0.727	0.870	0.0050	0.257	83	129	2.82
35	0.524	0.627	0.0040	0.249	103	158	3.45
50	0.387	0.464	0.0045	0.248	132	197	5.65
70	0.268	0.321	0.0035	0.240	165	245	7.91
95	0.193	0.232	0.0032	0.239	207	290	10.73
120	0.153	0.184	0.0032	0.235	235	345	13.56
150	0.124	0.150	0.0032	0.235	-	390	16.94
185	0.0991	0.121	0.0032	0.235	-	445	20.90
240	0.0754	0.093	0.0032	0.233	-	525	27.11
300	0.0601	0.075	0.0030	0.232	-	605	33.89

* Further information about rating factor for certain cable arrangement can be found on supplementary technical information

NAYY 1 x (10- 500) mm² 0.6/1 kV AL/PVC/PVC

(Aluminium Conductor, PVC Insulated, PVC Sheathed)
Standard Specification : SPLN 43 - 1 & IEC 60502 - 1



Construction Data

Nominal Cross Section Area	Overall Diameter	Cable Weight
	approx	approx
mm ²	mm	kg/km
10	9.0	105
16	10.0	135
25	12.0	190
35	13.0	230
50	15.0	305
70	17.0	395
95	19.5	515
120	21.0	610
150	23.0	740
185	25.5	915
240	29.0	1,160
300	32.0	1,425
400	36.0	1,825
500	39.5	2,200

Special Features on Request

- Oil Resistance
- UV Resistance
- Retardant Flame Cat A, B, C
- Retardant Flame Non Category
- Heat Resistance
- Anti Termite
- Anti Rodent
- Low Smoke Zero Halogen

Note

Conductor Shape

10 - 16 mm² supplied in solid (re) or non compacted circular stranded (rm) conductor shape

25 - 500 mm² supplied in non compacted circular stranded (rm) or compacted circular stranded (cm) conductor shape

Standard Packing

10 - 500 mm² supplied in wooden drum
@1000 meters
Length Tolerance per drum ± 2%

Aluminium Conductor

PVC Insulation

Black PVC
Outer Sheath



Application:

Power cable: Indoors, cable trunking, outdoors and buried in the ground, for power stations, industry and switchgear as well as for urban supply networks. if mechanical damage is unlikely.

Electrical Data

Conductor			insulation	inductance	Current - Carrying Capacity at 30°C		Short Circuit current at 1 second Max. (kA)
Nom Cross Section Area mm ²	DC Resistance at 20°C Max (Ω/km)	AC Resistance at 70°C Max (Ω/km)	Insulation Resistance at 20°C Min. (M.Ω.km)	(mH/km)	in Air Max. (A)	in Ground Max. (A)	
10	3.08	3.701	50	0.362	58	74	0.76
16	1.91	2.295	40	0.336	82	102	1.22
25	1.20	1.442	40	0.327	110	139	1.90
35	0.868	1.043	40	0.311	135	160	2.66
50	0.641	0.770	30	0.292	165	191	3.80
70	0.443	0.533	30	0.283	210	240	5.32
95	0.320	0.385	30	0.276	260	290	7.22
120	0.253	0.305	30	0.269	300	335	9.12
150	0.206	0.249	20	0.267	350	375	11.40
185	0.164	0.198	20	0.261	400	425	14.07
240	0.125	0.152	20	0.258	480	500	18.25
300	0.100	0.122	20	0.255	550	570	22.81
400	0.0778	0.096	20	0.252	660	660	27.19
500	0.0605	0.076	20	0.250	780	765	33.99

* Further information about rating factor for certain cable arrangement can be found on supplementary technical information



VOKSEL KABEL

NAYY 2 x (10 - 300) mm² 0.6 X 1 kV AL/ PVC/PVC

(Aluminium Conductor, PVC Insulated, PVC Sheathed)
Standard Specification : SPLN 43-1, IEC 60502-1, SNI 60502-1

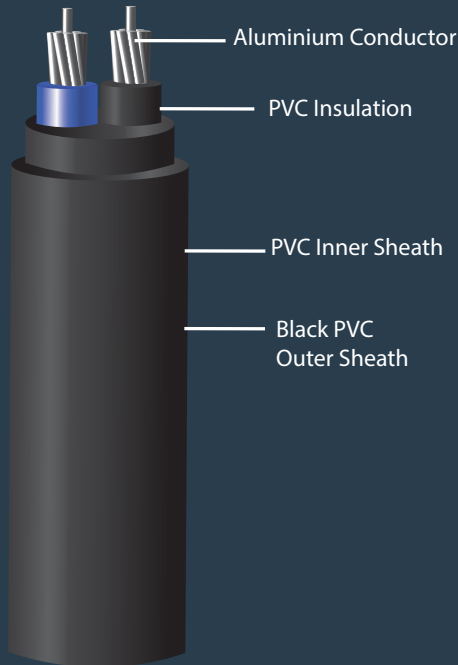

Special Features on Request

- Oil Resistance
- UV Resistance
- Retardant Flame Cat A, B, C
- Retardant Flame Non Category
- Heat Resistance
- Anti Termite
- Anti Rodent
- Low Smoke Zero Halogen

Note

Conductor Shape

10 mm² supplied in solid (re) or non compacted circular stranded (rm) conductor shape
16 - 300 mm² supplied in non compacted circular stranded (rm) or compacted circular stranded (cm) conductor shape

Standard Packing

10 - 150 mm² supplied in wooden drum @1000 meters
185 - 300 mm² supplied in wooden drum on available length
Length Tolerance per drum ± 2%

Construction Data

Nominal Cross Section Area	Overall Diameter	Cable Weight
	approx	approx
mm ²	mm	kg/km
10	18.0	420
16	20.0	535
25	24.5	745
35	27.0	910
50	31.0	1,225
70	35.0	1,595
95	41.0	2,070
120	44.5	2,490
150	49.0	3,010
185	54.0	3,690
240	60.5	4,740
300	67.0	5,795

Application:

Power cable : Indoors, cable trunking, outdoors and buried in the ground, for power stations, industry and switchgear as well as for urban supply networks, if mechanical damage is unlikely.

Electrical Data

Conductor			insulation	inductance	Current - Carrying Capacity at 30°C		Short Circuit current at 1 second Max. (kA)
Nom Cross Section Area mm ²	DC Resistance at 20°C Max (Ω/km)	AC Resistance at 70°C Max (Ω/km)	Insulation Resistance at 20°C Min. (M.Ω.km)	(mH/km)	in Air Max. (A)	in Ground Max. (A)	
10	3.08	3.701	50	0.286	48	59	0.76
16	1.91	2.295	40	0.271	70	79	1.22
25	1.20	1.442	40	0.269	94	102	1.90
35	0.868	1.043	40	0.260	115	125	2.66
50	0.641	0.770	30	0.249	140	147	3.80
70	0.443	0.533	30	0.241	155	156	5.32
95	0.320	0.385	30	0.241	190	191	7.22
120	0.253	0.305	30	0.234	220	220	9.12
150	0.206	0.248	20	0.234	245	245	11.40
185	0.164	0.198	20	0.234	275	275	14.07
240	0.125	0.152	20	0.231	320	320	18.25
300	0.100	0.122	20	0.230	365	365	22.81

* Further information about rating factor for certain cable arrangement can be found on supplementary technical information

NAYY 3 x (10- 400) mm² 0.6/1 kV AL/PVC/PVC

(Aluminium Conductor, PVC Insulated, PVC Sheathed)
Standard Specification : SPLN 43-1, IEC 60502-1, SNI 60502-1



Construction Data

Nominal Cross Section Area mm ²	Overall Diameter	Cable Weight
	approx mm	approx kg/km
10	19.0	470
16	21.0	605
25	26.0	845
35	28.0	1045
50	33.5	1,445
70	37.0	1,835
95	43.0	2,390
120	47.5	2,870
150	52.0	3,475
185	58.0	4,330
240	65.0	5,480
300	71.0	6,710
400	80.5	8,615

Special Features on Request

- Oil Resistance
- UV Resistance
- Retardant Flame Cat A, B, C
- Retardant Flame Non Category
- Heat Resistance
- Anti Termite
- Anti Rodent
- Low Smoke Zero Halogen

Note

Conductor Shape

10 mm² supplied in solid (re) or non compacted circular stranded (rm) conductor shape
16 - 800 mm² supplied in non compacted circular stranded (rm) or compacted circular stranded (cm) conductor shape

Standard Packing

10 - 800 mm² supplied in wooden drum
@1000 meters
Length Tolerance per drum ± 2%

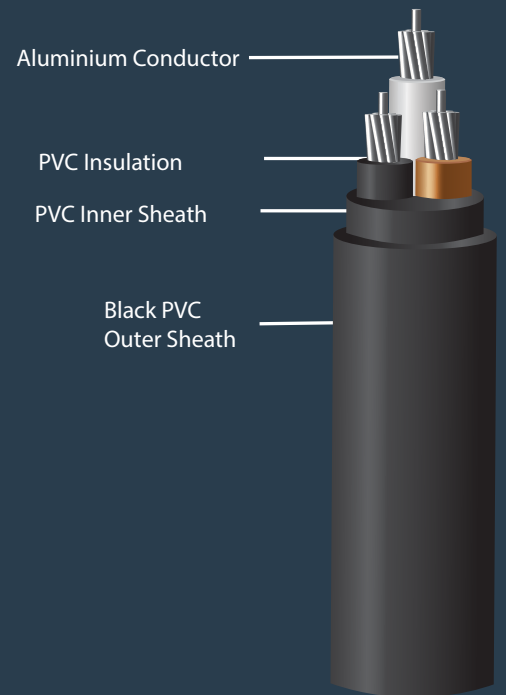

Application:

Power cable: Indoors, cable trunking, outdoors and buried in the ground, for power stations, industry and switchgear as well as for urban supply networks, if mechanical damage is unlikely.

Electrical Data

Nom Cross Section Area mm ²	Conductor		insulation	inductance	Current - Carrying Capacity at 30°C		Short Circuit current at 1 second Max. (kA)
	DC Resistance at 20°C Max (Ω/km)	AC Resistance at 70°C Max (Ω/km)	Insulation Resistance at 20°C Min. (M.Ω.km)	(mH/km)	in Air Max. (A)	in Ground Max. (A)	
10	3.08	3.701	50	0.286	44	52	0.76
16	1.91	2.295	40	0.271	62	69	1.22
25	1.20	1.442	40	0.269	82	89	1.90
35	0.868	1.043	40	0.260	100	107	2.66
50	0.641	0.770	30	0.249	125	129	3.80
70	0.443	0.533	30	0.241	155	156	5.32
95	0.320	0.385	30	0.241	190	191	7.22
120	0.253	0.305	30	0.234	220	220	9.12
150	0.206	0.249	20	0.234	250	245	11.40
185	0.164	0.198	20	0.234	285	275	14.07
240	0.125	0.152	20	0.231	340	320	18.25
300	0.100	0.122	20	0.230	390	365	22.81
400	0.0778	0.096	20	0.228	460	420	27.19

* Further information about rating factor for certain cable arrangement can be found on supplementary technical information



VOKSEL KABEL

NAYY 4 x (10 - 300) mm² 0.6 X 1 kV AL/ PVC/PVC

(Aluminium Conductor, PVC Insulated, PVC Sheathed)
Standard Specification : SPLN 43-1, IEC 60502-1, SNI 60502-1

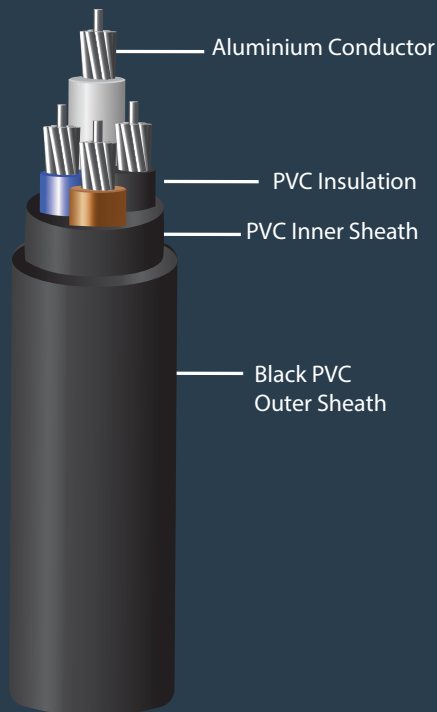

Special Features on Request

- Oil Resistance
- UV Resistance
- Retardant Flame Cat A, B, C
- Retardant Flame Non Category
- Heat Resistance
- Anti Termite
- Anti Rodent
- Low Smoke Zero Halogen

Note

Conductor Shape

10 mm² supplied in solid (re) or non compacted circular stranded (rm) conductor shape

16 - 35 mm² supplied in non compacted circular stranded (rm) or compacted circular stranded (cm) conductor shape

50 - 400 mm² supplied in non compacted circular stranded (rm) or compacted circular stranded (cm) or sector shaped stranded (sm) conductor

Standard Packing

10 - 120 mm² supplied in wooden drum @1000 meters

150 - 400 mm² supplied in wooden drum on available length

Length Tolerance per drum ± 2%

Construction Data

Nominal Cross Section Area	Overall Diameter	Cable Weight
	approx	approx
mm ²	mm	kg/km
10	20.5	555
16	23.0	720
25	28.0	1015
35	31.0	1,265
50	33.0	1,370
70	37.0	1,755
95	44.0	2,295
120	47.0	2,725
150	52.5	3,315
185	58.0	4,120
240	64.5	5,175
300	70.5	6,310
400	79.5	8,120

Application:

Power cable : Indoors, cable trunking, outdoors and buried in the ground, for power stations, industry and switchgear as well as for urban supply networks, if mechanical damage is unlikely.

Electrical Data

Nom Cross Section Area mm ²	Conductor		insulation	inductance	Current - Carrying Capacity at 30°C		Short Circuit current at 1 second Max. (kA)
	DC Resistance at 20°C Max (Ω/km)	AC Resistance at 70°C Max (Ω/km)	Insulation Resistance at 20°C Min. (M.Ω.km)	(mH/km)	in Air Max. (A)	in Ground Max. (A)	
10	3.08	3.701	50	0.286	44	52	0.76
16	1.91	2.295	40	0.271	62	69	1.22
25	1.20	1.442	40	0.269	82	89	1.90
35	0.868	1.043	40	0.260	100	107	2.66
50	0.641	0.770	30	0.259	125	129	3.80
70	0.443	0.533	30	0.249	155	156	5.32
95	0.320	0.385	30	0.247	190	191	7.22
120	0.253	0.305	30	0.240	220	220	9.12
150	0.206	0.248	20	0.240	250	245	11.40
185	0.164	0.198	20	0.239	285	275	14.07
240	0.125	0.152	20	0.236	340	320	18.25
300	0.100	0.122	20	0.236	390	365	22.81
400	0.0778	0.096	20	0.234	460	420	27.19

* Further information about rating factor for certain cable arrangement can be found on supplementary technical information

NYA 1.5 x 400 mm² 450/ 750 V CU/PVC

(Copper Conductor PVC Insulated)
Standard Specification : SPLN 42-1, SNI 04-6629, IEC 60227



VOKSEL KABEL

Construction Data

Nominal Cross Section Area	Overall Diameter	Cable Weight
	approx	approx
mm ²	mm	kg/km
1.5	3.0	20
2.5	3.5	30
4	4.0	45
6	4.5	65
10	5.5	105
16	7.5	170
25	9.0	270
35	10.0	360
50	12.0	490
70	13.5	685
95	16.0	945
120	17.5	1,185
150	19.5	1,450
185	21.5	1,805
240	24.5	2,360
300	27.5	2,960
400	31.0	3,780

Special Features on Request

- Retardant Flame Non Category

Note

Conductor Shape

1.5 - 10 mm² supplied in solid (re) or non compacted circular stranded (rm) conductor shape

16 - 400 mm² supplied in non compacted circular stranded (rm) conductor shape

Standard Packing

15 - 16 mm² supplied in coil @100 meters

25 - 400 mm² supplied in wooden drum @1000 meters

Length Tolerance per drum ± 2%

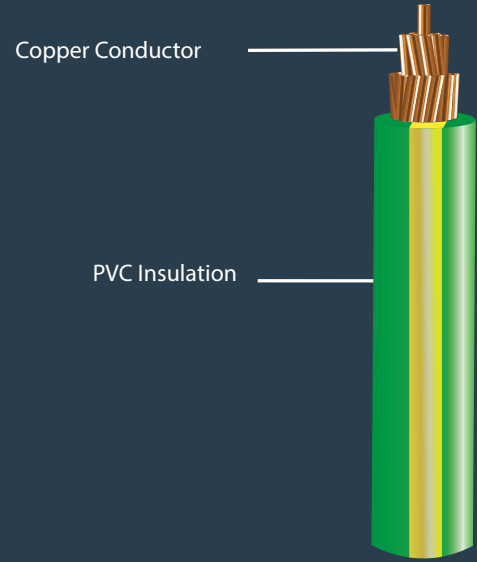

Application:

For building wire installed in conduit in dry location and interwiring in switch board and control panel.

Electrical Data

Nom Cross Section Area mm ²	Conductor		insulation	inductance	Current - Carrying Capacity at 30°C		Short Circuit current at 1 second Max. (kA)
	DC Resistance at 20°C Max (Ω/km)	AC Resistance at 70°C Max (Ω/km)	Insulation Resistance at 70°C Min. (M.Ω.km)	(mH/km)	in Pipe Max. (A)	in Air Max. (A)	
1.5	12.1	14.478	0.0100	0.336	15	24	0.17
2.5	7.41	8.866	0.0900	0.324	19	32	0.28
4	4.61	5.516	0.0077	0.301	25	42	0.46
6	3.08	3.685	0.0065	0.286	33	54	0.69
10	1.83	2.190	0.0065	0.283	45	73	1.15
16	1.15	1.376	0.0050	0.272	61	98	1.84
25	0.727	0.870	0.0050	0.270	83	129	2.88
35	0.524	0.627	0.0040	0.261	103	158	4.03
50	0.387	0.464	0.0045	0.252	132	197	5.75
70	0.268	0.321	0.0035	0.243	165	245	8.05
95	0.193	0.232	0.0032	0.242	207	290	10.93
120	0.153	0.184	0.0032	0.235	235	345	13.80
150	0.124	0.150	0.0032	0.235	-	390	17.25
185	0.0991	0.121	0.0032	0.234	-	445	21.28
240	0.0754	0.093	0.0032	0.231	-	525	27.60
300	0.0601	0.075	0.0030	0.230	-	605	34.50
400	0.0470	0.060	0.0028	0.229	-	725	41.12

* Further information about rating factor for certain cable arrangement can be found on supplementary technical information



VOKSEL KABEL

NYB(AL)Y 1 x (16 - 500) mm² 0.6/1 kV CU/ PVC/ DATA/ PVC

(Copper Conductor, PVC Insulated, Double Aluminium Tape Armor, PVC Sheathed)
Standard Specification : IEC 60502-1, SPLN 43-3, SNI 60502-1

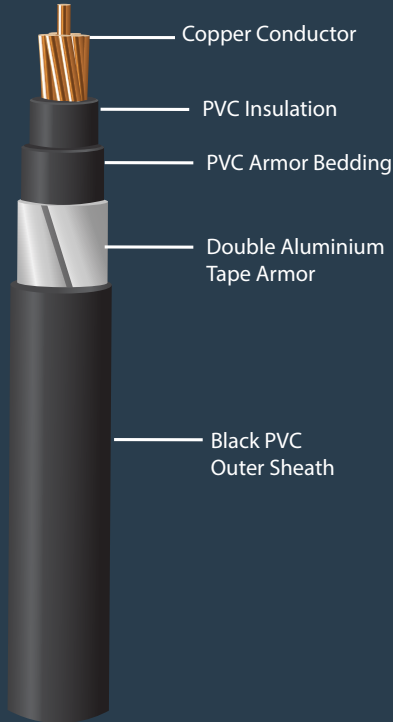

Special Features on Request

- Oil Resistance
- UV Resistance
- Retardant Flame Cat A, B, C
- Retardant Flame Non Category
- Hear Retardant
- Anti Termite
- Anti Rodent
- Low Smoke Zero Halogen

Note Conductor Shape

16 mm² supplied in non compacted circular stranded (rm) conductor shape

25 - 500 mm² supplied in non compacted circular stranded (rm) or compacted circular stranded (cm) conductor shape

Standard Packing

16 - 300 mm² supplied in wooden drum @1000 meters
400 - 500 mm² supplied in wooden drum on available length
Length Tolerance per drum ± 2%

Construction Data

Nominal Cross Section Area	Overall Diameter	Cable Weight
	approx	approx
mm ²	mm	kg/km
16	15.0	375
25	16.5	500
35	17.5	615
50	19.5	775
70	21.0	1005
95	23.5	1,310
120	25.0	1,575
150	27.0	1,880
185	29.5	2,290
240	32.5	2,920
300	36.0	3,630
400	39.5	4,545
500	43.5	5,670

Application:

For installation indoors, cable channels and in ground, for industry insatallations, switchgear, and power station, if there is a risk that low mechanical damage may occur

Electrical Data

Nom Cross Section Area mm ²	Conductor		insulation	inductance	Current - Carrying Capacity at 30°C		Short Circuit current at 1 second Max. (kA)
	DC Resistance at 20°C Max (Ω/km)	AC Resistance at 70°C Max (Ω/km)	Insulation Resistance at 20°C Min. (M.Ω.km)	(mH/km)	in Air Max. (A)	in Ground Max. (A)	
16	1.15	1.376	40	0.418	105	129	1.84
25	0.727	0.870	40	0.395	140	169	2.88
35	0.524	0.627	40	0.375	175	210	4.03
50	0.387	0.463	30	0.352	215	250	5.75
70	0.268	0.321	30	0.333	270	310	8.05
95	0.193	0.232	30	0.321	335	375	10.93
120	0.153	0.184	30	0.307	390	425	13.80
150	0.124	0.150	20	0.302	445	480	17.25
185	0.0991	0.120	20	0.296	510	550	21.28
240	0.0754	0.093	20	0.288	620	640	27.60
300	0.0601	0.075	20	0.285	710	730	34.50
400	0.0470	0.060	20	0.279	850	855	41.12
500	0.0366	0.049	20	0.274	1000	990	51.40

* Further information about rating factor for certain cable arrangement can be found on supplementary technical information

NYBY 2 x (1.5 - 300) mm² 0.6/1 kV CU/PVC/DSTA/PVC

(Copper Conductor, PVC Insulated, Double Steel Tape Armor, PVC Sheathed)
Standard Specification : IEC 60502-1, SPLN 43-3, SNI 60502-1



Construction Data

Nominal Cross Section Area	Overall Diameter	Cable Weight
	approx	approx
mm ²	mm	kg/km
1.5	13.0	260
2.5	14.0	305
4	17.0	405
6	17.0	480
10	18.5	625
16	21.0	820
25	25.0	1,155
35	27.5	1,440
50	31.0	1,892
70	35.5	2,540
95	42.5	3,715
120	46.0	4,460
150	50.5	5,400
185	55.5	6,570
240	62.5	8,425
300	68.0	10,285

Special Features on Request

- Oil Resistance
- UV Resistance
- Retardant Flame Cat A, B, C
- Retardant Flame Non Category
- Hear Retardant
- Anti Termite
- Anti Rodent
- Low Smoke Zero Halogen

Note

Conductor Shape

15- 10 mm² supplied in solid (re) or non compacted circular stranded (rm) conductor shape

25 - 300 mm² supplied in non compacted circular stranded (rm) or compacted circular stranded (cm) conductor shape

Standard Packing

1.5 - 120 mm² supplied in wooden drum @1000 meters

150 - 300 mm² supplied in wooden drum on available length
Length Tolerance per drum ± 2%

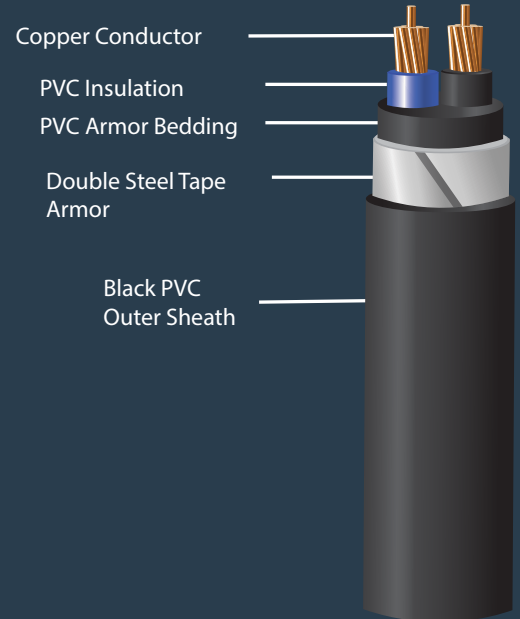

Application:

For installation indoors, cable channels and in ground, for industry installations, switchgear, and power station, if there is a risk that low mechanical damage may occur

Electrical Data

Nom Cross Section Area mm ²	Conductor		insulation	inductance	Current - Carrying Capacity at 30°C		Short Circuit current at 1 second Max. (kA)
	DC Resistance at 20°C Max (Ω/km)	AC Resistance at 70°C Max (Ω/km)	Insulation Resistance at 20°C Min. (M.Ω.km)	(mH/km)	in Air Max. (A)	in Ground Max. (A)	
1.5	12.1	14.478	50	0.349	21	27	0.17
2.5	7.41	8.866	50	0.325	29	36	0.29
4	4.61	5.516	50	0.324	38	47	0.46
6	3.08	3.685	50	0.307	48	59	0.69
10	1.83	2.190	50	0.287	66	78	1.15
16	1.15	1.376	40	0.272	90	102	1.84
25	0.727	0.870	40	0.270	120	134	2.88
35	0.524	0.627	40	0.261	150	160	4.03
50	0.387	0.464	30	0.251	180	187	5.75
70	0.268	0.321	30	0.243	230	230	8.05
95	0.193	0.232	30	0.242	275	280	10.93
120	0.153	0.184	30	0.235	320	320	13.80
150	0.124	0.150	20	0.235	375	355	17.25
185	0.0991	0.121	20	0.234	430	409	21.28
240	0.0754	0.093	20	0.231	510	472	27.60
300	0.0601	0.075	20	0.230	590	525	34.50

* Further information about rating factor for certain cable arrangement can be found on supplementary technical information



VOKSEL KABEL

NYBY 3 x (1.5 - 300) mm² 0.6/1 kV CU/ PVC/DSTA/PVC

(Copper Conductor, PVC Insulated, Double Steel Tape Armor, PVC Sheathed)
Standard Specification : IEC 60502-1, SPLN 43-3, SNI 60502-1

Construction Data

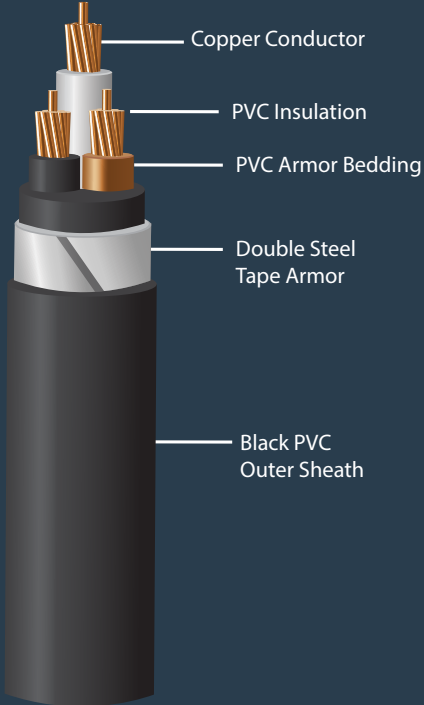

Special Features on Request

- Oil Resistance
- UV Resistance
- Retardant Flame Cat A, B, C
- Retardant Flame Non Category
- Heat Retardant
- Anti Termite
- Anti Rodent
- Low Smoke Zero Halogen

Note

Conductor Shape

1.5 - 10 mm² supplied in solid (re) or non compacted circular stranded (rm) conductor shape
16 mm² supplied in non compacted circular stranded (rm) conductor shape
25 - 300 mm² supplied in non compacted circular stranded (rm) or compacted circular stranded (cm) conductor shape

Standard Packing

15 - 95 mm² supplied in wooden drum @1000 meters
120 - 300 mm² supplied in wooden drum on available length
Length Tolerance per drum ± 2%

Nominal Cross Section Area	Overall Diameter	Cable Weight
	approx	approx
mm ²	mm	kg/km
1.5	13.5	290
2.5	14.5	340
4	16.5	460
6	17.5	555
10	19.5	740
16	22.0	990
25	26.5	1,410
35	29.0	1,785
50	33.5	2,400
70	39.0	3,510
95	45.0	4,635
120	49.0	5,660
150	53.5	6,795
185	59.5	8,365
240	66.5	10,670
300	72.5	13,085

Application:

For installation indoors, cable channels and in ground, for industry installations, switchgear, and power station, if there is a risk that low mechanical damage may occur

Electrical Data

Conductor			insulation	inductance	Current - Carrying Capacity at 30°C		Short Circuit current at 1 second Max. (kA)
Nom Cross Section Area mm ²	DC Resistance at 20°C Max (Ω/km)	AC Resistance at 70°C Max (Ω/km)	Insulation Resistance at 20°C Min. (M.Ω.km)	(mH/km)	in Air Max. (A)	in Ground Max. (A)	
1.5	12.1	14.478	50	0.349	18	24	0.17
2.5	7.41	8.866	50	0.325	25	32	0.29
4	4.61	5.516	50	0.324	34	41	0.46
6	3.08	3.685	50	0.307	44	52	0.69
10	1.83	2.190	50	0.287	60	69	1.15
16	1.15	1.376	40	0.272	80	89	1.84
25	0.727	0.870	40	0.270	105	116	2.88
35	0.524	0.627	40	0.261	130	138	4.03
50	0.387	0.464	30	0.251	160	165	5.75
70	0.268	0.321	30	0.243	200	205	8.05
95	0.193	0.232	30	0.242	245	245	10.93
120	0.153	0.184	30	0.235	285	285	13.80
150	0.124	0.150	20	0.235	325	315	17.25
185	0.0991	0.121	20	0.234	370	355	21.28
240	0.0754	0.093	20	0.231	435	415	27.60
300	0.0601	0.075	20	0.230	500	465	34.50

* Further information about rating factor for certain cable arrangement can be found on supplementary technical information

NYBY 4 x (1.5 - 300) mm² 0.6/1 kV CU/PVC/DSTA/PVC

(Copper Conductor, PVC Insulated, Double Steel Tape Armor, PVC Sheathed)
Standard Specification : IEC 60502-1, SPLN 43-3, SNI 60502-1



Construction Data

Nominal Cross Section Area	Overall Diameter	Cable Weight
	approx	approx
mm ²	mm	kg/km
1.5	14.5	330
2.5	15.5	395
4	17.5	540
6	19.0	660
10	22.0	890
16	23.5	1,205
25	29.0	1,740
35	31.5	2,220
50	34.0	2,660
70	39.5	3,890
95	46.0	5,180
120	49.5	6,310
150	54.5	7,630
185	60.0	9,360
240	66.5	11,915
300	72.5	14,645

Special Features on Request

- Oil Resistance
- UV Resistance
- Retardant Flame Cat A, B, C
- Retardant Flame Non Category
- Hear Retardant
- Anti Termite
- Anti Rodent
- Low Smoke Zero Halogen

Note

Conductor Shape

15 - 10 mm² supplied in solid (re) or non compacted circular stranded (rm) conductor shape
 16 mm² supplied in non compacted circular stranded (rm) conductor shape
 25 - 35 mm² supplied in non compacted circular stranded (rm) or compacted circular stranded (cm) conductor shape
 50 - 400 mm² supplied in non compacted circular stranded (rm) or compacted circular stranded (cm) or sector shaped stranded (sm) conductor

Standard Packing

1.5 - 70 mm² supplied in wooden drum @1000 meters
 95 - 300 mm² supplied in wooden drum on available length
 Length Tolerance per drum ± 2%

Copper Conductor

PVC Insulation

PVC Armor Bedding

Double Steel Tape Armor

Black PVC Outer Sheath

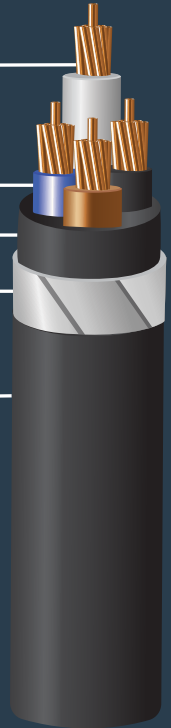

Application:

For installation indoors, cable channels and in ground, for industry installations, switchgear, and power station, if there is a risk that low mechanical damage may occur

Electrical Data

Conductor			insulation	inductance	Current - Carrying Capacity at 30°C		Short Circuit current at 1 second Max. (kA)
Nom Cross Section Area mm ²	DC Resistance at 20°C Max (Ω/km)	AC Resistance at 70°C Max (Ω/km)	Insulation Resistance at 20°C Min. (M.Ω.km)	(mH/km)	in Air Max. (A)	in Ground Max. (A)	
1.5	12.1	14.478	50	0.349	18	24	0.17
2.5	7.41	8.866	50	0.325	25	32	0.29
4	4.61	5.516	50	0.324	34	41	0.46
6	3.08	3.685	50	0.307	44	52	0.69
10	1.83	2.190	50	0.287	60	69	1.15
16	1.15	1.376	40	0.272	80	89	1.84
25	0.727	0.870	40	0.270	105	116	2.88
35	0.524	0.627	40	0.261	130	138	4.03
50	0.387	0.464	30	0.251	160	165	5.75
70	0.268	0.321	30	0.243	200	205	8.05
95	0.193	0.232	30	0.242	245	245	10.93
120	0.153	0.184	30	0.235	285	280	13.80
150	0.124	0.150	20	0.235	325	315	17.25
185	0.0991	0.121	20	0.234	370	355	21.28
240	0.0754	0.093	20	0.231	435	415	27.60
300	0.0601	0.075	20	0.230	500	465	34.50

* Further information about rating factor for certain cable arrangement can be found on supplementary technical information



VOKSEL KABEL

NYFGbY 2 x (25 - 300) mm² 0.6/1 kV CU/ PVC/SFA/PVC

(Circular Stranded Copper Conductor (rm), PVC Insulated, Galvanized Steel Flat Armor, PVC Sheathed)
Standard Specification : IEC 60502-1, SPLN 43-2, SNI 60502-1

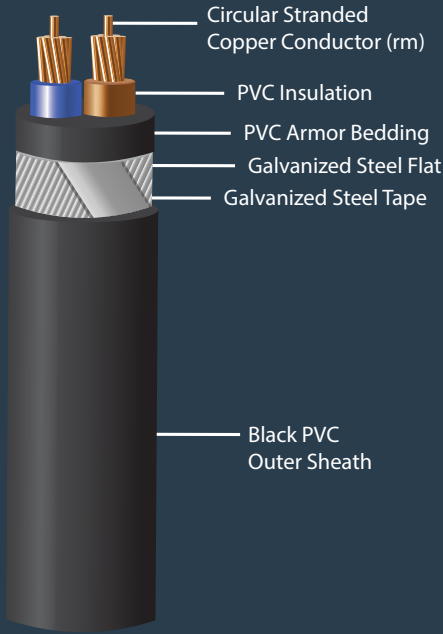

Special Features on Request

- Oil Resistance
- UV Resistance
- Retardant Flame Cat A, B, C
- Retardant Flame Non Category
- Heat Retardant
- Anti Termite
- Anti Rodent
- Low Smoke Zero Halogen

Note

Conductor Shape

25 - 500 mm² supplied in non compacted circular stranded (rm) or compacted circular stranded (cm) conductor shape

Standard Packing

25 - 95 mm² supplied in wooden drum @1000 meters
120 - 300 mm² supplied in wooden drum on available length
Length Tolerance per drum ± 2%

Construction Data

Nominal Cross Section Area	Overall Diameter	Cable Weight
	approx	approx
mm ²	mm	kg/km
25	26.5	1,510
35	29.0	1,835
50	32.5	2,355
70	37.0	3,065
95	42.5	3,985
120	46.0	4,750
150	50.5	5,725
185	55.5	6,935
240	62.5	8,835
300	68.5	10,740

Application:

For installation in ground, indoors, cable trunking and outdoors if increased mechanical protection is required or where highpulling stress may occur during installation or operation

Electrical Data

Nom Cross Section Area mm ²	Conductor		insulation	inductance	Current - Carrying Capacity at 30°C		Short Circuit current at 1 second Max. (kA)
	DC Resistance at 20°C Max (Ω/km)	AC Resistance at 70°C Max (Ω/km)	Insulation Resistance at 20°C Min. (M.Ω.km)	(mH/km)	in Air Max. (A)	in Ground Max. (A)	
25	0.727	0.870	40	0.270	120	134	2.88
35	0.524	0.627	40	0.261	150	160	4.03
50	0.387	0.463	30	0.252	180	187	5.75
70	0.268	0.321	30	0.243	230	230	8.05
95	0.193	0.232	30	0.242	275	280	10.93
120	0.153	0.184	30	0.235	320	320	13.8
150	0.124	0.150	20	0.235	375	355	17.25
185	0.0991	0.120	20	0.234	430	409	21.28
240	0.0754	0.093	20	0.231	510	472	27.6
300	0.0601	0.075	20	0.230	590	525	34.5

* Further information about rating factor for certain cable arrangement can be found on supplementary technical information

NYFGbY 3 x (25 - 400) mm² 0.6/1 kV CU/PVC/SFA/PVC

(Circular Stranded Copper Conductor (rm), PVC Insulated, Galvanized Steel Flat Armor, PVC Sheathed)
Standard Specification : IEC 60502-1, SPLN 43-2, SNI 60502-1



Construction Data

Nominal Cross Section Area	Overall Diameter	Cable Weight
	approx	approx
mm ²	mm	kg/km
25	28.0	1,790
35	30.5	2,210
50	35.0	2,895
70	39.0	3,755
95	45.5	4,925
120	49.5	5,975
150	53.5	7,145
185	59.5	8,755
240	66.5	11,115
300	73.0	13,575
400	81.0	17,015

Special Features on Request

- Oil Resistance
- UV Resistance
- Retardant Flame Cat A, B, C
- Retardant Flame Non Category
- Heat Retardant
- Anti Termite
- Anti Rodent
- Low Smoke Zero Halogen

Note

Conductor Shape

25 - 300 mm² supplied in non compacted circular stranded (rm) or compacted circular stranded (cm) conductor shape

Standard Packing

25 - 70 mm² supplied in wooden drum @1000 meters
95 - 400 mm² supplied in wooden drum on available length
Length Tolerance per drum ± 2%

Circular Stranded
Copper Conductor (rm)

PVC Insulation
PVC Armor Bedding
Galvanized Steel Flat
Galvanized Steel Tape

Black PVC
Outer Sheath



Application:

For installation in ground, indoors, cable trunking and outdoors if increased mechanical protection is required or where highpulling stress may occur during installation or operation

Electrical Data

Conductor			insulation	inductance	Current - Carrying Capacity at 30°C		Short Circuit current at 1 second Max. (kA)
Nom Cross Section Area mm ²	DC Resistance at 20°C Max (Ω/km)	AC Resistance at 70°C Max (Ω/km)	Insulation Resistance at 20°C Min. (M.Ω.km)	(mH/km)	in Air Max. (A)	in Ground Max. (A)	
25	0.727	0.870	40	0.270	105	116	2.88
35	0.524	0.627	40	0.261	130	138	4.03
50	0.387	0.464	30	0.252	160	165	5.75
70	0.268	0.321	30	0.243	200	205	8.05
95	0.193	0.232	30	0.242	245	245	10.93
120	0.153	0.184	30	0.235	285	280	13.8
150	0.124	0.150	20	0.235	325	315	17.25
185	0.0991	0.121	20	0.234	370	355	21.28
240	0.0754	0.093	20	0.231	435	415	27.6
300	0.0601	0.075	20	0.230	500	465	34.5
400	0.0470	0.060	20	0.229	600	535	41.12

* Further information about rating factor for certain cable arrangement can be found on supplementary technical information



VOKSEL KABEL

NYFGbY 4 x (16 - 400) mm² 0.6/1 kV CU/ PVC/SFA/PVC

(Circular Stranded Copper Conductor (rm), PVC Insulated, Galvanized Steel Flat Armor, PVC Sheathed)
Standard Specification : IEC 60502-1, SPLN 43-2, SNI 60502-1

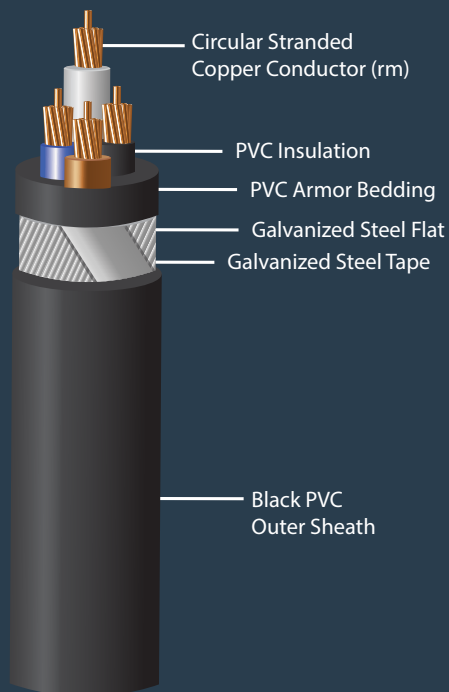

Special Features on Request

- Oil Resistance
- UV Resistance
- Retardant Flame Cat A, B, C
- Retardant Flame Non Category
- Heat Retardant
- Anti Termite
- Anti Rodent
- Low Smoke Zero Halogen

Note

Conductor Shape

16 mm² supplied in non compacted circular stranded (rm) conductor shape

25 - 35 mm² supplied in non compacted circular stranded (rm) or compacted circular stranded (cm) conductor shape

50 - 400 mm² supplied in non compacted circular stranded (rm) or compacted circular stranded (cm) or sector shaped stranded (sm) Conductor

Standard Packing

16 - 50 mm² supplied in wooden drum @1000 meters

70 - 400 mm² supplied in wooden drum on available length

Length Tolerance per drum ± 2%

Construction Data

Nominal Cross Section Area	Overall Diameter	Cable Weight
	approx	approx
mm ²	mm	kg/km
16	25.0	1,550
25	30.5	2,160
35	33.0	2,690
50	35.4	3,120
70	39.5	4,090
95	46.5	5,415
120	49.5	6,555
150	55.0	7,900
185	60.5	9,655
240	67.0	12,250
300	72.5	15,010
400	82.0	20,660

Application:

For installation in ground, indoors, cable trunking and outdoors if increased mechanical protection is required or where highpulling stress may occur during installation or operation

Electrical Data

Nom Cross Section Area mm ²	Conductor		insulation	inductance	Current - Carrying Capacity at 30°C		Short Circuit current at 1 second Max. (kA)
	DC Resistance at 20°C Max (Ω/km)	AC Resistance at 70°C Max (Ω/km)	Insulation Resistance at 20°C Min. (M.Ω.km)	(mH/km)	in Air Max. (A)	in Ground Max. (A)	
16	1.15	1.376	40	0.272	80	89	1.84
25	0.727	0.870	40	0.270	105	116	2.88
35	0.524	0.627	40	0.261	130	138	4.03
50	0.387	0.463	30	0.259	160	165	5.75
70	0.268	0.321	30	0.249	200	205	8.05
95	0.193	0.232	30	0.247	245	245	10.93
120	0.153	0.184	30	0.240	285	280	13.8
150	0.124	0.150	20	0.240	325	315	17.25
185	0.0991	0.120	20	0.239	370	355	21.28
240	0.0754	0.093	20	0.237	435	415	27.6
300	0.0601	0.075	20	0.236	500	465	34.5
400	0.0470	0.060	20	0.234	600	535	41.12

* Further information about rating factor for certain cable arrangement can be found on supplementary technical information

NYFGbY 5 x (16 - 50) mm² 0.6/1 kV CU/PVC/SFA/PVC

(Circular Stranded Copper Conductor (rm), PVC Insulated, Galvanized Steel Flat Armor, PVC Sheathed)
Standard Specification : IEC 60502-1, SPLN 43-2, SNI 60502-1



VOKSEL KABEL

Construction Data

Nominal Cross Section Area	Overall Diameter	Cable Weight
	approx	approx
mm ²	mm	kg/km
16	27.0	1,835
25	33.0	2,585
35	36.5	3,290
50	42.0	4,275

Special Features on Request

- Oil Resistance
- UV Resistance
- Retardant Flame Cat A, B, C
- Retardant Flame Non Category
- Heat Retardant
- Anti Termite
- Anti Rodent
- Low Smoke Zero Halogen

Note

Conductor Shape

16 mm² supplied in non compacted circular stranded (rm) conductor shape
25 - 300 mm² supplied in non compacted circular stranded (rm) or compacted circular stranded (cm) conductor shape

Standard Packing

16 - 50 mm² supplied in wooden drum
@1000 meters
Length Tolerance per drum ± 2%

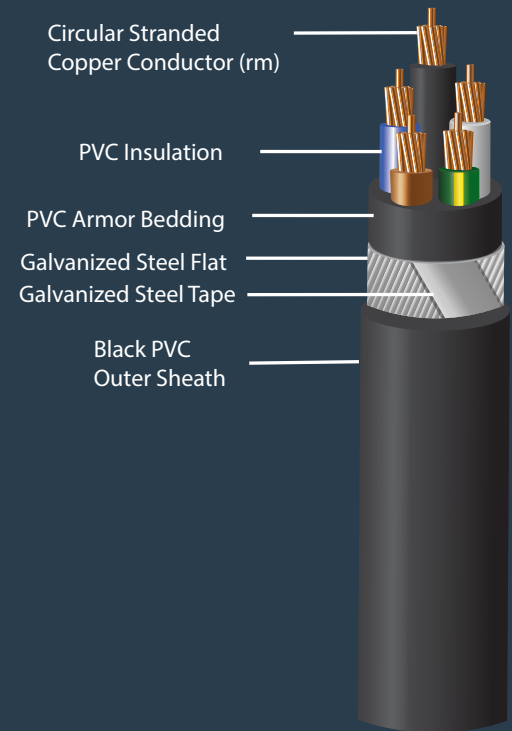

Application:

For installation in ground, indoors, cable trunking and outdoors if increased mechanical protection is required or where highpulling stress may occur during installation or operation

Electrical Data

Nom Cross Section Area mm ²	Conductor		insulation	inductance	Current - Carrying Capacity at 30°C		Short Circuit current at 1 second Max. (kA)
	DC Resistance at 20°C Max (Ω/km)	AC Resistance at 70°C Max (Ω/km)	Insulation Resistance at 20°C Min. (M.Ω.km)	(mH/km)	in Air Max. (A)	in Ground Max. (A)	
16	1.15	1.376	40	0.272	80	89	1.84
25	0.727	0.870	40	0.270	105	116	2.88
35	0.524	0.627	40	0.261	130	138	4.03
50	0.387	0.464	30	0.252	160	165	5.75

* Further information about rating factor for certain cable arrangement can be found on supplementary technical information



VOKSEL KABEL

NYFGbY 2 x (4 - 16) mm² 0.6/1 kV CU/ PVC/SFA/PVC

(Round Solid Copper Conductor (re), PVC Insulated, Galvanized Steel Flat Armor, PVC Sheathed)
Standard Specification : IEC 60502-1, SPLN 43-2, SNI 60502-1

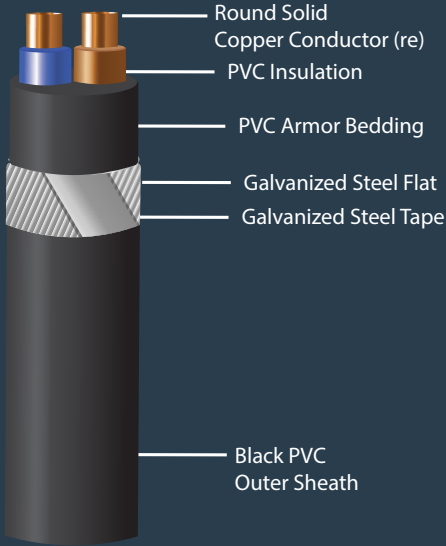

Special Features on Request

- Fire Resistance
- Oil Resistance
- UV Resistance
- Retardant Flame Cat A, B, C
- Retardant Flame Non Category
- Heat Resistance
- Anti Termite
- Anti Rodent
- Low Smoke Zero Halogen

Note

Conductor Shape

16 mm² supplied in non compacted circular stranded (rm) conductor shape
25 - 35 mm² supplied in non compacted circular stranded (rm) or compacted circular stranded (cm) conductor shape
50 - 400 mm² supplied in non compacted circular stranded (rm) or compacted circular stranded (cm) or sector shaped stranded (sm) Conductor

Standard Packing

16 - 50 mm² supplied in wooden drum @1000 meters
70 - 400 mm² supplied in wooden drum on available length
Length Tolerance per drum ± 2%

Construction Data

Nominal Cross Section Area	Overall Diameter	Cable Weight
	approx	approx
mm ²	mm	kg/km
4	16.5	560
6	17.5	640
10	19.0	790
16	22.0	1,080

Application:

For installation in ground, indoors, cable trunking and outdoors if increased mechanical protection is required or where highpulling stress may occur during installation or operation

Electrical Data

Nom Cross Section Area mm ²	Conductor		insulation	inductance	Current - Carrying Capacity at 30°C		Short Circuit current at 1 second Max. (kA)
	DC Resistance at 20°C Max (Ω/km)	AC Resistance at 70°C Max (Ω/km)	Insulation Resistance at 20°C Min. (M.Ω.km)	(mH/km)	in Air Max. (A)	in Ground Max. (A)	
4	4.610	5.516	50	0.604	47	38	0.45
6	3.080	3.685	50	0.577	59	48	0.68
10	1.830	2.190	50	0.542	78	66	1.13
16	1.150	1.376	40	0.499	102	90	1.81

* Further information about rating factor for certain cable arrangement can be found on supplementary technical information

NYFGbY 3 x (4 - 16) mm² 0.6/1 kV CU/PVC/SFA/PVC

(Round Solid Copper Conductor (re), PVC Insulated, Galvanized Steel Wire Armor, PVC Sheathed)
Standard Specification : IEC 60502-1 & SPLN 43-2



Construction Data

Nominal Cross Section Area	Overall Diameter		Cable Weight
	approx	approx	
mm ²	mm	mm	kg/km
4	17.0	17.0	625
6	18.0	18.0	725
10	20.0	20.0	915
16	23.0	23.0	1,270

Special Features on Request

- Fire Resistance
- Oil Resistance
- UV Resistance
- Retardant Flame Cat A, B, C
- Retardant Flame Non Category
- Heat Retardant
- Anti Termite
- Anti Rodent
- Low Smoke Zero Halogen

Note

Conductor Shape

10 mm² supplied in solid (re) non compacted circular stranded (rm) conductor shape
16 mm² supplied in non compacted circular stranded (rm) conductor shape

25 - 335 mm² supplied in non compacted circular stranded (rm) or compacted circular stranded (cm) conductor shape

25 -400 mm² supplied in non compacted circular stranded (rm) or compacted circular stranded (cm) or sector shaped stranded (sm) conductor

Standard Packing

10- 70 mm² supplied in wooden drum @1000 meters
95- 300 mm² supplied in wooden drum on available length
Length Tolerance per drum ± 2%

Round Solid Copper Conductor (re)

PVC Insulation

PVC Armor Bedding

Galvanized Steel Wire Armor

Galvanized Steel Tape

Black PVC Outer Sheath



Application:

For installation in ground, indoors, cable trunking and outdoors if increased mechanical protection is required or where highpulling stress may occur during installation or operation

Electrical Data

Conductor			insulation	inductance	Current - Carrying Capacity at 30°C		Short Circuit current at 1 second Max. (kA)
Nom Cross Section Area mm ²	DC Resistance at 20°C Max (Ω/km)	AC Resistance at 70°C Max (Ω/km)	Insulation Resistance at 20°C Min. (M.Ω.km)	(mH/km)	in Air Max. (A)	in Ground Max. (A)	
4	4.610	5.516	50	0.612	41	34	0.45
6	3.080	3.685	50	0.585	52	44	0.68
10	1.830	2.190	50	0.551	69	60	1.13
16	1.150	1.376	40	0.509	89	80	1.81

* Further information about rating factor for certain cable arrangement can be found on supplementary technical information



VOKSEL KABEL

NYFGbY 4 x (4 - 16) mm² 0.6/1 kV CU/ PVC/SFA/PVC

(Round Solid Copper Conductor (re), PVC Insulated, Galvanized Steel Flat Armor, PVC Sheathed)
Standard Specification : IEC 60502-1, SPLN 43-2, SNI 60502-1

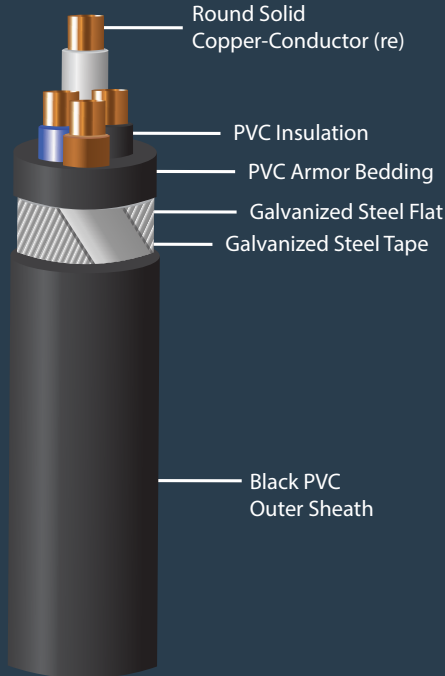

Special Features on Request

- Fire Resistance
- Oil Resistance
- UV Resistance
- Retardant Flame Cat A, B, C
- Retardant Flame Non Category
- Heat Resistance
- Anti Termite
- Anti Rodent
- Low Smoke Zero Halogen

Note

Conductor Shape

16 mm² supplied in non compacted circular stranded (rm) conductor shape
25 - 35 mm² supplied in non compacted circular stranded (rm) or compacted circular stranded (cm) conductor shape
50 - 400 mm² supplied in non compacted circular stranded (rm) or compacted circular stranded (cm) or sector shaped stranded (sm) Conductor

Standard Packing

16 - 50 mm² supplied in wooden drum @1000 meters
70 - 400 mm² supplied in wooden drum on available length
Length Tolerance per drum ± 2%

Construction Data

Nominal Cross Section Area	Overall Diameter	Cable Weight
	approx	approx
mm ²	mm	kg/km
4	18.5	720
6	19.5	840
10	21.5	1,080
16	25.0	1,515

Application:

For installation in ground, indoors, cable trunking and outdoors if increased mechanical protection is required or where highpulling stress may occur during installation or operation

Electrical Data

Conductor			insulation	inductance	Current - Carrying Capacity at 30°C		Short Circuit current at 1 second Max. (kA)
Nom Cross Section Area mm ²	DC Resistance at 20°C Max (Ω/km)	AC Resistance at 70°C Max (Ω/km)	Insulation Resistance at 20°C Min. (M.Ω.km)	(mH/km)	in Air Max. (A)	in Ground Max. (A)	
4	4.610	5.516	50	0.625	41	34	0.45
6	3.080	3.685	50	0.599	52	44	0.68
10	1.830	2.190	50	0.565	69	60	1.13
16	1.150	1.376	40	0.524	89	80	1.81

* Further information about rating factor for certain cable arrangement can be found on supplementary technical information

NYR(AL)Y 1 x (10 - 500) mm² 0.6/1 kV CU/ PVC/ AWA/ PVC

(Copper Conductor, PVC Insulated, Aluminium Wire Armor, PVC Sheathed)
Standard Specification : IEC 60502-1, SPLN 43-2, SNI 60502-1



Construction Data

Nominal Cross Section Area	Overall Diameter	Cable Weight
	approx	approx
mm ²	mm	kg/km
10	14.0	305
16	15.0	385
25	17.0	540
35	18.5	655
50	20.0	820
70	22.5	1,100
95	25.0	1,415
120	26.5	1,690
150	28.5	2,010
185	31.0	2,430
240	35.0	3,165
300	38.5	3,895
400	42.0	4,835
500	47.0	6,140

Special Features on Request

- Oil Resistance
- UV Resistance
- Retardant Flame Cat A, B, C
- Retardant Flame Non Category
- Heat Retardant
- Anti Termite
- Anti Rodent
- Low Smoke Zero Halogen

Note

Conductor Shape

10 - 16 mm² supplied in non compacted circular stranded (rm) conductor shape
25 - 500 mm² supplied in non compacted circular stranded (rm) or compacted circular stranded (cm) conductor shape

Standard Packing

10 - 300 mm² supplied in wooden drum @1000 meters
400 - 500 mm² supplied in wooden drum on available length
Length Tolerance per drum ± 2%

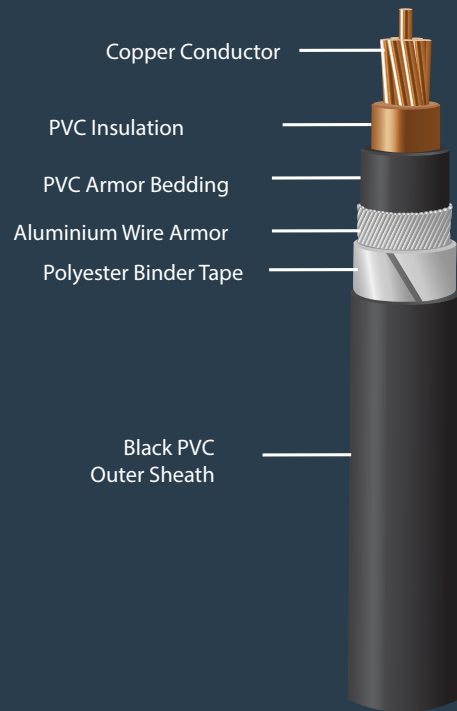

Application:
For installation in ground, indoors, cable trunking and outdoors if increased mechanical protection is required or where highpulling stress may occur during installation or operation

Electrical Data

Nom Cross Section Area mm ²	Conductor		insulation	inductance	Current - Carrying Capacity at 30°C		Short Circuit current at 1 second Max. (kA)
	DC Resistance at 20°C Max (Ω/km)	AC Resistance at 70°C Max (Ω/km)	Insulation Resistance at 20°C Min. (M.Ω.km)	(mH/km)	in Air Max. (A)	in Ground Max. (A)	
10	1.83	2.190	50	0.455	80	98	1.15
16	1.15	1.376	40	0.422	105	129	1.84
25	0.727	0.870	40	0.402	140	169	2.88
35	0.524	0.627	40	0.386	175	210	4.03
50	0.387	0.463	30	0.359	215	250	5.75
70	0.268	0.321	30	0.346	270	310	8.05
95	0.193	0.232	30	0.335	335	375	10.93
120	0.153	0.184	30	0.320	390	425	13.80
150	0.124	0.150	20	0.314	445	480	17.25
185	0.0991	0.120	20	0.307	510	550	21.28
240	0.0754	0.093	20	0.302	620	640	27.60
300	0.0601	0.075	20	0.299	710	730	34.50
400	0.0470	0.060	20	0.292	850	855	41.12
500	0.0366	0.049	20	0.289	1000	990	51.40

* Further information about rating factor for certain cable arrangement can be found on supplementary technical information

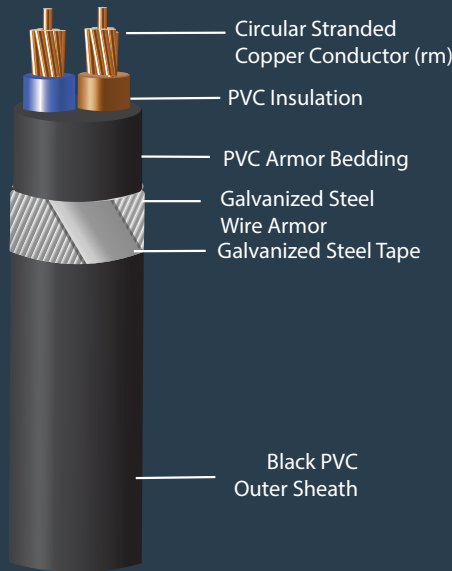

Special Features on Request

- Oil Resistance
- UV Resistance
- Retardant Flame Cat A, B, C
- Retardant Flame Non Category
- Heat Retardant
- Anti Termite
- Anti Rodent
- Low Smoke Zero Halogen

Note

Conductor Shape

10 mm² supplied in solid (re) non compacted circular stranded (rm) conductor shape

16 mm² supplied in non compacted circular stranded (rm) conductor shape

25 - 300 mm² supplied in non compacted circular stranded (rm) or compacted circular stranded (cm) conductor shape

Standard Packing

10- 70 mm² supplied in wooden drum @1000 meters

95- 300 mm² supplied in wooden drum on available length

Length Tolerance per drum ± 2%

Construction Data

Nominal Cross Section Area	Overall Diameter	Cable Weight
	approx	approx
mm ²	mm	kg/km
10	21.0	975
16	24.0	1,340
25	28.0	1,755
35	30.5	2,105
50	34.5	1,875
70	39.5	3,640
95	45.0	4,610
120	50.0	5,825
150	54.0	6,880
185	59.0	8,175
240	66.0	10,185
300	72.0	12,180

Application:

For installation in ground, indoors, cable trunking and outdoors if increased mechanical protection is required or where highpulling stress may occur during installation or operation

Electrical Data

Nom Cross Section Area mm ²	Conductor		insulation Insulation Resistance at 20°C Min. (M.Ω.km)	inductance (mH/km)	Current - Carrying Capacity at 30°C		Short Circuit current at 1 second Max. (kA)
	DC Resistance at 20°C Max (Ω/km)	AC Resistance at 70°C Max (Ω/km)			in Air Max. (A)	in Ground Max. (A)	
10	1.83	2.190	50	0.287	66	78	1.15
16	1.15	1.376	40	0.272	90	102	1.84
25	0.727	0.870	40	0.270	120	134	2.88
35	0.524	0.627	40	0.261	150	160	4.03
50	0.387	0.463	30	0.252	180	187	5.75
70	0.268	0.321	30	0.243	230	230	8.05
95	0.193	0.232	30	0.242	275	280	10.93
120	0.153	0.184	30	0.235	320	320	15.8
150	0.124	0.150	20	0.235	375	355	17.25
185	0.0991	0.120	20	0.234	430	409	21.28
240	0.0754	0.093	20	0.231	510	472	27.60
300	0.0601	0.075	20	0.230	590	525	34.50

* Further information about rating factor for certain cable arrangement can be found on supplementary technical information

NYRgBY 3 x (10 - 400) mm² 0.6/1 kV CU/ PVC/SWA/PVC

(Circular Stranded Copper Conductor (rm), PVC Insulated, Galvanized Steel Wire Armor, PVC Sheathed)
Standard Specification : IEC 60502-1, SPLN 43-2, SNI 60502-1

Construction Data

Nominal Cross Section Area	Overall Diameter	Cable Weight
	approx	approx
mm ²	mm	kg/km
10	22.5	1,235
16	25.0	1,545
25	29.5	2,065
35	32.0	2,505
50	37.5	3,470
70	41.5	4,385
95	49.0	6,025
120	53.0	7,160
150	57.5	8,420
185	63.0	10,140
240	70.0	12,630
300	78.0	16,070
400	86.0	19,735

Special Features on Request

- Oil Resistance
- UV Resistance
- Retardant Flame Cat A, B, C
- Retardant Flame Non Category
- Heat Retardant
- Anti Termite
- Anti Rodent
- Low Smoke Zero Halogen

Note

Conductor Shape

10 mm² supplied in solid (re) or non compacted circular stranded (rm) conductor shape

16 mm² supplied in non compacted circular stranded (rm) conductor shape

25 - 500 mm² supplied in non compacted circular stranded (rm) or compacted circular stranded (cm) conductor shape

Standard Packing

10 - 700 mm² supplied in wooden drum @1000 meters

95 - 400 mm² supplied in wooden drum on available length
Length Tolerance per drum ± 2%



VOKSEL KABEL

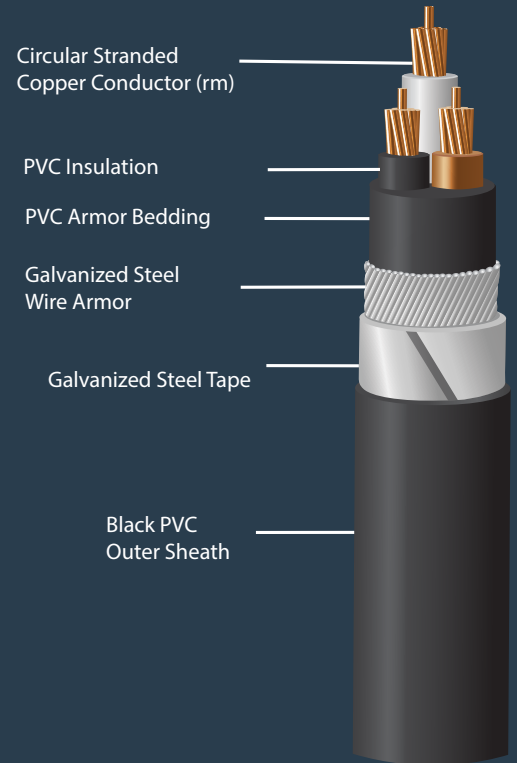

Application:

For installation in ground, indoors, cable trunking and outdoors if increased mechanical protection is required or where highpulling stress may occur during installation or operation

Electrical Data

Nom Cross Section Area mm ²	Conductor		insulation Insulation Resistance at 20°C Min. (M.Ω.km)	inductance (mH/km)	Current - Carrying Capacity at 30°C		Short Circuit current at 1 second Max. (kA)
	DC Resistance at 20°C Max (Ω/km)	AC Resistance at 70°C Max (Ω/km)			in Air Max. (A)	in Ground Max. (A)	
10	1.83	2.190	50	0.287	60	69	1.15
16	1.15	1.376	40	0.272	80	89	1.84
25	0.727	0.870	40	0.270	105	116	2.88
35	0.524	0.627	40	0.261	130	138	4.03
50	0.387	0.463	30	0.252	160	165	5.75
70	0.268	0.321	30	0.243	200	205	8.05
95	0.193	0.232	30	0.242	245	245	10.93
120	0.153	0.184	30	0.235	285	285	13.80
150	0.124	0.150	20	0.235	325	315	17.25
185	0.0991	0.120	20	0.234	370	355	21.28
240	0.0754	0.093	20	0.231	435	415	27.60
300	0.0601	0.075	20	0.230	500	465	34.50
400	0.0470	0.060	20	0.229	600	535	41.12

* Further information about rating factor for certain cable arrangement can be found on supplementary technical information

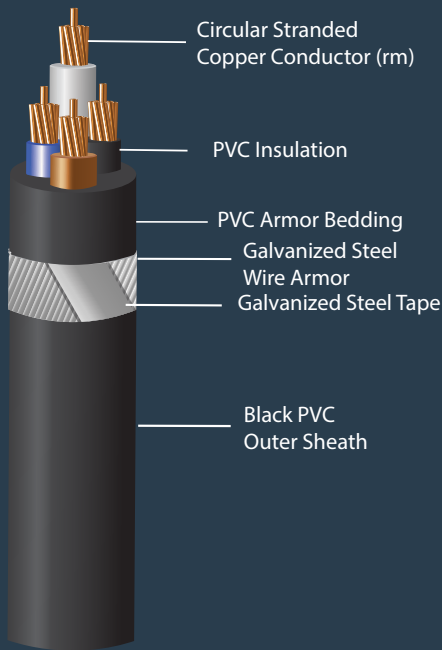

Special Features on Request

- Oil Resistance
- UV Resistance
- Retardant Flame Cat A, B, C
- Retardant Flame Non Category
- Heat Retardant
- Anti Termite
- Anti Rodent
- Low Smoke Zero Halogen

Note

Conductor Shape

10 mm² supplied in solid (re) non compacted circular stranded (rm) conductor shape

16 mm² supplied in non compacted circular stranded (rm) conductor shape

25 - 335 mm² supplied in non compacted circular stranded (rm) or compacted circular stranded (cm) conductor shape

25 - 400 mm² supplied in non compacted circular stranded (rm) or compacted circular stranded (cm) or sector shaped stranded (sm) conductor

Standard Packing

10- 70 mm² supplied in wooden drum @1000 meters

95- 300 mm² supplied in wooden drum on available length
Length Tolerance per drum ± 2%

Construction Data

Nominal Cross Section Area	Overall Diameter	Cable Weight
	approx	approx
mm ²	mm	kg/km
10	24.0	1,430
16	27.0	1,810
25	32.0	2,464
35	36.0	3,255
50	38.0	3,975
70	42.0	5,085
95	50.0	7,035
120	53.0	8,325
150	58.5	9,930
185	64.0	11,970
240	70.5	14,905
300	78.0	18,880
400	87.0	23,490

Application:

For installation in ground, indoors, cable trunking and outdoors if increased mechanical protection is required or where highpulling stress may occur during installation or operation

Electrical Data

Nom Cross Section Area mm ²	Conductor		insulation	inductance	Current - Carrying Capacity at 30°C		Short Circuit current at 1 second Max. (kA)
	DC Resistance at 20°C Max (Ω/km)	AC Resistance at 70°C Max (Ω/km)	Insulation Resistance at 20°C Min. (M.Ω.km)	(mH/km)	in Air Max. (A)	in Ground Max. (A)	
10	1.83	2.190	50	0.287	60	69	1.15
16	1.15	1.376	40	0.272	80	89	1.84
25	0.727	0.870	40	0.270	105	116	2.88
35	0.524	0.627	40	0.261	130	138	4.03
50	0.387	0.463	30	0.259	160	265	5.75
70	0.268	0.321	30	0.249	200	205	8.05
95	0.193	0.232	30	0.247	245	245	10.93
120	0.153	0.184	30	0.240	285	285	13.80
150	0.124	0.150	20	0.240	325	315	17.25
185	0.0991	0.120	20	0.239	370	355	21.28
240	0.0754	0.093	20	0.237	435	415	27.60
300	0.0601	0.075	20	0.236	500	465	34.50
400	0.0470	0.060	20	0.234	600	535	41.12

* Further information about rating factor for certain cable arrangement can be found on supplementary technical information

NYRgBY 2 x (10 - 400) mm² 0.6/1 kV CU/PVC/SWA/PVC

(Round Solid Copper Conductor (re), PVC Insulated, Galvanized Steel Wire Armor, PVC Sheathed)
Standard Specification : IEC 60502-1 & SPLN 43-2



Construction Data

Nominal Cross Section Area	Overall Diameter	Cable Weight
	approx	approx
mm ²	mm	kg/km
1.5	14.0	375
2.5	14.5	430
4	17.0	570
6	18.0	660

Special Features on Request

- Fire Resistance
- Oil Resistance
- UV Resistance
- Retardant Flame Cat A, B, C
- Retardant Flame Non Category
- Heat Retardant
- Anti Termite
- Anti Rodent
- Low Smoke Zero Halogen

Note

Conductor Shape

10 mm² supplied in solid (re) non compacted circular stranded (rm) conductor shape

16 mm² supplied in non compacted circular stranded (rm) conductor shape

25 - 300 mm² supplied in non compacted circular stranded (rm) or compacted circular stranded (cm) conductor shape

Standard Packing

10- 70 mm² supplied in wooden drum @1000 meters

95- 400 mm² supplied in wooden drum on available length
Length Tolerance per drum ± 2%

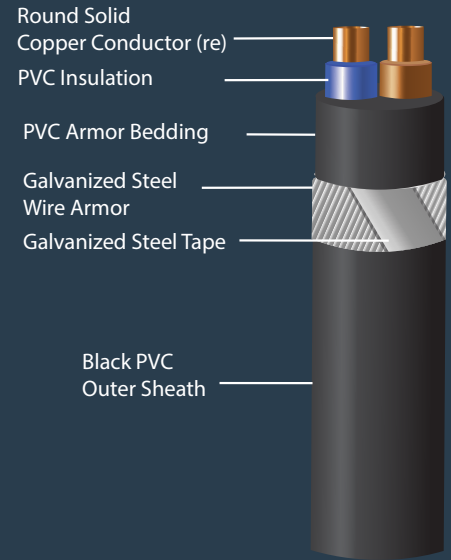

Black PVC Outer Sheath

Application:

For installation in ground, indoors, cable trunking and outdoors if increased mechanical protection is required or where highpulling stress may occur during installation or operation

Electrical Data

Nom Cross Section Area mm ²	Conductor		insulation	inductance (mH/km)	Current - Carrying Capacity at 30°C		Short Circuit current at 1 second Max. (kA)
	DC Resistance at 20°C Max (Ω/km)	AC Resistance at 70°C Max (Ω/km)	Insulation Resistance at 20°C Min. (M.Ω.km)		in Air Max. (A)	in Ground Max. (A)	
1.5	12.10	14.478	50	0.669	27	21	0.17
2.5	7.41	8.866	50	0.630	36	29	0.28
4	4.610	5.516	50	0.585	47	38	0.45
6	3.080	3.685	50	0.559	59	48	0.68



VOKSEL KABEL

NYRgBY 3 x (10 - 400) mm² 0.6/1 kV CU/PVC/SWA/PVC

(Round Solid Copper Conductor (re), PVC Insulated, Galvanized Steel Wire Armor, PVC Sheathed)
Standard Specification : IEC 60502-1 & SPLN 43-2

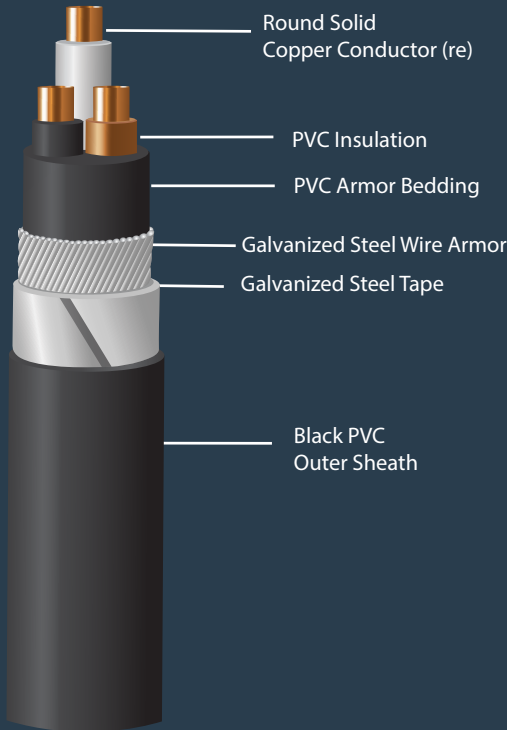

Special Features on Request

- Fire Resistance
- Oil Resistance
- UV Resistance
- Retardant Flame Cat A, B, C
- Retardant Flame Non Category
- Heat Retardant
- Anti Termite
- Anti Rodent
- Low Smoke Zero Halogen

Note

Conductor Shape

10 mm² supplied in solid (re) non compacted circular stranded (rm) conductor shape

16 mm² supplied in non compacted circular stranded (rm) conductor shape

25 - 300 mm² supplied in non compacted circular stranded (rm) or compacted circular stranded (cm) conductor shape

Standard Packing

10- 70 mm² supplied in wooden drum @1000 meters

95- 400 mm² supplied in wooden drum on available length
Length Tolerance per drum ± 2%

Construction Data

Nominal Cross Section Area	Overall Diameter	Cable Weight
	approx	approx
mm ²	mm	kg/km
1.5	14.3	410
2.5	15.1	470
4	18.0	640
6	19.0	750

Application:

For installation in ground, indoors, cable trunking and outdoors if increased mechanical protection is required or where highpulling stress may occur during installation or operation

Electrical Data

Conductor			insulation	inductance	Current - Carrying Capacity at 30°C		Short Circuit current at 1 second Max. (kA)
Nom Cross Section Area mm ²	DC Resistance at 20°C Max (Ω/km)	AC Resistance at 70°C Max (Ω/km)	Insulation Resistance at 20°C Min. (M.Ω.km)	(mH/km)	in Air Max. (A)	in Ground Max. (A)	
1.5	12.10	14.478	50	0.686	24	18	0.17
2.5	7.41	8.866	50	0.648	32	25	0.28
4	4.610	5.516	50	0.606	41	34	0.45
6	3.080	3.685	50	0.581	52	44	0.68

NYRGbY 4 x (10 - 400) mm² 0.6/1 kV CU/PVC/SWA/PVC

(Round Solid Copper Conductor (re), PVC Insulated, Galvanized Steel Wire Armor, PVC Sheathed)
Standard Specification : IEC 60502-1 & SPLN 43-2



Construction Data

Nominal Cross Section Area	Overall Diameter	Cable Weight
	approx	approx
mm ²	mm	kg/km
1.5	15.1	458
2.5	16.0	530
4	19.0	735
6	20.5	870

Special Features on Request

- Fire Resistance
- Oil Resistance
- UV Resistance
- Retardant Flame Cat A, B, C
- Retardant Flame Non Category
- Heat Retardant
- Anti Termite
- Anti Rodent
- Low Smoke Zero Halogen

Note

Conductor Shape

10 mm² supplied in solid (re) non compacted circular stranded (rm) conductor shape
16 mm² supplied in non compacted circular stranded (rm) conductor shape

25 - 35 mm² supplied in non compacted circular stranded (rm) or compacted circular stranded (cm) conductor shape

50 -400 mm² supplied in non compacted circular stranded (rm) or compacted circular stranded (cm) or sector shaped stranded (sm) conductor

Standard Packing

10- 50 mm² supplied in wooden drum @1000 meters
70- 400 mm² supplied in wooden drum on available length
Length Tolerance per drum ± 2%

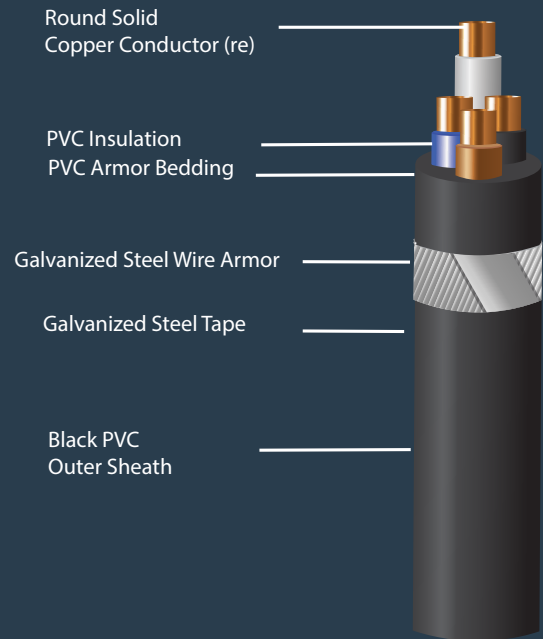

Application:

For installation in ground, indoors, cable trunking and outdoors if increased mechanical protection is required or where highpulling stress may occur during installation or operation

Electrical Data

Nom Cross Section Area mm ²	Conductor		insulation Insulation Resistance at 20°C Min. (M.Ω.km)	inductance (mH/km)	Current - Carrying Capacity at 30°C		Short Circuit current at 1 second Max. (kA)
	DC Resistance at 20°C Max (Ω/km)	AC Resistance at 70°C Max (Ω/km)			in Air Max. (A)	in Ground Max. (A)	
1.5	12.10	14.478	50	0.686	24	18	0.17
2.5	7.41	8.866	50	0.648	32	25	0.28
4	4.610	5.516	50	0.606	41	34	0.45
6	3.080	3.685	50	0.581	52	44	0.68

* Further information about rating factor for certain cable arrangement can be found on supplementary technical information



VOKSEL KABEL

NYM 2 x (1.5 - 35) mm² 300/ 500 V CU/ PVC/ PVC

(Copper Conductor, PVC Insulated, PVC Sheathed)
Standard Specification : SPLN 42 - 2, SNI 04 - 6629.4 & IEC 60227 - 3

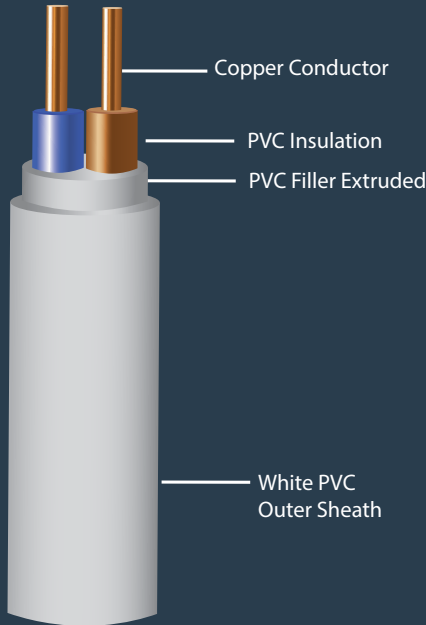

Special Features on Request

- Retardant Flame Non Category

Note

Conductor Shape

1.5 - 10 mm² supplied in solid (re) or non compacted circular stranded (rm) conductor shape
16 - 35 mm² supplied in non compacted circular stranded (rm) conductor shape

Standard Packing

15 - 4 mm² supplied in coil @ 100 meters or in wooden drum @ 1000/ 2000 meters
6 - 35 mm² supplied in wooden drum 1000 meters
Length Tolerance per drum ± 2%

Construction Data

Nominal Cross Section Area	Overall Diameter	Cable Weight
	approx	approx
mm ²	mm	kg/km
1.5	9.0	116
2.5	10.5	157
4	11.5	205
6	12.5	260
10	16.0	425
16	18.5	640
25	23.0	960
35	26.0	1,275

Application:

For building wire installed in conduit in dry location and interconnecting in switch board and control panel, inherently flame retardant in compliance with IEC 60332 - 1

Electrical Data

Nom Cross Section Area mm ²	Conductor		insulation	inductance	Current - Carrying Capacity at 30°C	Short Circuit current at 1 second Max. (kA)
	DC Resistance at 20°C Max (Ω/km)	AC Resistance at 70°C Max (Ω/km)	Insulation Resistance at 70°C Min. (M.Ω.km)	(mH/km)	in Air Max. (A)	
1.5	12.1	14.478	0.0100	0.335	19	0.17
2.5	7.41	8.866	0.0900	0.325	25	0.29
4	4.61	5.516	0.0077	0.297	34	0.45
6	3.08	3.685	0.0065	0.290	44	0.69
10	1.83	2.190	0.0065	0.287	61	1.15
16	1.15	1.376	0.0052	0.272	82	1.84
25	0.727	0.870	0.0050	0.270	108	2.88
35	0.524	0.627	0.0044	0.261	134	4.03

* Further information about rating factor for certain cable arrangement can be found on supplementary technical information

NYM 3 x (1.5 - 35) mm² 300/ 500 V CU/PVC/PVC

(Copper Conductor, PVC Insulated, PVC Sheathed)
Standard Specification : SPLN 42 - 2, SNI 04 - 6629.4 & IEC 60227 - 3

Construction Data

Nominal Cross Section Area	Overall Diameter	Cable Weight
	approx	approx
mm ²	mm	kg/km
1.5	9.5	135
2.5	11.0	185
4	12.0	250
6	13.5	335
10	16.5	530
16	20.0	815
25	24.0	1,225
35	27.0	1,605

Special Features on Request

- Retardant Flame Non Category

Note

Conductor Shape

1.5 - 10 mm² supplied in solid (re) or non compacted circular stranded (rm) conductor shape
16 - 35 mm² supplied in non compacted circular stranded (rm) conductor shape

Standard Packing

1.5 - 4 mm² supplied in coil @100 meters or in wooden drum @1000 / 2000 meters
16 - 35mm² supplied in wooden drum on 1000 meters
Length Tolerance per drum ± 2%



VOKSEL KABEL

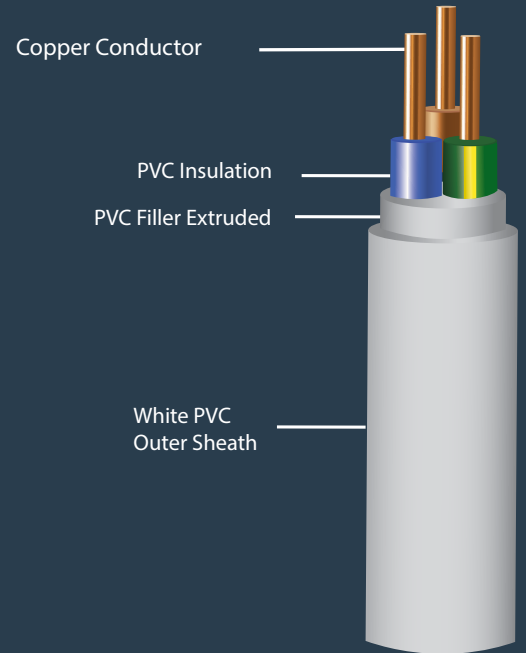

Application:

For building wire installed in conduit in dry location and interlocking in switch board and control panel, inherently flame retardant in compliance with IEC 60332 - 1

Electrical Data

Nom Cross Section Area mm ²	Conductor		insulation	inductance	Current - Carrying Capacity at 30°C	Short Circuit current at 1 second Max. (kA)
	DC Resistance at 20°C Max (Ω/km)	AC Resistance at 70°C Max (Ω/km)	Insulation Resistance at 70°C Min. (M.Ω.km)	(mH/km)	in Air Max. (A)	
1.5	12.1	14.478	0.0100	00.335	19	0.17
2.5	7.41	8.866	0.0900	0.325	25	0.29
4	4.61	5.516	0.0077	0.297	34	0.45
6	3.08	3.685	0.0065	0.290	44	0.69
10	1.83	2.190	0.0065	0.287	61	1.15
16	1.15	1.376	0.0052	0.272	82	1.84
25	0.727	0.870	0.0050	0.270	108	2.88
35	0.524	0.627	0.0044	0.261	134	4.03

* Further information about rating factor for certain cable arrangement can be found on supplementary technical information



VOKSEL KABEL

NYM 4 x (1.5 - 35) mm² 300/ 500 V CU/ PVC/ PVC

(Copper Conductor, PVC Insulated, PVC Sheathed)
Standard Specification : SPLN 42 - 2, SNI 04 - 6629.4 & IEC 60227 - 3

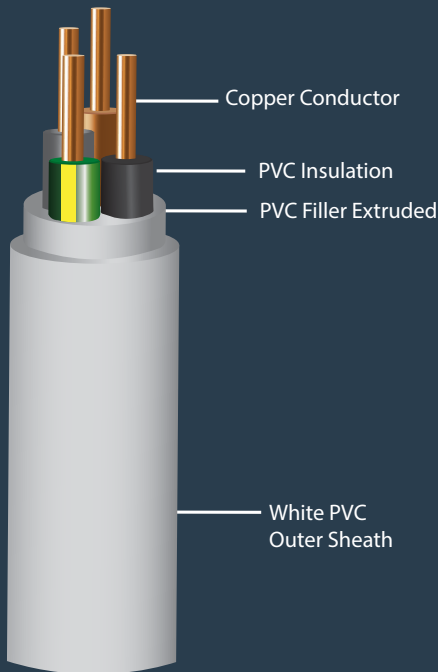

Special Features on Request

- Retardant Flame Non Category

Note

Conductor Shape

1.5 - 10 mm² supplied in solid (re) or non compacted circular stranded (rm) conductor shape
16 - 35 mm² supplied in non compacted circular stranded (rm) conductor shape

Standard Packing

15 - 2.5 mm² supplied in coil @ 100 meters or in wooden drum @ 1000/ 2000 meters
4 - 35 mm² supplied in wooden drum 1000 meters
Length Tolerance per drum ± 2%

Construction Data

Nominal Cross Section Area	Overall Diameter	Cable Weight
	approx	approx
mm ²	mm	kg/km
1.5	10.5	165
2.5	11.5	225
4	13.0	315
6	14.5	410
10	18.0	645
16	22.0	1,015
25	27.5	1,560
35	30.5	2,010

Application:

For building wire installed in conduit in dry location and interconnecting in switch board and control panel, inherently flame retardant in compliance with IEC 60332 - 1

Electrical Data

Nom Cross Section Area mm ²	Conductor		insulation	inductance	Current - Carrying Capacity at 30°C	Short Circuit current at 1 second Max. (kA)
	DC Resistance at 20°C Max (Ω/km)	AC Resistance at 70°C Max (Ω/km)	Insulation Resistance at 70°C Min. (M.Ω.km)	(mH/km)	in Air Max. (A)	
1.5	12.1	14.478	0.0100	0.335	19	0.17
2.5	7.41	8.866	0.0900	0.325	25	0.29
4	4.61	5.516	0.0077	0.297	34	0.45
6	3.08	3.685	0.0065	0.290	44	0.69
10	1.83	2.190	0.0065	0.287	61	1.15
16	1.15	1.376	0.0052	0.272	82	1.84
25	0.727	0.870	0.0050	0.270	108	2.88
35	0.524	0.627	0.0044	0.261	134	4.03

* Further information about rating factor for certain cable arrangement can be found on supplementary technical information

NYM 5 x (1.5 - 35) mm² 300/ 500 V CU/PVC/PVC

(Copper Conductor, PVC Insulated, PVC Sheathed)
Standard Specification : SPLN 42 - 2, SNI 04 - 6629.4 & IEC 60227 - 3

Construction Data

Nominal Cross Section Area	Overall Diameter	Cable Weight
	approx	approx
mm ²	mm	kg/km
1.5	11.0	195
2.5	12.5	270
4	15.0	395
6	16.0	510
10	19.5	800
16	24.0	1,265
25	30.0	1,910
35	33.5	2,510

Special Features on Request

- Retardant Flame Non Category

Note

Conductor Shape

1.5 - 10 mm² supplied in solid (re) or non compacted circular stranded (rm) conductor shape
16 - 35 mm² supplied in non compacted circular stranded (rm) conductor shape

Standard Packing

1.5 - 4 mm² supplied in coil @100 meters or in wooden drum @1000 / 2000 meters
16 - 35mm² supplied in wooden drum on 1000 meters
Length Tolerance per drum ± 2%



VOKSEL KABEL

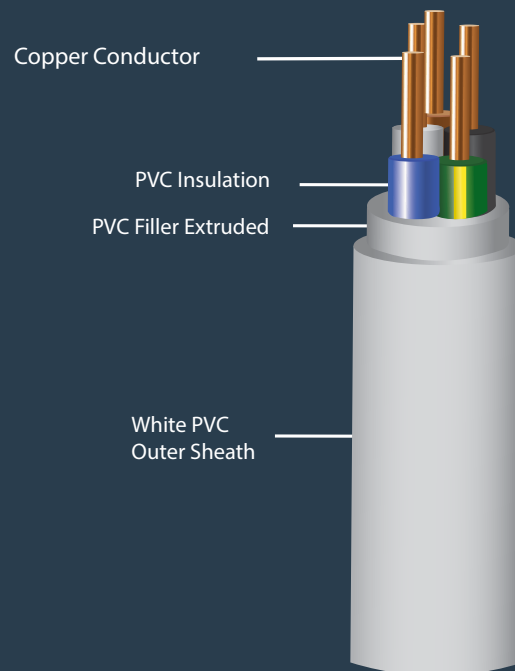

Application:

For building wire installed in conduit in dry location and interwiring in switch board and control panel, inherently flame retardant in compliance with IEC 60332 - 1

Electrical Data

Nom Cross Section Area mm ²	Conductor		insulation	inductance	Current - Carrying Capacity at 30°C	Short Circuit current at 1 second Max. (kA)
	DC Resistance at 20°C Max (Ω/km)	AC Resistance at 70°C Max (Ω/km)	Insulation Resistance at 70°C Min. (M.Ω.km)	(mH/km)	in Air Max. (A)	
1.5	12.1	14.478	0.0100	0.335	19	0.17
2.5	7.41	8.866	0.0900	0.325	25	0.29
4	4.61	5.516	0.0077	0.297	34	0.45
6	3.08	3.685	0.0065	0.290	44	0.69
10	1.83	2.190	0.0065	0.287	61	1.15
16	1.15	1.376	0.0052	0.272	82	1.84
25	0.727	0.870	0.0050	0.270	108	2.88
35	0.524	0.627	0.0044	0.261	134	4.03

* Further information about rating factor for certain cable arrangement can be found on supplementary technical information



VOKSEL KABEL

NYN 1 x (1.5 - 500) mm² 0.6/1 kV Cu/PVC/PVC

(Copper Conductor, PVC Insulated, PVC Sheathed)
Standard Specification : SPLN D3.010-2:2014, SNI IEC 60502-1

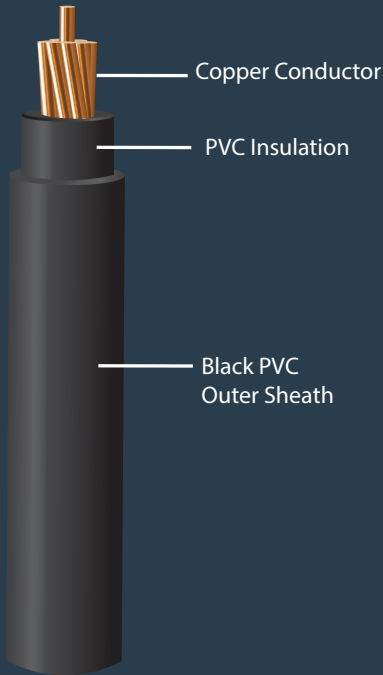

Special Features on Request

- Oil Resistance
- UV Resistance
- Retardant Flame Cat A, B, C
- Retardant Flame Non Category
- Heat Resistance
- Anti Termite
- Anti Rodent
- Low Smoke Zero Halogen

Note

Conductor Shape

1.5 - 10 mm² supplied in solid (re) or non compacted circular stranded (rm) conductor shape
16 mm² supplied in non compacted circular stranded (rm) conductor shape
25 - 500 mm² supplied in non compacted circular stranded (rm) or compacted circular stranded (cm) conductor shape

Standard Packing

1.5 - 10 mm² supplied in coil @100 meters
16 - 300 mm² supplied in wooden drum @1000 meters
400 - 500 mm² supplied in wooden drum on available length
Length Tolerance per drum ± 2%

Application:

Power cable: Indoors, cable trunking, outdoors and buried in the ground, for power stations, industry and switchgear as well as for urban supply networks. if mechanical damage is unlikely.

Construction Data

Nominal Cross Section Area mm ²	Overall Diameter	Cable Weight
	approx mm	approx kg/km
1.5	6.0	53
2.5	6.5	65
4	7.5	91
6	8.0	115
10	9.0	160
16	10.0	225
25	12.0	330
35	13.0	430
50	14.5	575
70	16.5	785
95	19.0	1,070
120	20.5	1,320
150	23.0	1,610
185	25.0	1,990
240	28.5	2,585
300	31.5	3,220
400	35.0	4,085
500	39.0	5,160

Electrical Data

Nom Cross Section Area mm ²	Conductor		Insulation Resistance at 70°C Max (M.Ω/km)	Inductance (mH/km)	Current - Carrying Capacity at 30°C		Short Circuit current at 1 second Max. (kA)
	DC Resistance at 20°C Max (Ω/km)	AC Resistance at 70°C Max (Ω/km)			in Air Max. (A)	in Ground Max. (A)	
1.5	12.1	14.478	50	0.427	26	33	0.17
2.5	7.41	8.866	50	0.423	35	45	0.29
4	4.61	5.516	50	0.421	46	58	0.46
6	3.08	3.685	50	0.395	58	74	0.69
10	1.83	2.190	50	0.367	80	98	1.15
16	1.15	1.376	40	0.341	105	129	1.84
25	0.727	0.870	40	0.332	140	169	2.88
35	0.524	0.627	40	0.316	175	210	4.03
50	0.387	0.464	30	0.295	215	250	5.75
70	0.268	0.321	30	0.284	270	310	8.05
95	0.193	0.232	30	0.280	335	375	10.93
120	0.153	0.184	30	0.268	390	425	13.80
150	0.124	0.150	20	0.271	445	480	17.25
185	0.0991	0.121	20	0.264	510	550	21.28
240	0.0754	0.093	20	0.261	620	640	27.60
300	0.0601	0.075	20	0.259	710	730	34.50
400	0.0470	0.061	20	0.255	850	855	41.12
500	0.0366	0.049	20	0.252	1000	990	51.40

* Further information about rating factor for certain cable arrangement can be found on supplementary technical information

NYY 2 x (1.5 - 400) mm² 0.6/1 kV Cu/PVC/PVC

(Copper Conductor,PVC Insulated, PVC Sheathed)
Standard Specification : SPLN 43-6, SNI 60502-1, IEC 60502-1



Construction Data

Nominal Cross Section Area	Overall Diameter	Cable Weight
	approx	approx
mm ²	mm	kg/km
1.5	12.5	200
2.5	13.0	240
4	15.0	330
6	16.0	396
10	18.0	530
16	20.0	715
25	24.5	1,025
35	26.5	1,300
50	30.5	1,725
70	34.5	2,345
95	40.5	3,155
120	44.0	3,845
150	48.0	4,720
185	53.0	5,820
240	60.0	7,565
300	66.0	9,335

Special Features on Request

- Oil Resistance
- UV Resistance
- Retardant Flame Cat A, B, C
- Retardant Flame Non Category
- Heat Resistance
- Anti Termite
- Anti Rodent
- Low Smoke Zero Halogen

Note

Conductor Shape

1.5 - 10 mm² supplied in solid (re) or non compacted circular stranded (rm) conductor shape

16 sqmm supplied in non compacted circular stranded (rm) conductor shape

25 - 400 mm² supplied in non compacted circular stranded (rm) or compacted circular stranded (cm) conductor shape

Standard Packing

1.5 - 120 mm² supplied in wooden drum @1000 meters

150 - 300 mm² supplied in wooden drum on available length
Length Tolerance per drum ± 2%

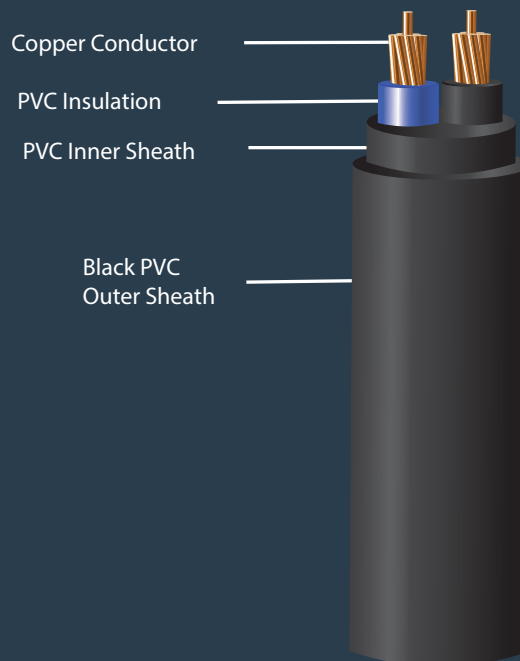

Application:

Power cable: Indoors, cable trunking, outdoors and buried in the ground, for power stations, industry and switchgear as well as for urban supply networks. If mechanical damage is unlikely.

Electrical Data

Nom Cross Section Area mm ²	Conductor		Insulation	Inductance (mH/km)	Current - Carrying Capacity at 30°C		Short Circuit current at 1 second Max. (kA)
	DC Resistance at 20°C Max (Ω/km)	AC Resistance at 70°C Max (Ω/km)	Insulation Resistance at 70°C Max (M.Ω/km)		in Air Max. (A)	in Ground Max. (A)	
1.5	12.1	14.478	50	0.349	21	27	0.17
2.5	7.41	8.866	50	0.325	29	36	0.29
4	4.61	5.516	50	0.324	38	47	0.46
6	3.08	3.685	50	0.307	48	59	0.69
10	1.83	2.190	50	0.287	66	78	1.15
16	1.15	1.376	40	0.272	90	102	1.84
25	0.727	0.870	40	0.270	120	134	2.88
35	0.524	0.627	40	0.261	150	160	4.03
50	0.387	0.464	30	0.252	180	187	5.75
70	0.268	0.321	30	0.243	230	230	8.05
95	0.193	0.232	30	0.242	275	280	10.93
120	0.153	0.184	30	0.235	320	320	13.80
150	0.124	0.150	20	0.235	375	355	17.25
185	0.0991	0.121	20	0.234	430	409	21.28
240	0.0754	0.093	20	0.231	510	472	27.60
300	0.0601	0.075	20	0.230	590	525	34.50

* Further information about rating factor for certain cable arrangement can be found on supplementary technical information

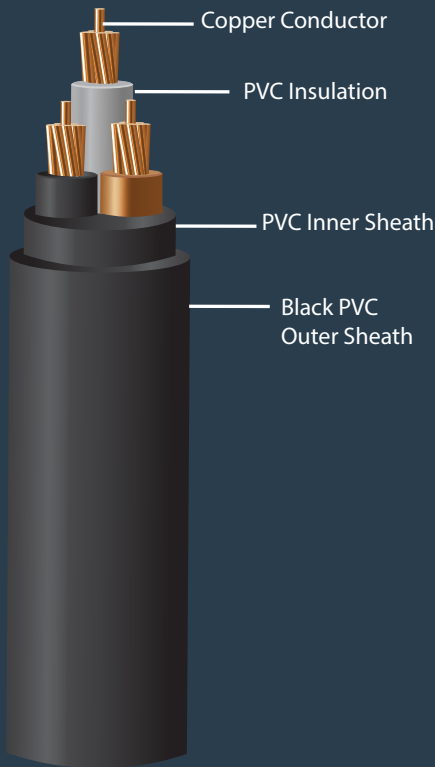

Special Features on Request

- Oil Resistance
- UV Resistance
- Retardant Flame Cat A, B, C
- Retardant Flame Non Category
- Heat Resistance
- Anti Termite
- Anti Rodent
- Low Smoke Zero Halogen

Note

Conductor Shape

1.5 - 10 mm² supplied in solid (re) or non compacted circular stranded (rm) conductor shape
16 mm² supplied in non compacted circular stranded (rm) conductor shape
25 - 400 mm² supplied in non compacted circular stranded (rm) or compacted circular stranded (cm) conductor shape

Standard Packing

1.5 - 95 mm² supplied in wooden drum @1000 meters
120 - 400 mm² supplied in wooden drum on available length
Length Tolerance per drum ± 2%

Application:

Power cable: Indoors, cable trunking, outdoors and buried in the ground, for power stations, industry and switchgear as well as for urban supply networks. if mechanical damage is unlikely.

Construction Data

Nominal Cross Section Area	Overall Diameter	Cable Weight
	approx	approx
mm ²	mm	kg/km
1.5	13.0	224
2.5	14.0	272
4	16.0	380
6	17.0	465
10	19.0	640
16	21.0	875
25	26.0	1,275
35	28.0	1,630
50	32.5	2,215
70	36.5	2,985
95	43.0	4,035
120	47.0	4,995
150	51.5	6,070
185	57.0	7,550
240	64.0	9,755
300	70.5	12,075
400	78.5	15,330

Electrical Data

Conductor			Insulation	Inductance	Current - Carrying Capacity at 30°C		Short Circuit current at 1 second Max. (kA)
Nom Cross Section Area mm ²	DC Resistance at 20°C Max (Ω/km)	AC Resistance at 70°C Max (Ω/km)	Insulation Resistance at 70°C Max (M.Ω/km)	(mH/km)	in Air Max. (A)	in Ground Max. (A)	
1.5	12.1	14.478	50	0.349	18	24	0.17
2.5	7.41	8.866	50	0.325	25	32	0.29
4	4.61	5.516	50	0.324	34	41	0.46
6	3.08	3.685	50	0.307	44	52	0.69
10	1.83	2.190	50	0.287	60	69	1.15
16	1.15	1.376	40	0.272	80	89	1.84
25	0.727	0.870	40	0.270	105	116	2.88
35	0.524	0.627	40	0.261	130	138	4.03
50	0.387	0.464	30	0.252	160	165	5.75
70	0.268	0.321	30	0.243	200	205	8.05
95	0.193	0.232	30	0.242	245	145	10.93
120	0.153	0.184	30	0.235	285	285	13.80
150	0.124	0.150	20	0.235	325	315	17.25
185	0.0991	0.121	20	0.234	370	355	21.28
240	0.0754	0.093	20	0.231	435	415	27.60
300	0.0601	0.075	20	0.230	500	465	34.50
400	0.0470	0.060	20	0.229	600	535	41.12

* Further information about rating factor for certain cable arrangement can be found on supplementary technical information

NYY 4 x (1.5 - 500) mm² 0.6/1 kV Cu/PVC/PVC

(Copper Conductor, PVC Insulated, PVC Sheathed)
Standard Specification : SPLN 43-6, SNI 60502-1, IEC 60502-1



Construction Data

Nominal Cross Section Area	Overall Diameter	Cable Weight
	approx mm	approx kg/km
mm ²		
1.5	13.5	260
2.5	14.5	320
4	17.0	450
6	18.0	560
10	20.5	775
16	23.0	1,075
25	28.0	1,585
35	31.0	2,050
50	33.0	2,675
70	37.0	3,635
95	44.0	4,955
120	47.0	6,105
150	52.5	7,475
185	58.0	9,275
240	64.0	11,940
300	70.0	14,780
400	79.5	18,920

Special Features on Request

- Oil Resistance
- UV Resistance
- Retardant Flame Cat A, B, C
- Retardant Flame Non Category
- Heat Resistance
- Anti Termite
- Anti Rodent
- Low Smoke Zero Halogen

Note

Conductor Shape

1.5 - 10 mm² supplied in solid (re) or non compacted circular stranded (rm) conductor shape
16 sqmm supplied in non compacted circular stranded (rm) conductor shape
25 - 35 mm² supplied in non compacted circular stranded (rm) or compacted circular stranded (cm) conductor shape
50 - 400 mm² supplied in non compacted circular stranded (rm) or compacted circular stranded (cm) or sector shaped stranded (sm) conductor

Standard Packing

1.5 - 70 mm² supplied in wooden drum @1000 meters
95 - 400 mm² supplied in wooden drum on available length
Length Tolerance per drum ± 2%

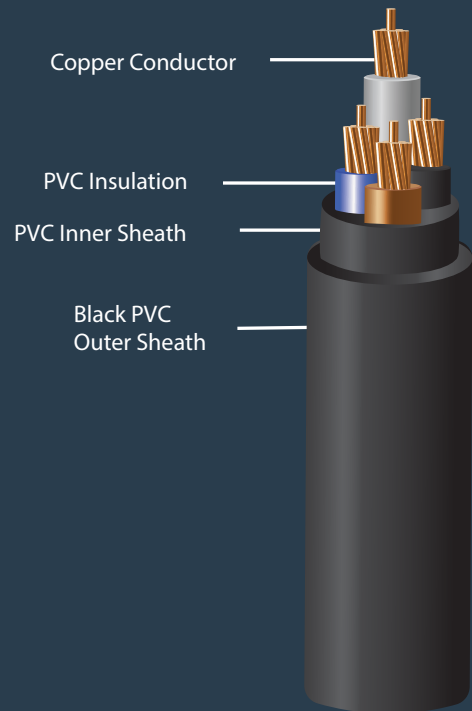

Application:

Power cable: Indoors, cable trunking, outdoors and buried in the ground, for power stations, industry and switchgear as well as for urban supply networks. if mechanical damage is unlikely.

Electrical Data

Nom Cross Section Area mm ²	Conductor		Insulation	Inductance (mH/km)	Current - Carrying Capacity at 30°C		Short Circuit current at 1 second Max. (kA)
	DC Resistance at 20°C Max (Ω/km)	AC Resistance at 70°C Max (Ω/km)	Insulation Resistance at 70°C Max (M.Ω/km)		in Air Max. (A)	in Ground Max. (A)	
1.5	12.1	14.478	50	0.349	18	24	0.17
2.5	7.41	8.866	50	0.325	25	32	0.29
4	4.61	5.516	50	0.324	34	41	0.46
6	3.08	3.685	50	0.307	44	52	0.69
10	1.83	2.190	50	0.287	60	69	1.15
16	1.15	1.376	40	0.272	80	89	1.84
25	0.727	0.870	40	0.270	105	116	2.88
35	0.524	0.627	40	0.261	130	138	4.03
50	0.387	0.464	30	0.259	160	165	5.75
70	0.268	0.321	30	0.249	200	205	8.05
95	0.193	0.232	30	0.247	245	245	10.93
120	0.153	0.184	30	0.240	285	280	13.80
150	0.124	0.150	20	0.240	325	315	17.25
185	0.0991	0.121	20	0.239	370	355	21.28
240	0.0754	0.093	20	0.237	435	415	27.60
300	0.0601	0.075	20	0.236	500	465	34.50
400	0.0470	0.060	20	0.234	600	535	41.12

* Further information about rating factor for certain cable arrangement can be found on supplementary technical information



VOKSEL KABEL

NYYHY 2 x (0.75 - 10) mm² 450 /750 V Cu-Flex/PVC/PVC

(Copper-Flexible Conductor Class 5, PVC Insulated, PVC Sheathed)
Standard Specification : IEC 60227

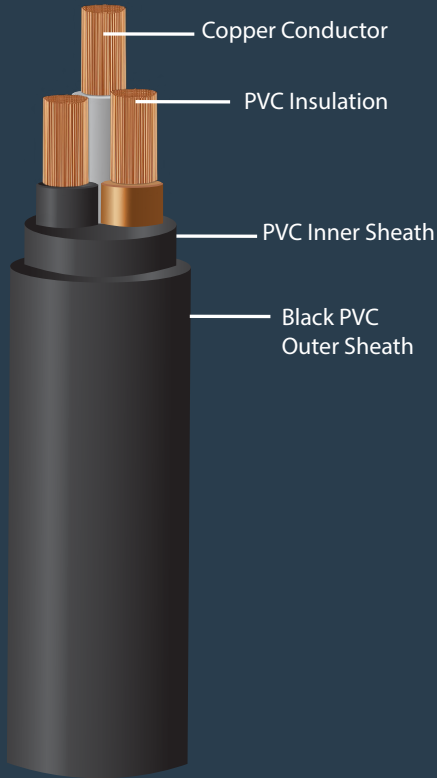

Special Features on Request

- Retardant Flame Non Category

Note

Conductor Shape

Flexible of annealed copper wires (Class.5)

Standard Packing

1.5 - 2.5 sqmm supplied in coil @ 100 meters or in wooden drum @ 1000/2000 meters
4 - 35 sqmm supplied in wooden drum @ 1000 meters
Length Tolerance per drum ± 2%

Construction Data

Nominal Cross Section Area mm ²	Overall Diameter	Cable Weight
	approx mm	approx kg/km
0.75	6.3	55
1.0	6.6	64
1.5	7.5	85
2.5	9.3	134
4	11.3	195
6	15.0	435
10	18.0	630

Application:

Power cable: Indoors, cable trunking, outdoors and buried in the ground, for power stations, industry and switchgear as well as for urban supply networks. if mechanical damage is unlikely.

Electrical Data

Nom Cross Section Area mm ²	Conductor		Insulation	inductance (mH/km)	Current - Carrying Capacity at 30°C in Air Max. (A)	Short Circuit current at 1 second Max. (kA)
	DC Resistance at 20°C Max (Ω/km)	AC Resistance at 70°C Max (Ω/km)	Insulation Resistance at 70°C Max (M.Ω/km)			
0.75	26.0	31.109	0.011	0.554	6	00.09
1.0	19.50	23.332	0.010	0.541	10	0.12
1.5	13.30	15.913	0.010	0.535	15	0.17
2.5	7.98	9.548	0.009	0.516	20	0.29
4	4.95	5.923	0.0077	0.490	25	0.46
6	3.30	3.948	0.0065	0.470	33	0.69
10	1.91	2.285	0.0065	0.470	45	1.15

* Further information about rating factor for certain cable arrangement can be found on supplementary technical information

NYY 4 x (1.5 - 500) mm² 0.6/1 kV Cu/PVC/PVC

(Copper Conductor, PVC Insulated, PVC Sheathed)
Standard Specification : SPLN 43-6, SNI 60502-1, IEC 60502-1



Construction Data

Nominal Cross Section Area mm ²	Overall Diameter	Cable Weight
	approx mm	approx kg/km
1.5	13.5	260
2.5	14.5	320
4	17.0	450
6	18.0	560
10	20.5	775
16	23.0	1,075
25	28.0	1,585
35	31.0	2,050
50	33.0	2,675
70	37.0	3,635
95	44.0	4,955
120	47.0	6,105
150	52.5	7,475
185	58.0	9,275
240	64.0	11,940
300	70.0	14,780
400	79.5	18,920

Special Features on Request

- Oil Resistance
- UV Resistance
- Retardant Flame Cat A, B, C
- Retardant Flame Non Category
- Heat Resistance
- Anti Termite
- Anti Rodent
- Low Smoke Zero Halogen

Note

Conductor Shape

1.5 - 10 mm² supplied in solid (re) or non compacted circular stranded (rm) conductor shape
 16 sqmm supplied in non compacted circular stranded (rm) conductor shape
 25 - 35 mm² supplied in non compacted circular stranded (rm) or compacted circular stranded (cm) conductor shape
 50 - 400 mm² supplied in non compacted circular stranded (rm) or compacted circular stranded (cm) or sector shaped stranded (sm) conductor

Standard Packing

1.5 - 70 mm² supplied in wooden drum @1000 meters
 95 - 400 mm² supplied in wooden drum on available length
 Length Tolerance per drum ± 2%

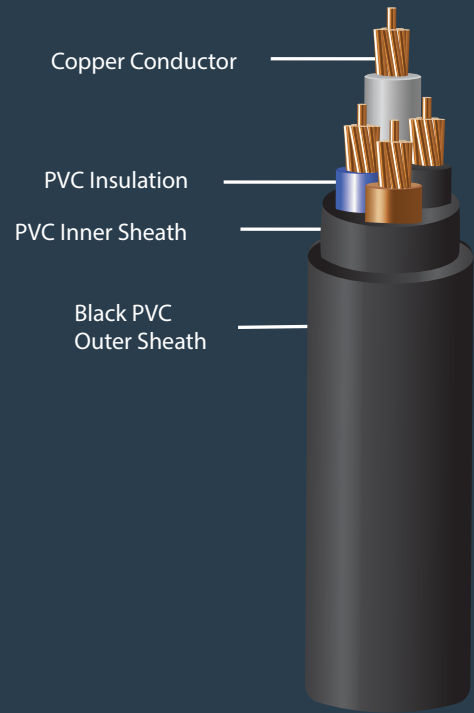

Application:

Power cable: Indoors, cable trunking, outdoors and buried in the ground, for power stations, industry and switchgear as well as for urban supply networks. if mechanical damage is unlikely.

Electrical Data

Nom Section Area mm ²	Conductor		Insulation	inductance (mH/km)	Current - Carrying Capacity at 30°C		Short Circuit current at 1 second Max. (kA)
	DC Resistance at 20°C Max (Ω/km)	AC Resistance at 70°C Max (Ω/km)	Insulation Resistance at 70°C Max (M.Ω/km)		in Air Max. (A)	in Ground Max. (A)	
1.5	12.1	14.478	50	0.349	18	24	0.17
2.5	7.41	8.866	50	0.325	25	32	0.29
4	4.61	5.516	50	0.324	34	41	0.46
6	3.08	3.685	50	0.307	44	52	0.69
10	1.83	2.190	50	0.287	60	69	1.15
16	1.15	1.376	40	0.272	80	89	1.84
25	0.727	0.870	40	0.270	105	116	2.88
35	0.524	0.627	40	0.261	130	138	4.03
50	0.387	0.464	30	0.259	160	165	5.75
70	0.268	0.321	30	0.249	200	205	8.05
95	0.193	0.232	30	0.247	245	245	10.93
120	0.153	0.184	30	0.240	285	280	13.80
150	0.124	0.150	20	0.240	325	315	17.25
185	0.0991	0.121	20	0.239	370	355	21.28
240	0.0754	0.093	20	0.237	435	415	27.60
300	0.0601	0.075	20	0.236	500	465	34.50
400	0.0470	0.060	20	0.234	600	535	41.12

* Further information about rating factor for certain cable arrangement can be found on supplementary technical information

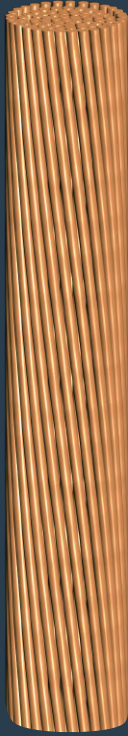

Features

The conductors are applied for grounding system

Construction Conductor

Seven or more copper wires the same nominal diameter are twisted together in concentric layers.
 When conductor consists of more than one layers are twisted in opposite directions which is defined as right-hand lay (Z) or left-hand lay (S)

Standard Packing

6 - 10 mm² supplied in coil @100 meters
 16 - 500 mm² supplied in wooden drum on @1000 meters
 Length Tolerance per drum ± 2%

Application:

The bare copper conductor are used as ground conductor, uninsulated hook up wires and jumpers.

Electrical Data

Nominal cross section	Calculated Tensile Strength	DC Resistance at 20 °C	Short Circuit Capacity (1 second)
mm ²	n/mm ²	Ω/km	kA
6	2,130	2.8961	1.21
10	3,271	1.8545	2.02
10	3,587	1.8160	2.02
16	5,640	1,1452	3.24
25	8,510	0.7504	5.06
35	11,957	0.5296	7.08
50	17,115	0.3781	10.12
70	23,098	0.2778	14.17
95	32,456	0.1961	19.23
120	40,479	01563	24.29
150	51,490	0.1243	30.36
185	63,205	0.1007	37.45
240	84,889	0.0754	48.58
300	104,202	0.0611	60.72
400	138,049	0.0457	80.96
500	171,443	0.0366	101.20

Construction Data

Nom. cross section		No. of wire/ diameter	Approx. overall diameter	Approx. net weight of conductor
Nominal Size	Actual Size			
mm ²	mm ²	n/m	mm	kg/km
6	6.16	1/2.80	2.8	55
10	9.62	1/3.50	3.5	86
10	10.02	7/1.35	4.05	92
16	15.89	7/1.70	5.1	145
25	24.25	7/2.10	6.3	220
35	34.36	7/2.50	7.5	315
50	48.36	19/1.80	9.0	440
70	65.82	19/2.10	10.5	600
95	93.27	19/2.50	12.5	850
120	227.00	19/2.80	14.0	1,075
150	147.10	37/2.25	15.7	1,340
185	181.60	37/2.50	17.5	1,660
240	242.50	61/2.25	20.2	2,250
300	299.40	61/2.50	22.5	2,750
400	400.10	61/2.89	26.0	3,636
500	499.10	61/3.23	29.1	4,542

* Further information about rating factor for certain cable arrangement can be found on supplementary technical information

BCC - H

Bare Copper Conductor Hard

Standard Specification : SPLN 41 - 5 : 1981 & SNI 04 - 3894 : 1995



VOKSEL KABEL

Electrical Data

Nominal cross section	Calculated Tensile Strength	DC Resistance at 20 °C	Short Circuit Capacity (1 second)
mm ²	n/mm ²	Ω/km	kA
6	2,493	2.8994	1.21
10	3,809	1.8565	2.02
10	4,158	1.8181	2.02
16	6,593	1.1465	3.24
25	9,940	0.7512	5.06
35	13,916	0.5302	7.08
50	19,823	0.3785	10.12
70	26,981	0.2781	14.17
95	37,772	0.1963	19.23
120	47,382	0.1565	24.29
150	61,317	0.1244	30.36
185	73,557	0.1008	37.45
240	99,441	0.0755	48.58
300	121,270	0.0611	60.72
400	162,058	0.0458	80.96
500	199,933	0.0367	101.20

Features

The conductors are applied for grounding system

Construction Conductor

Seven or more copper wires the same nominal diameter are twisted together in concentric layers.

When conductor consists of more than one layers are twisted in opposite directions which is defined as right-hand lay (Z) or left-hand lay (S)

Standard Packing

6 - 10 mm² supplied in coil @100 meters

16 - 500 mm² supplied in wooden drum on @1000 meters

Length Tolerance per drum ± 2%

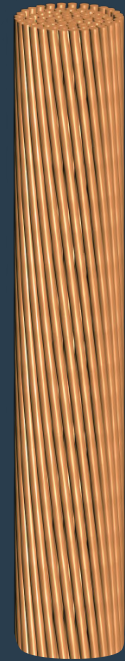

Application:

The bare copper conductor are used as ground conductor, uninsulated hook up wires and jumpers.

Construction Data

Nom. cross section		No. of wire/ diameter	Approx. overall diameter	Approx. net weight of conductor
Nominal Size	Actual Size			
mm ²	mm ²	n/m	mm	kg/km
6	6.16	1/2.80	2.8	55
10	9.62	1/3.50	3.5	86
10	10.02	7/1.35	4.05	92
16	15.89	7/1.70	5.1	145
25	24.25	7/2.10	6.3	220
35	34.36	7/2.50	7.5	315
50	48.36	19/1.80	9.0	440
70	65.82	19/2.10	10.5	600
95	93.27	19/2.50	12.5	850
120	227.00	19/2.80	14.0	1,075
150	147.10	37/2.25	15.7	1,340
185	181.60	37/2.50	17.5	1,660
240	242.50	61/2.25	20.2	2,250
300	299.40	61/2.50	22.5	2,750
400	400.10	61/2.89	26.0	3,636
500	499.10	61/3.23	29.1	4,542

* Further information about rating factor for certain cable arrangement can be found on supplementary technical information

Product Safety Information

Read all safety information before using Power Cable products (Low Voltage, Medium Voltage, High Voltage & Market Cables) to ensure safe and proper utilization.



COMPOSITION	
CABLE	PACKAGING
<ol style="list-style-type: none"> 1. Copper Rod 2. Copper Tape 3. Aluminum 4. Water Blocking Powder 5. Water Blocking Tape 6. Cross-linked polyethylene (XLPE) 7. Poly Ethylene (PE) 8. Binder Tape 9. Polyvinyl Chloride (PVC) 10. Galvanized Steel 	<ol style="list-style-type: none"> 1. Semipermanent Drum 2. Wooden Drum 3. Nail 4. Steel plate 5. Paint

CABLE UTILIZATION HAZARDS

- Danger of electric currents when installing / connecting cable products (electrocuted high voltage currents).
- Be careful when stripping the cable product using the cutter.
- Be careful threatened by "double steel tape" when stripping cable products.
- Be careful threatened by "cooper wire" when stripping cable products.
- Be careful threatened by "tape screen" when stripping cable products.
- Be careful when cutting the cable product using steel scissors.



PACKAGING HAZARDS

- Be careful with nails which can puncture your hands / feet when closing & opening the drum.
- Be careful when opening the "clamp plate" of the product in the form of drum (wounded / slashed).
- Be careful when stripping the cable product using the cutter (wounded / slashed).



TRANSPORT HAZARDS

- Be careful during the process of loading and unloading the drum from / to the vehicle, because it can cause a potential danger of being pinched and crushed on the hand / foot.
- Do not drop the drum from the vehicle directly. Use a forklift when loading & unloading.
- Do not push the drum on the opposite direct of the drum arrow marked.
- Push befitting the arrow indicated on the drum. When pushing the drum, the body position must be safe from the threat of danger & ask for help to push if needed.
- To prevent the drum rolling, use chops on both sides (2 chops in front & 2 chops at the back).









Building Wire



PT VOKSEL ELECTRIC Tbk.



PT Voksel Electric Tbk.

Executive Office

Menara Karya 3rd Floor, Suite D,
Jl. HR. Rasuna Said Blok X-5 Kav 1-2,
Jakarta 2950 - Indonesia
Phone : (+62 21) 5794 4622





Factory & Operational Office

Jl. Raya Narogong Km. 16,
Cileungsi, Bogor 6820 - Indonesia
Phone : (+62 21) 8230 525, 8249 1720

Customer Service

Phone : (+62 21) 8249 3329
Email : sales@voksel.co.id

Visit Us

-  VOKSELKABEL_OFFICIAL
-  VOKSEL KABEL ID
-  WWW.VOKSEL.CO.ID
-  WWW.VOKSELKABEL.COM