



MASPION



PVC PIPE & FITTING

PRODUCT CATALOGUE

12

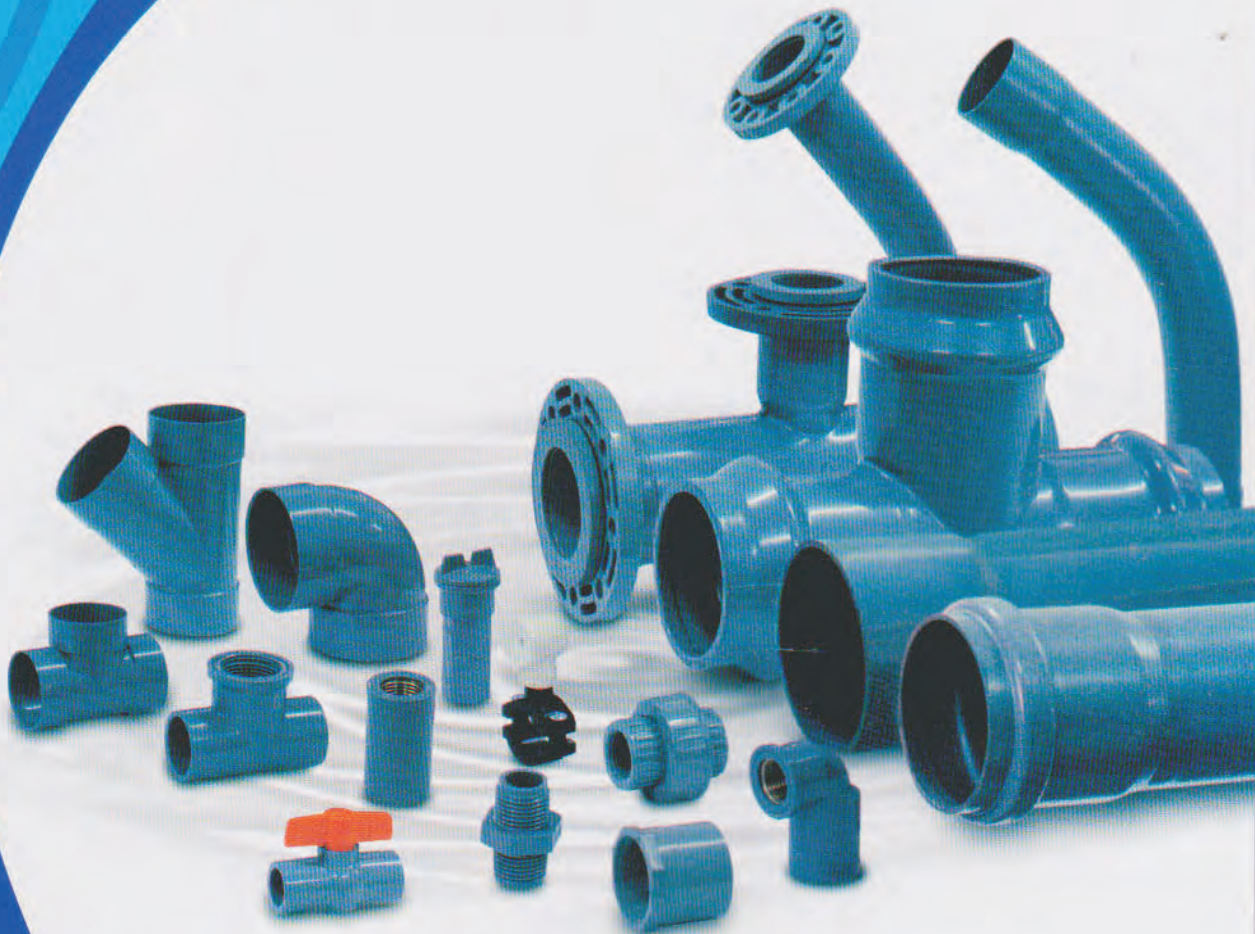

MASPION PVC PIPE

JIS STANDARD

RUBBER RING SOCKETING PIPES

SOLVENT CEMENT SOCKETING PIPES

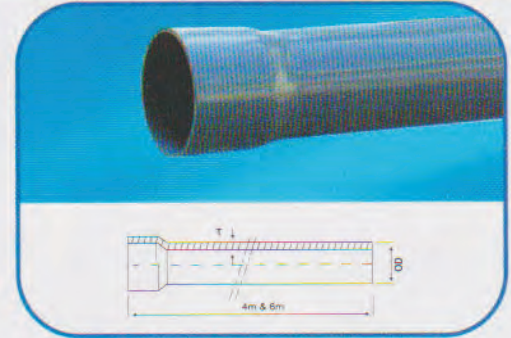
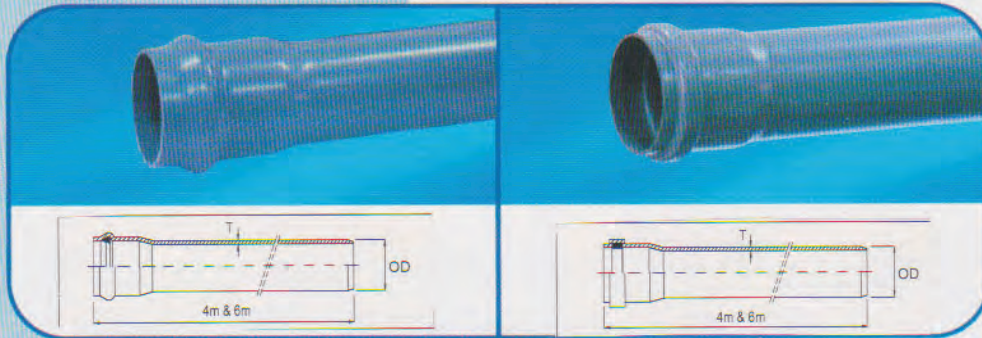

PVC PIPE MASPION STANDARD

Colour: Light Grey

NOMINAL DIAMETER		O.D	THICKNESS		O.D	THICKNESS
inch	mm		AW	D		
5/8"	-	-	-	-	17	0.8
1/2"	16	22	2.4	-	-	-
3/4"	20	26	2.5	-	22	1.1
1"	25	32	2.6	-	26	1.4
1 1/4"	30	38/42	2.7	1.65	32	1.4
1 1/2"	40	48	3.1	1.65	38	1.4
2"	50	60	3.7	1.7	60	1.4
2 1/2"	65	76	3.7	2.0	76	1.4
3"	75	89	4.5	2.5	89	1.4
4"	100	114	5.2	2.7	114	1.4
5"	125	140	6.7	3.6		
6"	150	165	7.5	3.7		
8"	200	216	9.0	5.0		
10"	250	267	10.0	7.0		
12"	300	318	12.0	8.0		
14"	350	370	14.5	9.0		
16"	400	420	16.0	10.0		
20"	500	520	-	14.0		

Colour: White

NOMINAL DIAMETER		O.D	THICKNESS		
inch	mm		AW	D	C
5/8"	-	17	-	-	0.8
1/2"	16	22	1.6	-	1.1
3/4"	20	26	1.8	-	1.4
1"	25	32	2.0	-	1.4
1 1/4"	30	42	2.2	1.3	-
1 1/2"	40	48	2.3	1.4	-
2"	50	60	2.4	1.5	1.4
2 1/2"	65	76	2.6	1.6	1.4
3"	75	89	3.2	1.7	1.4
4"	100	114	4.2	2.2	1.4
5"	125	140	5.5	2.7	
6"	150	165	6.5	3.2	
8"	200	216	7.7	4.2	
10"	250	267	9.6	5.3	
12"	300	318	11.5	6.5	

NOTE : CONNECTION WITH RUBBER RING

SPECIFICATION PVC PIPE JIS K 6741 - 1975

NOMINAL DIAMETER		OUTSIDE DIAMETER	THICKNESS (mm)	
inch	mm		CLASS V P	CLASS V U
1/2"	16	22	2.7	-
3/4"	20	26	2.7	-
1"	25	32	3.1	-
1 1/4"	30	38	3.1	-
1 1/2"	40	48	3.6	1.8
2"	50	60	4.1	1.8
2 1/2"	65	76	4.1	2.2
3"	75	89	5.5	2.7
4"	100	114	6.6	3.1
5"	125	140	7.0	4.1
6"	150	165	8.9	5.1
8"	200	216	10.3	6.5
10"	250	267	12.7	7.8
12"	300	318	15.1	9.2

MASPION PVC PIPE

SNI STANDARD

RUBBER RING SOCKETING PIPES

SOLVENT CEMENT SOCKETING PIPES

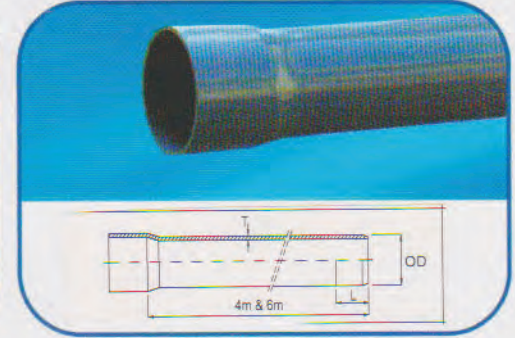
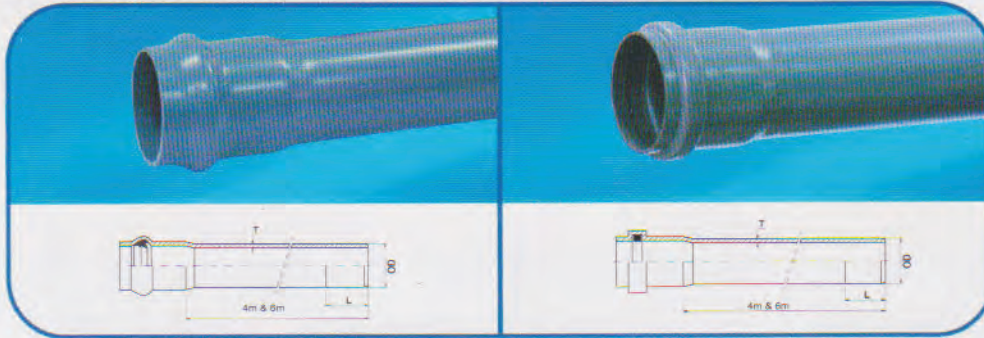

SPECIFICATION PVC PIPE SNI 06 - 0084 - 2002

ISO 4065 - 1978

NOMINAL OUTSIDE DIAMETER (N O D) (mm)	Pipe Series (S)				
	Nominal Wall Thickness (mm)				
	S - 6.3	S - 8	S - 10	S - 12.5	S - 16
16	1.5	-	-	-	-
20	1.5	-	-	-	-
25	1.9	1.5	-	-	-
32	2.4	1.9	1.6	-	-
40	3.0	2.4	1.9	1.6	1.5
50	3.7	3.0	2.4	2.0	1.6
63	4.7	3.8	3.0	2.4	2.0
75	5.5	4.5	3.6	2.9	2.3
90	6.6	5.4	4.3	3.5	2.8
110	8.2	6.6	5.3	4.2	3.4
125	9.2	7.4	6.0	4.8	3.9
140	10.3	8.3	6.7	5.4	4.3
160	11.8	9.5	7.7	6.2	4.9
200	14.7	11.9	9.6	7.7	6.2
225	16.6	13.4	10.8	8.6	6.9
250	18.4	14.8	11.9	9.6	7.7
280	20.6	16.6	13.4	10.7	8.6
315	23.2	18.7	15.0	12.1	9.7
355	26.1	21.1	16.9	13.6	10.9
400	29.4	23.7	19.1	15.3	12.3
450	-	26.7	21.5	17.2	13.8
500	-	29.6	23.9	19.1	15.3
630	-	-	30.0	24.1	19.3
710	-	-	-	27.2	21.8

NOTE : CONNECTION WITH RUBBER RING

PVC PIPE SEWAGE USED SNI 06 - 0162 - 1987

OUTSIDE DIAMETER (mm)	THICKNESS (mm)	
	CLASS A	CLASS B
40	1.8	3.2
50	1.8	3.2
63	1.8	3.2
75	1.8	3.2
90	1.8	3.2
110	2.2	3.2
125	2.5	3.2
160	3.2	4.0
200	3.9	4.9
250	4.9	6.2
315	6.2	7.7
355	7.0	8.7
400	7.8	9.8
500	9.8	12.3

**JIS K 6743 - 1979
MASPION PVC FITTINGS
PVC PIPE & FITTING**

FOR WATER PRESSURE & GENERAL PURPOSE

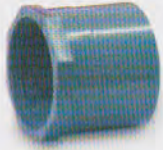

TS FAUCET SOCKET



TS VALVE SOCKET



TS FAUCET ELBOW



TS ELBOW



TS FAUCET TEE

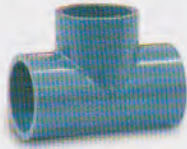

TS TEE

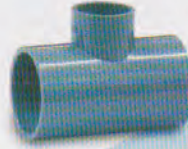

TS REDUCER TEE

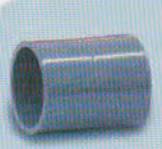

TS SOCKET

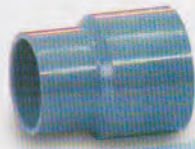

TS REDUCER SOCKET



TS FAUCET ELBOW WITH METAL INSERT



TS FAUCET SOCKET WITH METAL INSERT



DOUBLE NIPPLE



VERLOP RING



PVC FLANGE



STRAP SADDLE



PLUG

FOR DRAINAGE & VENT



DV ELBOW 90°



DV ELBOW 67° 30'



DV ELBOW 45°



DV TEE



DV TEE Y 90°



DV TEE Y 45°

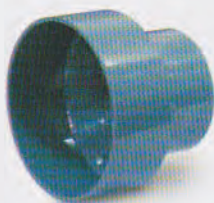

DV REDUCER SOCKET

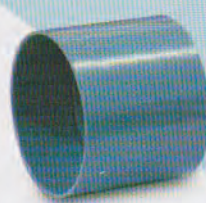

DV SOCKET



OUTLET BATH

SNI 06 0135 - 1989
MASPION PVC FITTINGS
PVC PIPE & FITTING



REDUCER RUBBER RING - SPIGOT

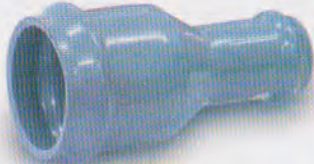

REDUCER ALL RUBBER RING



REPAIR COLLAR

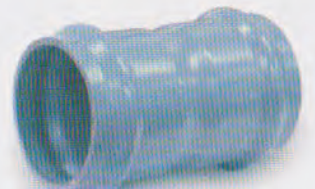

SOCKET ALL RUBBER RING



SOCKET ALL SOLVENT CEMENT

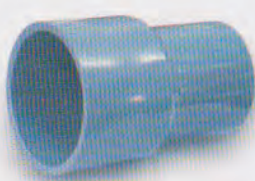

REDUCER ALL SOLVENT CEMENT



REDUCER TEE ALL RUBBER RING



TEE ALL RUBBER RING



TEE R-RING - SOLVENT CEMENT



TEE ALL FLANGE

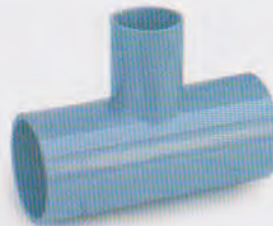

REDUCER TEE SOLVENT CEMENT



STUB FLANGE

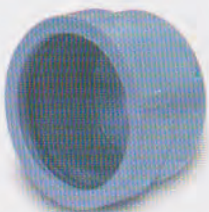

END CAP RUBBER RING

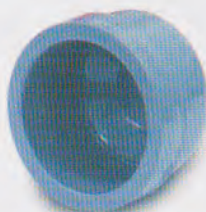

END CAP SOLVENT CEMENT

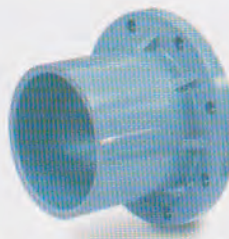

FLANGE SOCKET SOLVENT CEMENT



FLANGE SOCKET R-RING

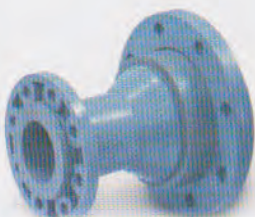

REDUCER ALL FLANGE



CLAMP SADDLE WITH FERRULE



CLAMP SADDLE



FLANGE SPIGOT TAPER CORE



FLANGE ADAPTOR TAPER CORE



PVC FLANGE

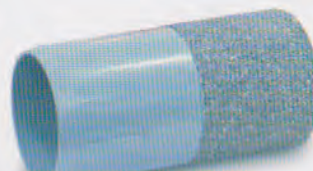

MAN HOLE SHORT PIPE

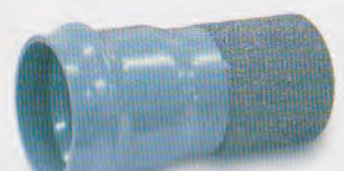

MAN HOLE PIPE JOINT

MASPION PVC FITTINGS

PVC PIPE & FITTING



NOZZLE

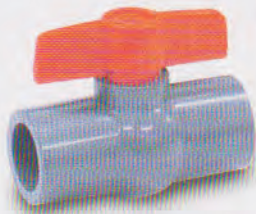

UNION BALL VALVE 1/2", 3/4", 1"



SPRAY NOZZLE Ø 1

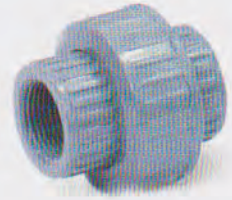

UNION 1/2", 3/4", 1"



BEND ALL RUBBER RING



BEND RUBBERING RING - SPIGOT



BEND ALL SOLVENT CEMENT



BEND ALL FLANGE

MASPION SOLVENT CEMENT



Maspion Glue and Masplas solvent cement are used for pipe, fitting and all PVC material products.

There are two kinds of solvent cement, namely quick drying type (no.80) and slow drying type (no.100). Quick drying type is used for small pipe diameter or processing in door. Slow drying type is used for pipe large diameter or processing in outdoor.

Content : 45 gram / tube
500 gram / can
1000 gram / can

Lem PVC Maspion Glue dan Masplas dipakai untuk pipa, fitting serta semua jenis produksi dari bahan PVC. Ada dua tipe lem, yaitu tipe cepat kering (no.80), lambat kering (no.100). Tipe cepat kering digunakan untuk pipa diameter kecil atau proses dalam ruangan. Sedangkan lambat kering digunakan untuk pipa diameter besar atau proses luar ruangan.

Isi : 45 gram / tube
500 gram / kaleng
1000 gram / kaleng



LUBRICANT

Maspion Lubricant is suitable for lubricating joint components. It has no deteriorating effect on the Rubber Ring joint, pipe material and non toxic.

Content : 1000 gram / can

PELUMAS

Pelumas Maspion adalah pelumas yang tepat untuk melicinkan / mempermudah penyambungan pipa yang memakai gelang karet. Pelumas ini tidak ada efek sampingan terhadap gelang karet, bahan pipa dan tidak beracun.

Isi : 1000 gram / kaleng



PT. GOLDEN PIPING INDONESIA

Jl. Pahlawan Seribu, Ruko Golden Boulevard Blok E-30 BSD City
Kota Tangerang Selatan 15320 Banten Indonesia

Telp.: +62 21 5315 6333, 5315 9333 Fax.: +62 21 5316 7333

Download File: info@depipacoin.com