

Panasonic

General Catalogue
Electrical Construction Materials
2022 - 2023



Profil Perusahaan

Sejak didirikan pada 1918, Panasonic telah melandaskan aktivitas perusahaan melalui Basic Management Objective. Melalui kegiatan bisnis kami, Panasonic memperjuangkan kemajuan dan perkembangan masyarakat dengan cara meningkatkan kesejahteraan masyarakat di berbagai penjuru dunia. Dengan menitikberatkan pada masyarakat, kami bermaksud memperkaya gaya hidup mereka sekaligus melangkah ke arah yang lebih baik bersama dengan konsumen kami.

Panasonic Electric Works Company memegang berbagai macam kegiatan bisnis. Divisi Bisnis Energy System kami menangani banyak hal, mulai dari perangkat listrik dan tombol sakelar hingga modul photovoltaic, sistem penyimpanan baterai, serta alat kendali manajemen energi. Divisi Lighting melakukan inovasi berbagai pencahayaan yang hemat energi melalui bohlam LED, armatur lampu dan alat pencahayaan lainnya. Divisi Smart Energy System berkontribusi untuk mengurangi dampak lingkungan melalui pengembangan komponen elektrokimia (fuel cell), fuel cell hidrogen dan perangkat pengukur.

Kami membantu menciptakan sebuah lingkungan dimana masyarakat di seluruh dunia dapat hidup dalam kenyamanan, di saat bersamaan meminimalisir kerusakan lingkungan. Memadukan ekologi dan kenyamanan menjadi sebuah harmoni merupakan misi kami. Kami hendak mencapai hal ini dengan menciptakan solusi residensial dan non residensial, dengan memanfaatkan produk Panasonic grup yang ekstensif dan beragam. Dengan menawarkan berbagai solusi Panasonic kepada konsumen di seluruh dunia, kami berupaya untuk berkontribusi menciptakan masyarakat yang berkelanjutan.

Panasonic — Manufaktur yang Berdedikasi Pada Kehidupan Masyarakat

Manufaktur yang sadar akan kehidupan dan tidak menyakiti manusia serta lingkungan selalu menjadi prioritas Panasonic. Patuh pada kebijakan RoHS yang berasal dari Uni Eropa, Panasonic melarang penggunaan seluruh material berbahaya yang mungkin dapat membawa dampak pada lingkungan dan manusia seperti timbal, kadmium, kromium, merkuri, dan sejenisnya. Panasonic berkontribusi menjadi manufaktur ramah lingkungan melalui sistem pengelasan yang bebas timbal, bebas kadmium dan plating yang bebas kromium.



Panasonic, Electric Works Company (Osaka, Japan)

Konsep Produk

Konsep Desain “Lima Elemen” Panasonic

Sistem terintegrasi dalam pengembangan produk kami merupakan dasar yang memungkinkan kami untuk memproduksi produk berkualitas tinggi secara konsisten. Hal ini dimulai dengan mempelajari kebutuhan masyarakat secara akurat, mengembangkan teknologi dasar yang canggih merencanakan produk, desain dan produksi, hingga mengembangkan cara-cara memasarkan produk dan kegiatan pasca penjualan.

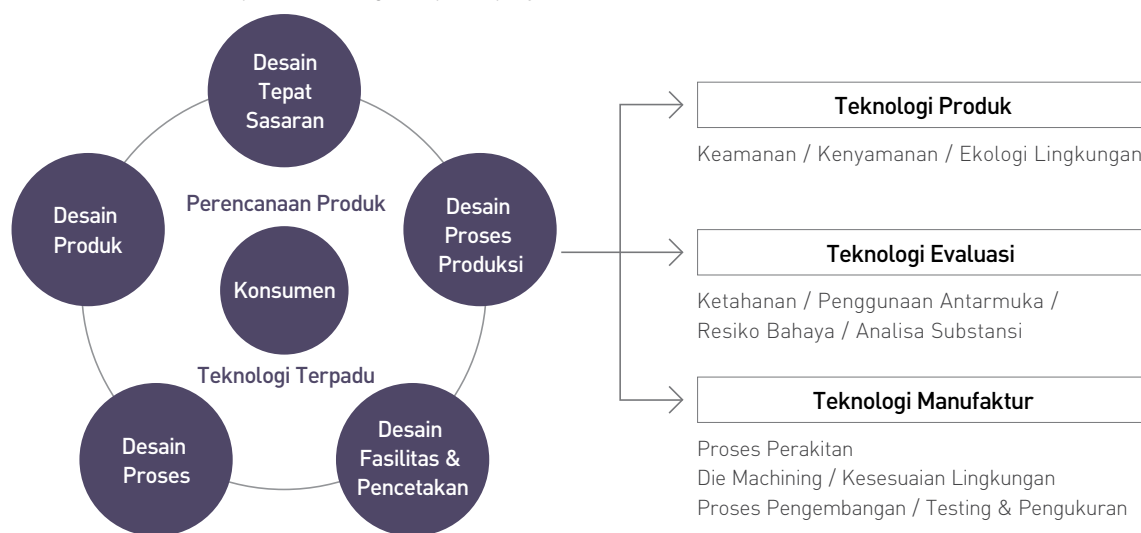

Panasonic — berkomitmen menciptakan Keamanan dan Kenyamanan bagi konsumen dalam penggunaan produk kami.

Pengenalan dan Klasifikasi Alat Listrik Panasonic Berdasarkan Struktur Terminal

Pengenalan Produk Pertama Panasonic dan Evolusi Alat Listrik Panasonic

1918 Fitting Lampu



Evolusi Seri Sakelar Panasonic

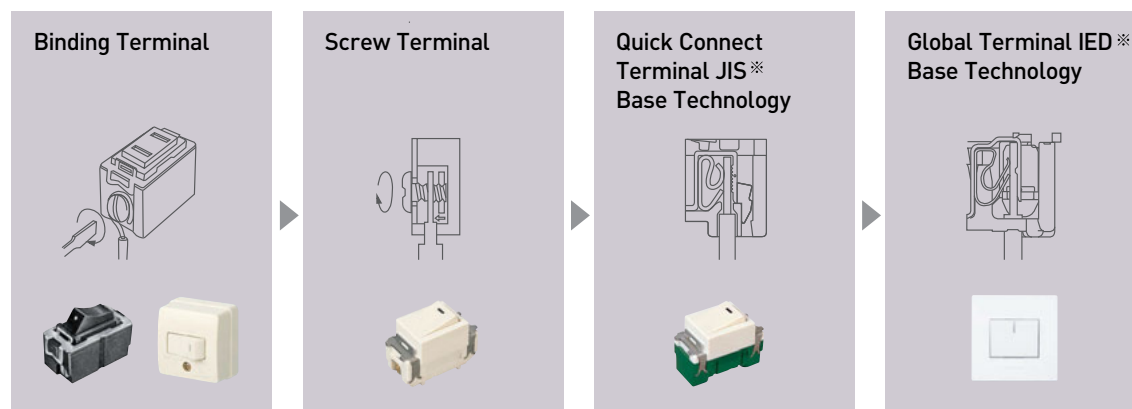

**JIS = Japanese Industrial Standards **IEC = International Electrotechnical Commission

Menuju Ke Level Selanjutnya

Panasonic telah hadir di Indonesia selama bertahun-tahun.

Sejauh ini konsumen kami telah mengapresiasi seluruh rangkaian produk Panasonic, termasuk di dalamnya adalah produk unggulan kami, sakelar dan stop kontak, yang merupakan bagian tak terpisahkan dari Panasonic Electrical Construction Materials.

Berperan penting dalam perkembangan perusahaan Panasonic sejak 1918, sakelar dan stop kontak Panasonic memiliki reputasi sebagai produk yang aman, tahan lama dan nyaman di seluruh dunia. Sejalan dengan Panasonic mengembangkan produk baru berteknologi tinggi yang disertai dengan peningkatan kemampuan manufaktur, gagasan kami mengenai keamanan dan kenyamanan pun terus berkembang.

Komitmen tanpa kompromi Panasonic memungkinkan kami untuk menawarkan tingkat kepuasan yang lebih tinggi kepada konsumen melalui berbagai macam produk kategori kami.



*Produk Orisinal Panasonic
1918
Fitting lampu*



WIRING DEVICES	P10		Stylee
	P16		FULL-COLOR WIDE SERIES
	P22		FLASIMO
	P24		MINIMAL ART
	P28		A'mode
	P32		FULL-COLOR SERIES
	P36		Acrosea
	P40		HOTEL ACCESSORIES
	P41		ALPHACUBE
	P48		FLOOR OUTLET SERIES
PASSIVE INFRARED SENSOR	P50		
AUTOMATIC TIME SWITCH	P52		

Product Positioning (Series of Wiring Devices)

Rangkaian sakelar stop kontak Panasonic memperindah penampilan ruang keluarga, kantor, area publik serta berbagai macam ruang lainnya. Berbagai pilihan sakelar dan stop kontak Panasonic, masing-masing dengan desain khas, variasi warna dan kemudahan pengoperasian yang sesuai untuk memenuhi kebutuhan instalasi.

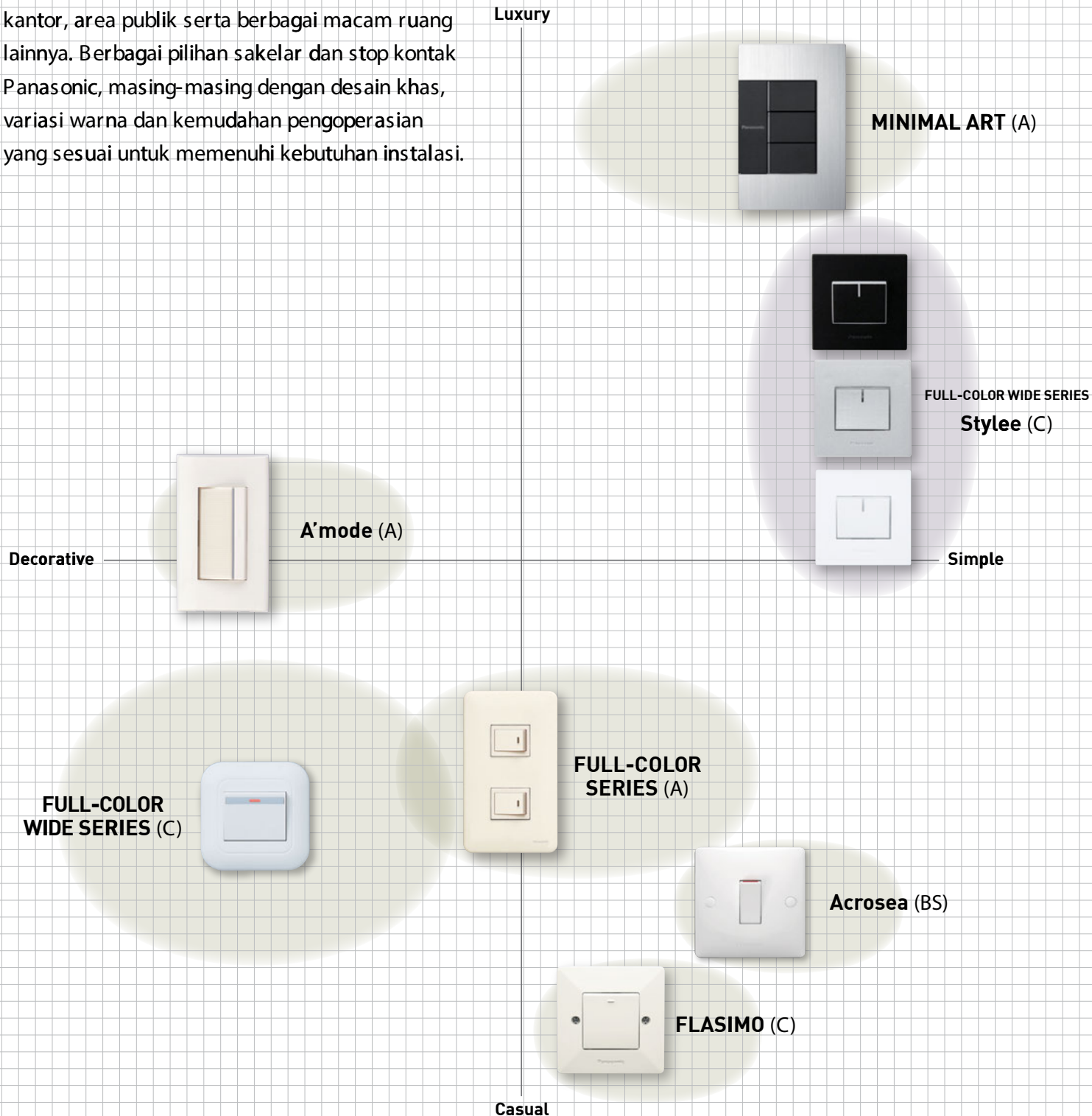

Type of Wiring Device

C*	FULL-COLOR WIDE SERIES Stylee P. 10		Gaya minimalis kontemporer dengan Teknologi masa kini. Stylee hadir dengan konsep minimalis yang didesain untuk menyatu dengan desain interior yang simple dan modern.
	FULL-COLOR WIDE SERIES P. 16		Desain tipis yang stylish. Fleksibel dengan gaya yang abadi. Wide Series memiliki desain minimalis dan tipis dengan pilihan warna dan material yang sangat fleksibel untuk segala gaya interior Anda - mulai dari gaya konservatif, modern, sederhana, hingga elegan.
	FLASIMO P. 22		Desain Flat & Simple untuk gaya modern dan ekonomis. Flasimo dengan tampilan tipis persegi memberikan gaya modern nan ekonomis.
A*	MINIMAL ART P. 24		Balutan aluminium yang premium, karya seni dengan teknologi terkini. MINIMAL ART series adalah sebuah teknologi yang dibalut dengan seni. Tampilan dan teknologinya yang memukau akan menghadirkan kesan elegan yang Anda inginkan untuk segala gaya desain interior modern dan minimalis Anda.
	A'mode P. 28		Inspirasi seni Jepang. Aura kemewahan dalam kesederhanaan. A'mode series terinspirasi dari seni Jepang yang sederhana namun memancarkan aura kemewahan. Sebuah desain elegan dengan filosofi zen yang cocok untuk interior minimalis Anda.
	FULL-COLOR SERIES P. 32		Desain sederhana dan dirancang untuk kepraktisan. Desainnya yang sederhana dengan teknologi terkini untuk kepraktisan penggunaan ruangan Anda.
BS*	Acrosea P. 36		Paduan serasi untuk keindahan interior Anda. Mempersembahkan sakelar terbaru tipe BS "Acrosea series" dari Panasonic dengan kualitas tinggi dengan semua fitur keamanan.

*A=American type, BS=British Standard type, C=Continental type. Kotaknya berbeda.



Melalui pengaplikasian teknologi tingkat tinggi guna mencapai kualitas hidup yang lebih baik, kami sungguh berkomitmen atas kualitas produk. Tolak ukur kami dalam mengembangkan produk berasal dari tradisi kerajinan Jepang. Berstandarkan tradisi kerajinan Jepang atas kualitas yang tanpa kompromi, Panasonic mengembangkan dan memproduksi produk berkualitas serta memasarkannya kepada konsumen di seluruh dunia.

Keamanan dan Keandalan yang Sebenarnya

KEAMANAN DAN KENYAMANAN

1 Materi Urea Resin Tahan Api

Selain memastikan perlindungan terhadap tegangan listrik, semua peralatan dirancang tahan lama dan aman

Konstruksi terisolasi total

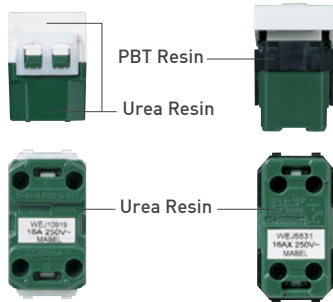

■ Perlindungan terhadap tegangan listrik ➔ Konstruksi terisolasi total

Karakter Material Terlampir (rujukan)

	Urea	PBT	Polycarbonate
Ketahanan terhadap panas	Baik	Baik	Sedang
Kemampuan lacak	Sangat baik	Baik	Buruk
Kemampuan berhenti secara otomatis	Baik	Baik	Baik

2 Instalasi Aman dan Cepat Terminal yang mudah disambungkan

Penggunaan terminal untuk keseluruhan perangkat menjamin keamanan tingkat tinggi dan kemudahan pemasangan.

Kabel & perangkat

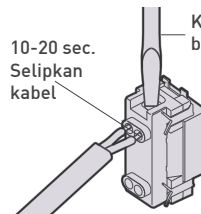

(Pillar Terminal)

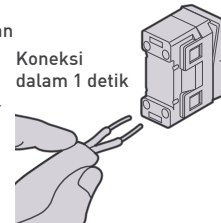

(Quick Connect/Global Terminal)



Quick Connect Terminal
Solid Wire : 1.5-2.5mm²



Quick Connect Terminal II
Solid Wire : 1.5-2.5mm²
Stranded Wire : 1.5-2.5mm²



Global Terminal
Solid Wire : 1.5-4mm²
Stranded Wire : 1.5-4mm²

3 Lebih aman

Suara pelanggan ①

Khawatir dengan colokan listrik yang terbuka dan berbahaya bagi anak kecil.

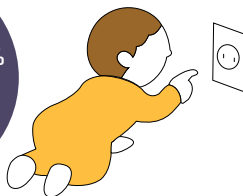
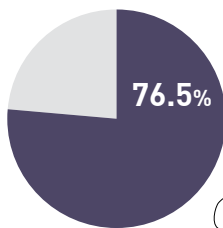

※ Menurut penelitian kami.

Gunakanlah colokan listrik dengan tutup pengaman "Stop kontak [CP]" untuk mencegah jari anak masuk ke dalam.



Contoh: Stop Kontak dengan [CP]

Suara pelanggan ②

Melihat percikan listrik dari colokan listrik.

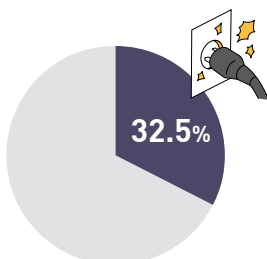

Menemukan colokan yang keras atau goyah.

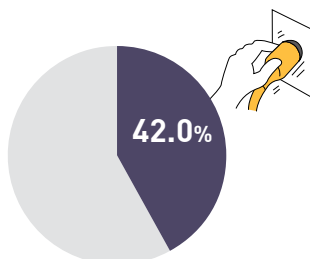

※ Menurut penelitian kami.

Pilihlah peralatan listrik yang berkualitas sesuai dengan standar IEC yang telah melewati uji keamanan yang ketat seperti ketahanan terhadap panas dan penggunaan berulang (10.000x pasang copot)



New Products

NEW 2-Port USB Type-A CHARGER

USB Type-A: Standar tipe USB



Quick Connect Terminal II
Solid Wire : 1.5-2.5mm²
Stranded Wire : 1.5-2.5mm²



WEF1172W [White]



WEF1172H [Gray]

Daya Tahan – Tahan Lama

Lulus uji coba colok 30.000X dengan standar kualitas Panasonic yang lebih tinggi dibandingkan uji coba pada umumnya.

Senyap – Lolos uji kualitas Panasonic (20dB)*

Cocok digunakan pada ruang tidur, hotel dan kantor.
(*30dB: suara bisikan; 20dB: suara napas ketika tidur)

Aman – Menggunakan materi urea resin

Tidak hanya aman untuk penggunaan di dalam rumah, tapi juga pada fasilitas publik dan transportasi.

Seri yang dapat digabungkan

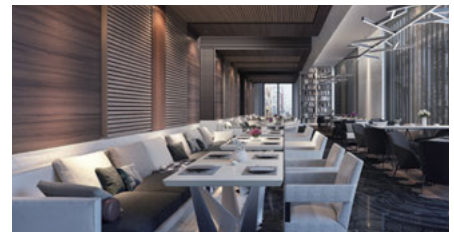
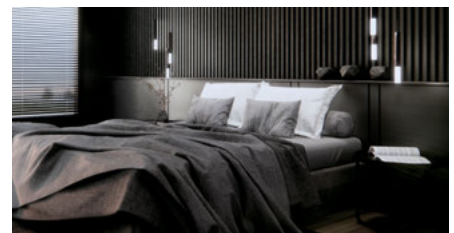
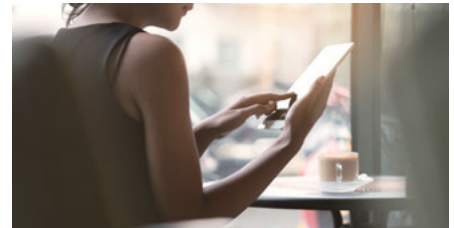

NEW HDMI CONNECTOR

Konektor HDMI mudah digunakan dan nyaman untuk terhubung HDMI kabel.

Produk ini dapat menghubungkan layar TV dengan komputer Anda melalui pengkabelan yang tertanam di dinding.



WEG2021 [White]



WEG2021H [Gray]



WEG2021B-F [Black]

Terhubung dengan mudah

Mudah terhubung HDMI di antara monitor (TV,dLL) dan devices (PC,dLL).

Tahan lama

Dukungan plug in-out hingga 10.000X sehingga tahan lama.

Seri yang dapat digabungkan



Gaya minimalis kontemporer dengan Teknologi masa kini.

Stylee hadir dengan konsep minimalis yang didesain untuk menyatu dengan desain interior yang simple dan modern.



FULL-COLOR WIDE SERIES

Stylee

[C-Type Wiring Device]



FULL-COLOR WIDE SERIES

Stylee 

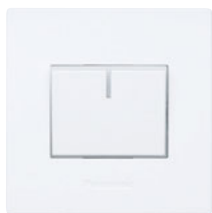

WHITE (Sakelar ECO"B")

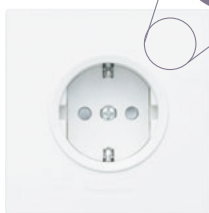

WHITE (Stop Kontak)

DESAIN MINIMALIS

Desain bergaya berdasarkan garis lurus. Desain ramping yang selaras dengan ruang interior. Dengan sentuhan akhir "Mat Finish", cahaya dipantulkan dengan sangat lembut sehingga dapat memberikan atmosfer ketenangan dan kenyamanan.



1 jam : 10 lm (setelah dimatikan) 3 jam : 4 lm (setelah dimatikan) 7 jam : 1.4 lm (setelah dimatikan)

Lumen (mcd/m ²)	Tingkat terang cahaya
5 atau lebih	Obyek sangat terang dan terlihat dengan jelas
3 atau kurang	Obyek terlihat
0.3 atau kurang	Obyek kabur dan sulit terlihat

Setara dengan standar regulasi Jerman DIN67510: Photoluminescent Pigment and Product test

SAKELAR "ECO"

- Dapat menyimpan cahaya dari sinar matahari atau sumber cahaya lainnya.
- Menggunakan material Luminescent terkini yang menghasilkan emisi cahaya lebih tahan lama.
- Tidak mengandung zat radioaktif, sehingga aman dan ramah lingkungan.

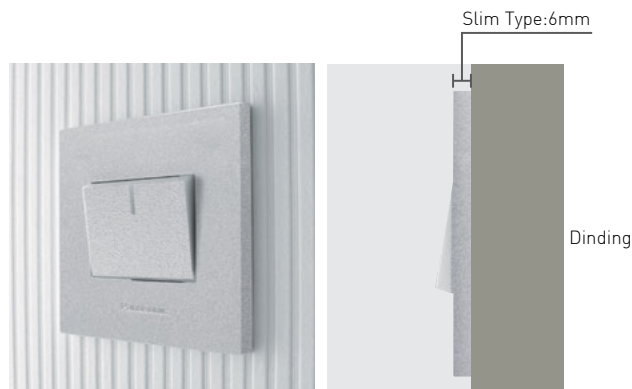

ULTRA SLIM

Desain yang ramping sangat cocok untuk gaya minimalis dengan ketebalan dari dinding ke permukaan plat hanya 6mm. (7.7mm untuk Clear White, Clear Green, Aluminum Silver)

WHITE



Desain :
Model Solid White yang simpel sangat cocok dipadupadankan dengan model ruangan apapun.

Dapat dikombinasikan dengan :
Painted Wall / Natural Wood Interior

SILVER

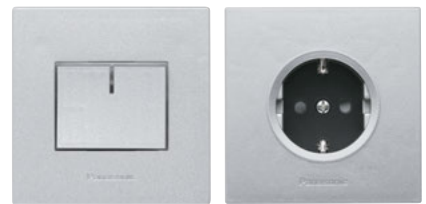

Desain :
Dengan lapisan matte Metallic Silver yang berkualitas tinggi, dapat membuat suasana lebih tenang dan santai.

Dapat dikombinasikan dengan :
Achromatic / Concrete / Dark Wood Interior

MATTE BLACK

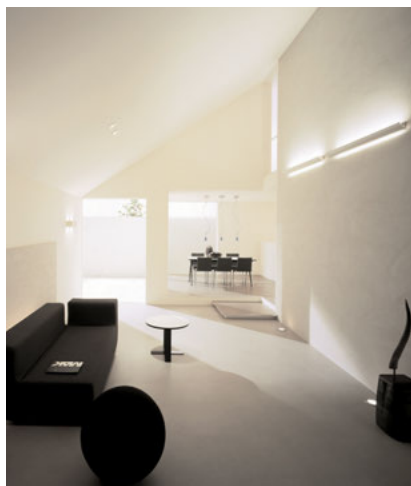

Desain :
Model Matte Black memberikan kesan yang tegas pada interior ruangan membuat terlihat lebih indah.

Dapat dikombinasikan dengan :
Stone / Dark-Colored Interior

CLEAR WHITE



Desain :
Tekstur lapisan kaca pada model Clear White membuat refleksi cahaya lebih terang pada ruangan dan sangat cocok untuk interior bernuansa cerah.

Dapat dikombinasikan dengan :
Painted Wall / Glass / Marble Interior

FULL-COLOR WIDE SERIES
Style

FULL-COLOR WIDE SERIES

CLEAR GREEN

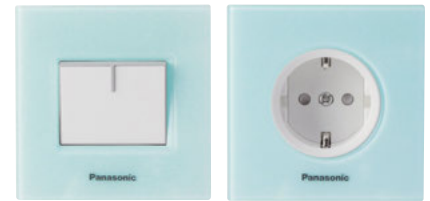

Desain :
Model Clear Green menghasilkan kombinasi warna yang unik dan tekstur yang jernih.

Dapat dikombinasikan dengan :
Glass / Marble Interior

FLASIMO

MINIMAL ART

A' mode

ALUMINUM SILVER

Material : Aluminum Plate



Desain :
Model yang paling elegan, model Aluminum Silver dengan menggunakan material aluminium asli dapat meningkatkan suasana yang penuh dengan kemewahan.

Dapat dikombinasikan dengan :
Concrete / Dark Wood Interior

FULL-COLOR SERIES

Acrosea

Konsep Warna



White
W



Silver
MWS



Matte Black
B



Clear White
CW



Clear Green
CGX



Aluminum Silver
AIS

Sakelar

WESJ5941

Sakelar ECO "B" (1 Arah) Wide
16AX 250V~



WESJ5941MWS WESJ5941B



WESJ5931

Sakelar ECO "B" (1 Arah)
16AX 250V~



WESJ5931MWS WESJ5931B



WESJ5942

Sakelar ECO "C" (2 Arah) Wide
16AX 250V~



WESJ5942MWS WESJ5942B



WESJ5932

Sakelar ECO "C" (2 Arah)
16AX 250V~



WESJ5932MWS WESJ5932B



WESJ5934 Coming soon

Sakelar ECO "E" [Intermediate]
16AX 250V~



WESJ5581

Sakelar Iluminasi "B" (1 Arah) Wide
16AX 250V~



WESJ5581MWS WESJ5581B



WESJ5571

Sakelar Iluminasi "B" (1 Arah)
16AX 250V~



WESJ5571MWS WESJ5571B



WESJ5582

Sakelar Iluminasi "C" (2 Arah) Wide
16AX 250V~



WESJ5582MWS WESJ5582B



WESJ5572

Sakelar Iluminasi "C" (2 Arah)
16AX 250V~



WESJ5572MWS WESJ5572B



WESJ5534 Coming soon

Sakelar "E" [Intermediate]
16AX 250V~



Stop Kontak

WEJ57515

Sakelar dimmer
[Incandescent light control]
500W 220V~

WEJ57515H



WEJ57518

Sakelar dimmer
[Incandescent light control]
800W 220V~

WEJ57518H



WEJ5401-7

Tombol tekan "B"
10A 250V~

WEJ5401H-7



WEJ10919

Stop kontak universal
16A 250V~

WEJ10919H



WEJ1041 Coming soon

Multiple Receptacle
dengan Safety Shutter
16A 250V~

WEJ1041H



FULL-COLOR WIDE SERIES
Stylee

FULL-COLOR WIDE SERIES

FLASIMO

MINIMAL ART

A'mode

FULL-COLOR SERIES

Acrosea



Quick Connect Terminal
Solid Wire : 1.5-2.5mm²



Quick Connect Terminal II
Solid Wire : 1.5-2.5mm²
Stranded Wire : 1.5-2.5mm²



Global Terminal
Solid Wire : 1.5-4mm²
Stranded Wire : 1.5-4mm²

Aksesoris

WEF1172W NEW

2-port USB Type-A Charger ZA

WEF1172H



WEJ2164/WEJ2166

Jack modul telepon (6P 4C)/(6P 6C)

WEJ2164H/WEJ2166H



WEJ2488

Jack modul transmisi data CAT5E (8P 8C)

WEJ2488H



WEJ24886

Jack modul transmisi data CAT6 (8P 8C)

WEJ24886H



WEJ2501

Terminal TV tipe DIN

WEJ2501H



WEG2021 NEW

Connector for HDMI Connection

WEG2021H



WEJ3020

Chip kosong

WEJ3020H



WNJ9986

Condensor untuk Sakelar Iluminasi 300V~ 0.1mF

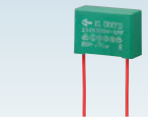

Sakelar Iluminasi

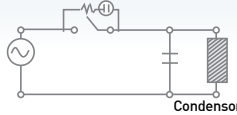

Stop Kontak & Plat

WESJP1121

Stop kontak dengan grounding (CP) 16A 250V~ Screw Terminal (Only Rigid Cu 1.5-4.0mm²)



WESJP11212

Stop kontak dengan grounding (CP) dan plate 2-gang 16A 250V~ Screw Terminal (Only Rigid Cu 1.5-4.0mm²)



WESJP11222

Stop kontak dengan grounding ganda (CP) 16A 250V~ Screw Terminal (Only Rigid Cu 1.5-4.0mm²)



WESJP11233

Stop kontak dengan grounding 3-gang (CP) 16A 250V~ Screw Terminal (Only Rigid Cu 1.5-4.0mm²)



WESJP11223

Stop kontak dengan grounding 3-gang (CP) kombinasi 16A 250V~ Screw Terminal (Only Rigid Cu 1.5-4.0mm²)



WBSJ1214

Stop kontak AC 13A 250V~ (Dapat dipakai box : BS type) Screw Terminal (Only Rigid Cu 2.5-6.0mm²)



*WBSJ1214 hanya tersedia dalam 3 warna (W/MWS/B).

WESJ78019

1-gang 1-device

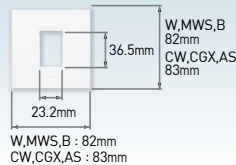

WESJ78029

1-gang 2-device

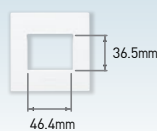

WESJ78049

2-gang 4-device

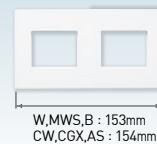

WESJ78069

3-gang 6-device



White

Silver

Matte Black

Clear White

Clear Green

Aluminum Silver

Chime

EGG331

Weatherproof Push Button for Door Chime 1A 220V~



EBG888

Door Chime 220W~ Two Tone 9.5W, 50Hz Easy-to-Hear 82 dB Chime



BOX

WEJ5911N

C-Type Box Inbow

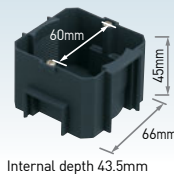

Desain tipis yang stylish. Fleksibel dengan gaya yang abadi.

Wide Series memiliki desain minimalis dan tipis dengan pilihan warna dan material yang sangat fleksibel untuk segala gaya interior Anda - mulai dari gaya konservatif, modern, sederhana, hingga elegan. Sebuah paduan sempurna desain dan teknologi dengan gaya yang abadi.



FULL-COLOR WIDE SERIES

(C-Type Wiring Device)



FULL COLOR
WIDE
SERIES



PALING BANYAK DIPILIH DI INDONESIA

Tipe Wiring Devices yang paling populer dengan berbagai pilihan warna yang dapat menyesuaikan dengan berbagai gaya interior.

White & Pastel



VARIAN WARNA YANG BERAGAM

Desain sakelar hadir dengan beragam varian warna sehingga cocok diaplikasikan dengan berbagai gaya interior Anda.

Metallic



FULL-COLOR WIDE SERIES

Konsep Warna

White & Pastel



White
W



Green
TIG



Blue
TL



Pink
TIN



Cream
F

Metallic



Champagne Silver
MYX



Metallic Blue
MDZ



Wine Red
MRE



Gold
MYZ



Dark Brown
MAE

STANDARD **W** White

PASTEL **TIG** Green **TL** Blue **TIN** Pink **F** Cream

METALLIC **MYX** Champagne Silver

MDZ Metallic Blue **MRE** Wine Red

MYZ Gold

MAE Dark Brown

Sakelar

WEJ5541

Sakelar "B" (1 Arah) Wide
16AX 250V~



WEJ5531

Sakelar "B" (1 Arah)
16AX 250V~



WEJ5542 □□□

Sakelar "C" (2 Arah) Wide
16AX 250V~



WEJ5532 □□□

Sakelar "C" (2 Arah)
16AX 250V~



WEJ5533-7

Coming soon

Sakelar "D" [Double Pole]
20A 250V~
Pillar Terminal
[Solid, Stranded and
Flexible Wire: 1.5-4mm²]



WEJ5534

Coming soon

Sakelar "E" [Intermediate]
16AX 250V~



WEJ5581

Sakelar Iluminasi "B" (1 Arah) Wide
16AX 250V~



WEJ5571

Sakelar Iluminasi "B" (1 Arah)
16AX 250V~



WEJ5582 □□□

Sakelar Iluminasi "C" (2 Arah) Wide
16AX 250V~



WEJ5572 □□□

Sakelar Iluminasi "C" (2 Arah)
16AX 250V~



WEJ57515

Sakelar dimmer
(Incandescent light control)
500W 220V~

WEJ57515H



WEJ57518

Sakelar dimmer
(Incandescent light control)
800W 220V~

WEJ57518H



※ Sakelar berwarna putih diatas ini merupakan pasangan kombinasi dari plat tipe Pastel.

STANDARD **W** White

METALLIC **MYX** Champagne Silver

MYZ Gold

MDZ Metallic Blue **MRE** Wine Red

MAE Dark Brown



Quick Connect Terminal
Solid Wire : 1.5-2.5mm²



Quick Connect Terminal II
Solid Wire : 1.5-2.5mm²
Stranded Wire : 1.5-2.5mm²



Global Terminal
Solid Wire : 1.5-4mm²
Stranded Wire : 1.5-4mm²

Stop Kontak

WEJ5401-7
Tombol tekan "B"
10A 250V-

WEJ5401H-7

WEJ10919
Stop Kontak Universal
16A 250V-

WEJ10919H

WEJ1041 Coming soon
Multiple Receptacle
dengan Safety Shutter
16A 250V-

WEJ1041H

WEF1172W NEW
2-port USB Type-A Charger
2A

WEF1172H

Aksesoris

WEJ2164
Jack modul telepon
(6P 4C)

WEJ2164H

WEJ2166
Jack modul telepon
(6P 6C)

WEJ2166H

WEJ2488
Jack modul transmisi data
CAT5E (8P 8C)

WEJ2488H

WEJ24886
Jack modul transmisi data
CAT6 (8P 8C)

WEJ24886H

WEJ2501
Terminal TV tipe DIN

WEJ2501H

WEG2021 NEW
Connector for HDMI Connection

WEG2021H

WEJ3020
Chip kosong

WEJ3020H

WNJ9986
Condensor untuk
Sakelar Iuminasi 300V- 0.1mF

Stop Kontak & Plat

WEJP1121-7 **WEJP1131-7**
Stop Kontak Schuko dengan Grounding (CP) (Non CP)
Screw Terminal (Only Rigid Cu 1.5-4.0mm²)

WEJP11212-7 **WEJP11312-7**
Stop Kontak Schuko dengan Grounding & Frame 2 Gang (CP) (Non CP)
Screw Terminal (Only Rigid Cu 1.5-4.0mm²)

WEJP11222-7 **WEJP11322-7**
Stop Kontak Schuko dengan Grounding Ganda (CP) (Non CP)
Screw Terminal (Only Rigid Cu 1.5-4.0mm²)

WBJ1214W
Stop Kontak AC dengan Sakelar "D"(Double Pole)
13A 250V-(Dapat dipakai box: BS type)
Screw Terminal (Only Rigid Cu 2.5-6.0mm²)

WEJ9111W
Steker untuk Stop kontak AC

WBJ1214W-3K
Stop Kontak AC dengan Sakelar "D"(Double Pole) dan kontak Outbow
13A 250V-(Dapat dipakai box:BS type)
Screw Terminal (Only Rigid Cu 2.5-6.0mm²)

STANDARD W White T G Green T L Blue T N Pink F Cream METALLIC M Y X Champagne Silver M D Z Metallic Blue M R E Wine Red M Y Z Gold M A E Dark Brown

FULL-COLOR WIDE SERIES

FULL-COLOR WIDE SERIES
Style

FULL-COLOR WIDE SERIES

FLASIMO

MINIMAL ART

A' mode

FULL-COLOR SERIES

Acrosea

WEJ78019 □□□
Frame 1 Gang
1 Device



WEJ78029 □□□
Frame 1 Gang
2 Device



WEJ78049 □□□
Frame 2 Gang
4 Device



WEJ7823 □□□
3 Gang 6 Device



WEJ30029 □□□
Inside Cover untuk WEJ7823



WEJ1121-7
Stop Kontak Schuko dengan Grounding (CP)
untuk WEJ7823
Screw Terminal
(Only Rigid Cu 1.5-4.0mm²)

WEJ1121H-7



STANDARD **W** White | PASTEL **T G** Green | **T L** Blue | **T N** Pink | **F** Cream | METALLIC **M Y X** Champagne Silver | **M D Z** Metallic Blue | **M R E** Wine Red
M Y Z Gold | **M A E** Dark Brown

Weatherproof Cover Plate

WEJ89911 IP54
Cover Frame
Weatherproof



Chime

EGG331
Weatherproof Push Button
for Door Chime
1A 220V~



EBG888
Door Chime
220W~ Two Tone 9.5W, 50Hz
Easy-to-Hear 82 dB Chime



BOX

WEJ5911N
C-Type Box Inbow



Internal depth 43.5mm

WBJ6010W
Outbow Doost untuk Stop Kontak AC
(untuk WBJ1214W)



Fitur Weatherproof Cover Plate (WEJ89911) IP54

Produk ini, bila dipasang dengan Stop Kontak Panasonic atau dengan Steker biasa (hanya tipe kabel samping) di tempat terbuka, memenuhi standar keamanan tingkat tinggi IP54 (IEC60884-1)



Contoh kombinasi

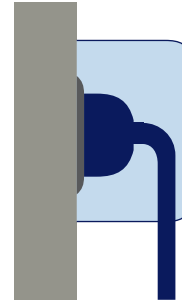

Produk ini dapat ditutup dengan kabel dimasukkan

Fitur Sakelar B,C,D,E

Sakelar "B" (1 Arah, Single Pole)

Paling banyak digunakan untuk menghidupkan dan mematikan beban seperti penerangan.

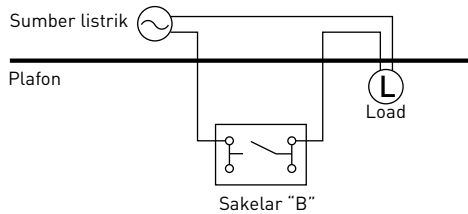

Sakelar "C" (2 Arah, Hotel)

Sakelar "C" adalah sakelar yang dapat dioperasikan dari dua titik lokasi yang berbeda. Dapat digunakan di tangga, koridor, dll.

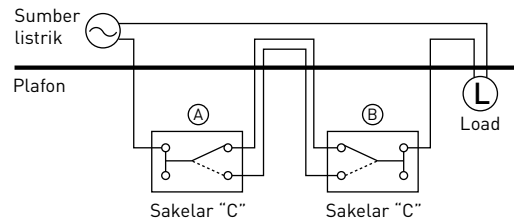

Sakelar "D" (Double Pole)

Dengan menyalakan dan mematikan "Double Pole" secara bersamaan, Anda dapat melindungi beban koneksi dengan lebih aman. (Direkomendasikan untuk AC, dll.)

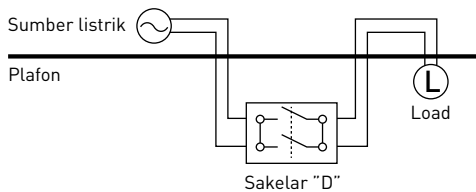

Sakelar "E" (Intermediate)

Sakelar "E" adalah sakelar yang dapat dioperasikan dari tiga atau lebih titik lokasi yang berbeda. Harus digunakan dengan kombinasi sakelar "C".

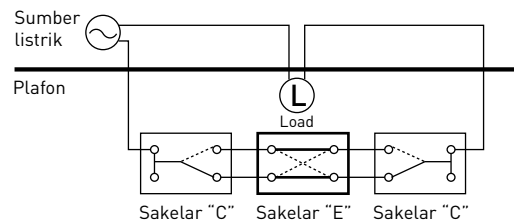

Desain Flat & Simple untuk gaya modern dan ekonomis.

FLASIMO

(C-Type Wiring Device)



FLASIMO

DESAIN

- Tampilan tipis persegi yang menarik.
- Warna putih yang Elegan sesuai dengan interior modern.
- Desain simpel modern dan minimalis.



KEAMANAN

- Di desain untuk penggunaan dalam waktu yang panjang dengan bahan yang tahan panas.
- Sesuai dengan Eropa ROHS compliant direktif, bebas dari CD, Hg, Cr6+, Pb, PBB, PBDEs.
- 100% diproduksi di Indonesia.



Sakelar

WCJP51181

Sakelar "B"(1 Arah)
1 Device
10AX 250V~
Screw Terminal
(Only Rigid Cu
1.5-2.5mm²)



WCJP52181

Sakelar "B"(1 Arah)
2 Devices
10AX 250V~
Screw Terminal
(Only Rigid Cu
1.5-2.5mm²)



Stop Kontak

WCJP1131

Stop Kontak dengan
grounding 16AX 250V~
Screw Terminal
(Only Rigid Cu
1.5-2.5mm²)



Aksesoris

WCJP2164

Jack Modul Telepon
(6P4C)



WCJP2488

Jack Modul transmisi
data CAT5E (8P8C)



WCJP2501

Terminal TV
tipe DIN



Chime

EGG331

Weatherproof Push Button
for Door Chime
1A 220V~



EBG888

Door Chime
220W~ Two Tone 9.5W, 50Hz
Easy-to-Hear 82 dB Chime



BOX

WEJ5911N

C-Type Box Inbow

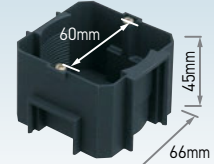

Internal depth 43.5mm

D I M E N S I

Unit : mm

WCJP51181

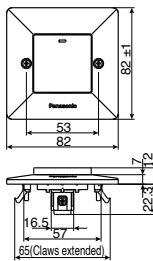

WCJP52181

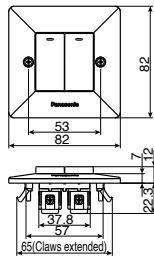

WCJP1131

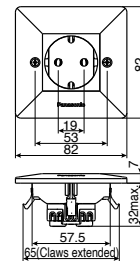

WCJP2164

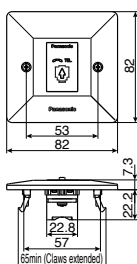

WCJP2488

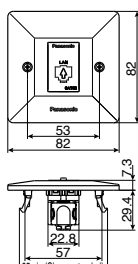

WCJP2501

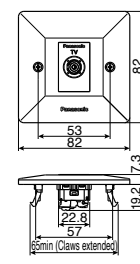

Balutan aluminium yang premium, karya seni dengan teknologi terkini.

MINIMAL ART series adalah sebuah teknologi yang dibalut dengan seni. Temukan keindahan dari desain asimetris sempurna yang sangat tipis menyatu dengan plat aluminium berkualitas tinggi. Tampilan dan teknologinya yang memukau akan menghadirkan kesan elegan yang Anda inginkan untuk segala gaya desain interior modern dan minimalis Anda.



MINIMAL ART

(A-Type Wiring Device)



MINIMAL ART

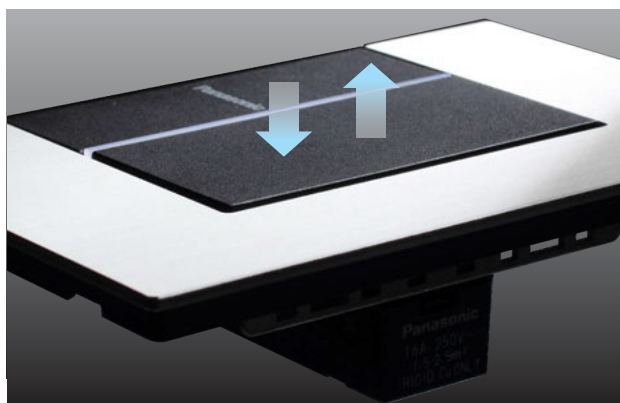

MEKANISME SAKELAR TERBARU YANG TAHAN PANAS DAN MUDAH DIGUNAKAN

Sistem push on - push off sakelar yang mudah untuk dioperasikan dengan hanya sedikit sentuhan.



DESAIN SUPER RAMPING YANG CANGGIH

Desain asimetris dari bahan aluminium setebal 2mm yang berkualitas.

Ketebalan dari dinding ke permukaan plat: 6.85mm



Quick Connect Terminal II
 Solid Wire : 1.5-2.5mm²
 Stranded Wire : 1.5-2.5mm²



Global Terminal
 Solid Wire : 1.5-4mm²
 Stranded Wire : 1.5-4mm²

Sakelar

WTEJP51552S

Sakelar Iuminasi "C"
 (2 Arah) 1 Device
 16AX 250V~



WTEJP52562S

Sakelar Iuminasi "C"
 (2 Arah) 2 Devices
 16AX 250V~



WTEJP53572S

Sakelar Iuminasi "C"
 (2 Arah) 3 Devices
 16AX 250V~



WTEJP54562S

Sakelar Iuminasi "C"
 (2 Arah) 4 Devices
 16AX 250V~



WTEJP55582S

Sakelar Iuminasi "C"
 (2 Arah) 5 Devices
 16AX 250V~



WTEJP56572S

Sakelar Iuminasi "C"
 (2 Arah) 6 Devices
 16AX 250V~



WEJ57813B-1

Sakelar Dimmer
 (Incandescent and Low
 Voltage Halogen with
 Transformer 12V Light Control)
 220VAC 300W



WEJ57816B-1

Sakelar Dimmer
 (Incandescent and Low
 Voltage Halogen with
 Transformer 12V Light Control)
 220VAC 500W



Stop Kontak

WZJ1121H

Stop Kontak Schuko (CPI), Gray
 16A 250V~
 Screw Terminal
 (Only Rigid Cu 1.5-4.0mm²)



Aksesoris

WEJ2164B1

Jack Modul Telepon
 (6P4C)



WEJ2488B1

Jack Modul transmisi data
 CAT5E(8P8C)



WEJ2488B1

Jack Modul transmisi data
 CAT6(8P8C)



WEJ2501B1

Terminal TV
 tipe DIN



WEG2021B-F NEW

Connector for HDMI
 Connection



WEJ3020B

Chip Kosong



WNJ9986

Condensator untuk
 Sakelar Iuminasi 300V- 0.1mF

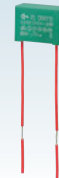

Plat

WTEJ6503S-1

1-Gang 3-Device



WTEJ6506S-1

2-Gang 6-Device



WTEJ1781S

1-Gang Plat Stop Kontak untuk
 WZJ1121H

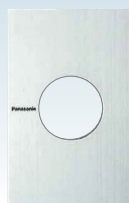

BOX

WVJ5911KN

A-type Box Inbow

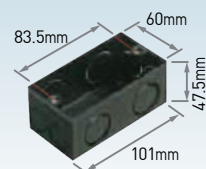

WVJ4811

A-type Box Inbow, Metal

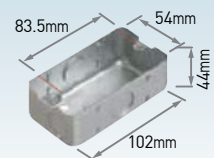

FULL-COLOR WIDE SERIES
Stylee

FULL-COLOR WIDE SERIES

FLASIMO

MINIMAL ART

A mode

FULL-COLOR SERIES

Acrosea

D I M E N S I

Unit : mm

WTEJP51552S

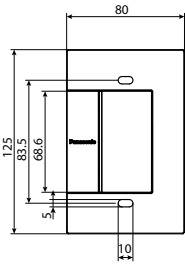

WTEJP52562S

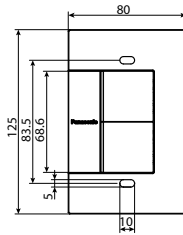

WTEJP53572S

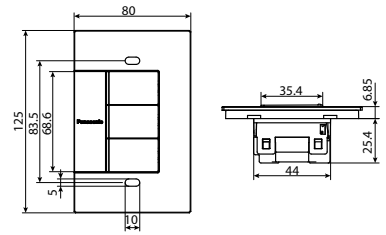

WTEJP54562S

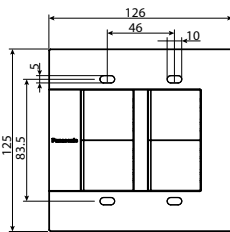

WTEJP55582S

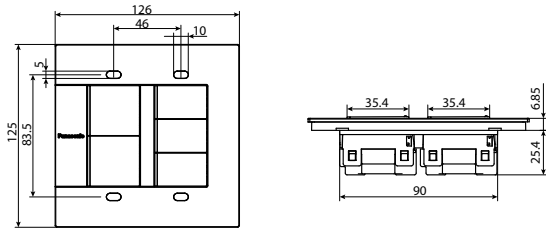

WTEJP56572S

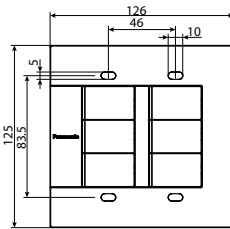

WEJ57813B-1

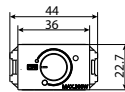

WEJ57816B-1

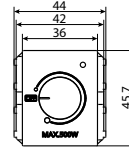

WZJ1121H

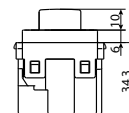
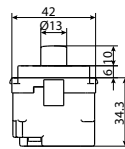
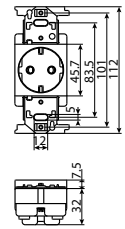

WEJ1081B-1

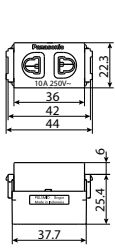

WEJ2164B-1

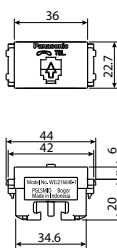

WEJ2488B-1

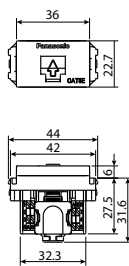

WEJ2488B-1

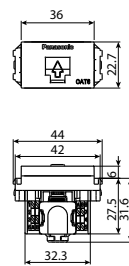

WEJ2501B-1

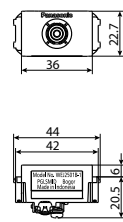

WEG2021B-F

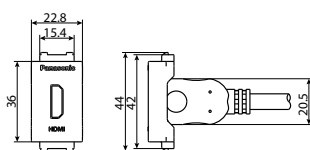

WEJ3020B

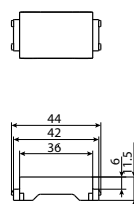

WTEJ6503S-1

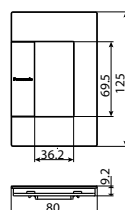

WTEJ6506S-1

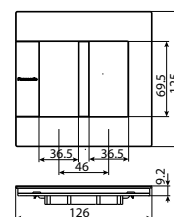

WTEJ1781S

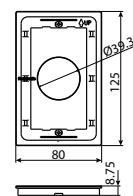

FULL-COLOR WIDE SERIES
Stylee

FULL-COLOR WIDE SERIES

FLASIMO

MINIMAL ART

A' mode

FULL-COLOR SERIES

Acrossea

Inspirasi seni Jepang. Aura kemewahan dalam kesederhanaan.

A'mode series terinspirasi dari seni Jepang yang sederhana namun memancarkan aura kemewahan. Sebuah desain elegan dengan filosofi zen yang cocok untuk interior minimalis Anda. Penggunaan nano technology yang pertama di dunia menghasilkan cahaya neon menjadi nuansa cahaya baru (new fluoroscopy) yang berpendar sangat lembut melintasi aksesoris garis metalik yang memukau.



A'mode SERIES

(A-Type Wiring Device)



A'mode
SERIES



NIKMATI GAYA TERBARU DAN DESAIN YANG MEWAH

Bentuk dan desain plat baru dengan kemewahan desain tombol yang modern. Menghadirkan aksent garis metalik yang memukau dan dapat diaplikasikan pada desain interior apapun.



DAPAT DIPASANG SECARA VERTIKAL DAN HORIZONTAL

A'mode sangat fleksibel karena dapat dipasang secara vertikal dan horisontal. Nikmati kebebasan berkreasi Anda dan memadukannya dengan desain interior rumah Anda.

Sakelar

WEHJ5511

Sakelar "B" (1 Arah)
3-Device Modul
16AX 250V~



WEHJ5521

Sakelar "B" (1 Arah)
1.5-Device Modul
16AX 250V~



WEHJ5531

Sakelar "B" (1 Arah)
1-Device Modul
16AX 250V~



WEHJ5512

Sakelar "C" (2 Arah)
3-Device Modul
16AX 250V~



WEHJ5522

Sakelar "C" (2 Arah)
1.5-Device Modul
16AX 250V~



WEHJ5532

Sakelar "C" (2 Arah)
1-Device Modul
16AX 250V~

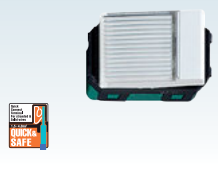

WEHJ5551

Sakelar Iuminasi "B" (1 Arah)
3-Device Modul
16AX 250V~
(Neon lamp : 220V~)



WEHJ5561

Sakelar Iuminasi "C" (1 Arah)
1.5-Device Modul
16AX 250V~
(Neon lamp : 220V~)



WEHJ5571

Sakelar Iuminasi "B" (1 Arah)
1-Device Modul
16AX 250V~
(Neon lamp : 220V~)



WEHJ5552

Sakelar Iuminasi "C" (2 Arah)
3-Device Modul
16AX 250V~
(Neon lamp : 220V~)



WEHJ5562

Sakelar Iuminasi "C" (2 Arah)
1.5-Device Modul
16AX 250V~
(Neon lamp : 220V~)



WEHJ5572

Sakelar Iuminasi "C" (2 Arah)
1-Device Modul
16AX 250V~
(Neon lamp : 220V~)



WEJ575181

Sakelar dimmer
(Incandescent light control)
800W 220V~



WEJ57515

Sakelar dimmer
(Incandescent light control)
500W 220V~



WEJ57518

Sakelar dimmer
(Incandescent light control)
800W 220V~



WEJ5401-7

Tombol tekan "B" 10AX 250V~



Stop Kontak

WZJ1121W

Stop kontak dengan grounding (CP)
16A 250V~
Screw Terminal
(Only Rigid Cu 1.5-4.0mm²)

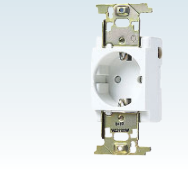

WEJ10919

Stop kontak universal 16A 250V~



WEF1172W

NEW

2-port USB Type-A Charger
2A



FULL-COLOR WIDE SERIES
Styleo

FULL-COLOR WIDE SERIES

FLASIMO

MINIMAL ART

A ' m o d e

FULL-COLOR SERIES

Acrosea



Quick Connect Terminal
Solid Wire : 1.5-2.5mm²



Quick Connect Terminal II
Solid Wire : 1.5-2.5mm²
Stranded Wire : 1.5-2.5mm²



Global Terminal
Solid Wire : 1.5-4mm²
Stranded Wire : 1.5-4mm²

Aksesoris

WEJ2164

Jack modul telepon (6P4C)



WEJ2166

Jack modul telepon (6P 6C)



WEJ2488

Jack modul transmisi data CAT5E (8P 8C)



WEJ24886

Jack modul transmisi data CAT6 (8P 8C)



WEJ2501

Terminal TV tipe DIN (8P 8C)



WEG2021

NEW

Connector for HDMI Connection



WEJ3032W

Lamp indicator (Putih) 220V~



WEJ3032R

WEJ3032G



WEJ3020

Chip kosong



WNJ9986

Condensor untuk Sakelar iluminasi 300V~ 0.1µF



Plat

WEHJ6801W

1-gang 1-device



WEHJ6802W

1-gang 2-device



WEHJ6803W

1-gang 3-device



WZHJ1781W

1-gang untuk Stop Kontak (WZJ1121W)



WEHJ6806W

2-gang 6-device



Chime

EGG331

Weatherproof Push Button for Door Chime 1A 220V~



EBG888

Door Chime 220W~ Two Tone 9.5W, 50Hz Easy-to-Hear 82 dB Chime



BOX

WVJ5911KN

A-type Box Inbow

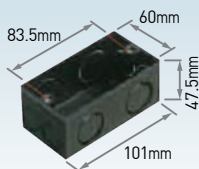

WVJ4811

A-type Box Inbow, Metal

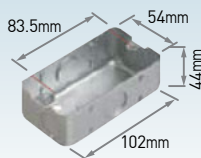

FULL-COLOR WIDE SERIES
Styleo

FULL-COLOR WIDE SERIES

FLASIMO

MINIMAL ART

A' mode

FULL-COLOR SERIES

Acrosea

Desain sederhana dan dirancang untuk kepraktisan.

Desainnya yang sederhana dengan teknologi terkini untuk kepraktisan penggunaan ruangan Anda.



FULL-COLOR SERIES

(A-Type Wiring Device)

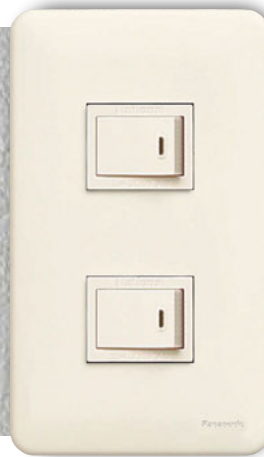

KEINDAHAN SEDERHANA TRADISIONAL

Seri pertama yang dirilis oleh Panasonic di Indonesia. Telah dicintai selama bertahun-tahun karena desainnya yang sederhana.



TAHAN PANAS, MEKANISME SAKELAR TERBARU YANG MUDAH DIGUNAKAN

Sakelar praktis dengan mekanisme sakelar sederhana dan bebas masalah.

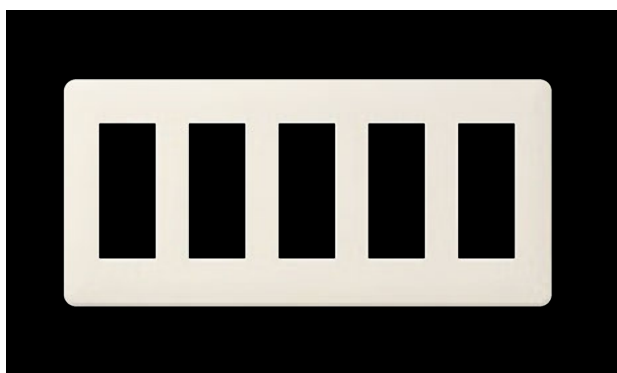

DAPAT DIINSTALL HINGGA 15 DEVICE

Temukan kebebasan menggabungkan sakelar, stop kontak dan aksesoris sesuai tujuan Anda hingga 15 device.

FULL-COLOR SERIES A-TYPE

Sakelar

WNJ5001

Sakelar "B" (1 Arah)
16AX 250V~
Screw Terminal
[Solid 1.5-2.5mm², Stranded 1.5-3.5mm²]



WNJ5002

Sakelar "C" (2 Arah)
16AX 250V~
Screw Terminal
[Solid 1.5-2.5mm², Stranded 1.5-3.5mm²]



WNJP575152

Sakelar Dimmer
(Incandescent Light Control)
500W 220-240V~
Applicable Wire
2-3.5mm²
Solid Wire Only



WNJP575253

Sakelar Dimmer dengan Sakelar "B"
(Incandescent Light Control)
500W 220-240V~
Applicable Wire
2-3.5mm²
Solid Wire Only



WNJP575283

Sakelar Dimmer dengan Sakelar "B"
(Incandescent Light Control)
800W 220-240V~
Applicable Wire
2-3.5mm²
Solid Wire Only



WNJP575213

Sakelar Dimmer dengan Sakelar "B"
(Incandescent Light Control)
1,500W 220-240V~
Applicable Wire
2-3.5mm²
Solid Wire Only



Stop Kontak

WZJ1121

Stop kontak dengan grounding (CP)
16A 250A~
Screw Terminal
(Only Rigid Cu 1.5-4.0mm²)



WZJ1122

Stop kontak dengan grounding (Non-CP)
16A 250A~
Screw Terminal
(Only Rigid Cu 1.5-4.0mm²)



Aksesoris

WNJ1091

Stop Kontak Universal
10A 250V~



WNTJ15649 Coming soon

Jack modul telepon(6P4C)



NRJ3160 Coming soon

Jack modul transmisi data CAT5E
(8P 8C)



NRJ3170 Coming soon

Jack modul transmisi data CAT6
(8P 8C)



Plat

WZJ1201

Terminal TV
Tipe DIN



WNJ3020

Chip Kosong



WNJ6801

1 Gang 1 Device



WNJ6802

1 Gang 2 Device



WNJ6803

1 Gang 3 Device



WZJ1781

1 Gang,
Untuk Stop Kontak Schuko
(WZJ1121/WZJ1122)



WNJ6891

Plat Penutup



WNJ6804

2 Gang 4 Device



FULL-COLOR WIDE SERIES
Style

FULL-COLOR WIDE SERIES

FLASIMO

MINIMAL ART

A' mode

FULL-COLOR SERIES

Acrosea



Quick Connect Terminal
Solid Wire : 1.5-2.5mm²

WNJ6806

2 Gang 6 Device



WNJ6009

3 Gang 9 Device

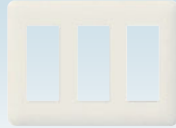

WNJ6012

4 Gang 12 Device



WNJ6015

5 Gang 15 Device



Chime

EGG331

Weatherproof Push Button for Door Chime
1A 220V-



EBG888

Door Chime
220W- Two Tone 9.5W, 50Hz
Easy-to-Hear 82 dB Chime



BOX

WVJ5911KN

A-type Box Inbow

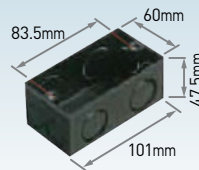

WVJ4811

A-type Box Inbow, Metal

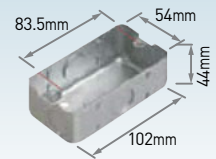

FULL-COLOR WIDE SERIES
Style0

FULL-COLOR WIDE SERIES

FLASIMO

MINIMAL ART

A'mode

FULL-COLOR SERIES

Acrosea

Paduan serasi untuk keindahan interior Anda.

Mempersembahkan Sakelar terbaru tipe BS "Acrosea series" dari Panasonic dengan kualitas tinggi dengan semua fitur keamanan.



Acrosea

(BS-Type Wiring Device)



Acrosea
BS TYPE WIRING DEVICES



KESEMPURNAAN DESAIN DENGAN PERMUKAAN YANG HALUS, SANGAT SERASI UNTUK BERBAGAI JENIS PERMUKAAN DINDING

Desain yang dibuat dengan hati-hati dengan hasil akhir putih yang halus, sehingga akan menyatu dengan permukaan apa pun.



BAHAN TAHAN API

Dibuat dari urea resin dengan kelas V-0 memiliki ketahanan yang tinggi terhadap panas api.

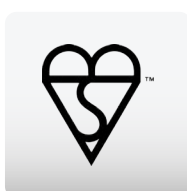

SESUAI STANDAR IEC, BS DAN SNI

Desain mengacu kepada
SNI IEC-60669-1, BS-1363-2

Sakelar

WABJ5011-N

Sakelar "B"
[1 Arah] 1 Device
Pillar Terminal
(Applicable Wire 1.0-4.0mm²)



WABJ5021-N

Sakelar "B"
[1 Arah] 2 Devices
Pillar Terminal
(Applicable Wire 1.0-4.0mm²)



WABJ5031-N

Sakelar "B"
[1 Arah] 3 Devices
Pillar Terminal
(Applicable Wire 1.0-4.0mm²)



WABJ5012-N

Sakelar "C"
[2 Arah] 1 Device
Pillar Terminal
(Applicable Wire 1.0-4.0mm²)



WABJ5022-N

Sakelar "C"
[2 Arah] 2 Devices
Pillar Terminal
(Applicable Wire 1.0-4.0mm²)



WABJ5032-N

Sakelar "C"
[2 Arah] 3 Devices
Pillar Terminal
(Applicable Wire 1.0-4.0mm²)



WABJ5303-N

Sakelar "D" (Double Pole) 20A
dengan Indikator
Pillar Terminal
(Applicable Wire 2.5-6.0mm²)



WABJ5511-N

Push Button "Bell" symbol
1 Gang 10A
Pillar Terminal
(Applicable Wire 1.0-4.0mm²)



Stop Kontak

WABJ1610-N

Stop Kontak Schuko [CP]
Screw Terminal
(Only Rigid Cu 1.5-4.0mm²)



WABJ1211-N

Stop Kontak AC 13A
dengan Sakelar
Pillar Terminal
(Applicable Wire 2.5-6.0mm²)



Aksesoris

WABJ3118-N

Modul Telepon (6P 4C)



WABJ3217-N

Modul Data (CAT6)



BOX

WABJ3010-N

Modul TV tipe DIN



WABJ8010-N

Plat Penutup



WABJ5911-N

BS-Type Box Inbow



FULL-COLOR WIDE SERIES
Stylee

FULL-COLOR WIDE SERIES

FLASIMO

MINIMAL ART

A' mode

FULL-COLOR SERIES

Acrosea

D I M E N S I

Unit : mm

WABJ5011-N
WABJ5012-N

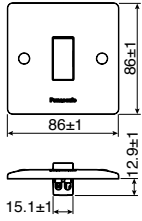

WABJ5021-N
WABJ5022-N

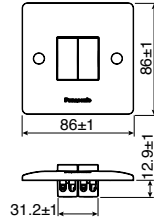

WABJ5031-N
WABJ5032-N

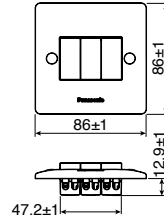

WABJ5303-N

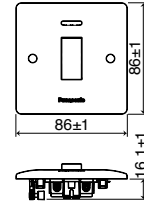

WABJ5511-N

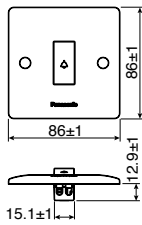

WABJ1610-N

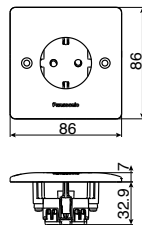

WABJ1211-N

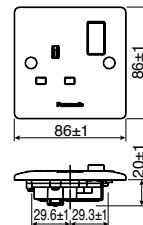

WABJ3118-N

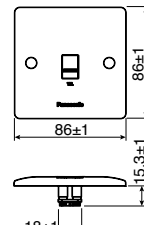

WABJ3217-N

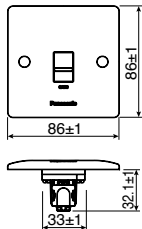

WABJ3010-N

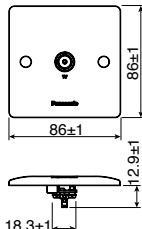

WABJ8010-N

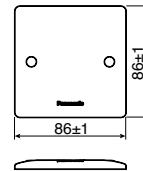

WABJ5911-N

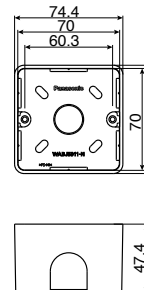

FULL-COLOR WIDE SERIES
Styleo

FULL-COLOR WIDE SERIES

FLASIMO

MINIMAL ART

A' mode

FULL-COLOR SERIES

Acrosea

HOTEL ACCESSORIES



Contoh Kombinasi

Sebelah Pintu



Komposisi

- Plate: WEHJ6803W
- DND Indicator: WEG3032R-021P
- MUR Indicator: WEG3032G-021P
- Tombol tekan : WEJ5401-7
- BOX: WVJ5911KN

※Contoh metode pengkabelan: Silakan lihat halaman 47.

Dalam Kamar



Komposisi

- Plate: WESJ78029
- DND SW: WEJ5002K-02
- MUR SW: WEJ5001K-03
- Chime: EBG888
- BOX: WEJ5911KN

Aksesoris untuk Hotel

WEJ5781WK Coming soon

Key Card Switch



WEJ5002K-02 Coming soon

Sakelar "C" untuk indikasi "Don't Disturb"



WEJ5001K-03 Coming soon

Sakelar "B" untuk indikasi "Make Up Room"



WEG3032R-021P

Pilot Lamp for Indication "Don't Disturb"(Red) 220V~



WEG3032G-031P

Pilot Lamp for Indication "Make Up Room"(Green) 220V~



WEJ5401-7

Tombol tekan "B" 10AX 250V~



WEB1051W

Shaver Receptacle (White) Input :220V~ Output :240V/110V~20VA



WEJ1041 Coming soon

Multiple Receptacle dengan Safety Shutter 16A 250V~



WEF1172W NEW

2-port USB Type-A Charger 2A



WEJ2164/WEJ2166

Jack modul telepon (6P 4C)/ (6P 6C)



WEJ2488

Jack modul transmisi data CAT5E (8P 8C)



WEJ24886

Jack modul transmisi data CAT6 (8P 8C)



WEJ2501

Terminal TV tipe DIN



WEG2021 NEW

Connector for HDMI Connection, White



EBG888

Door Chime 220W~ Two Tone 9.5W, 50Hz Easy-to-Hear 82 dB Chime



ALPHACUBE SERIES

Desain sederhana dan kompak.



HOTEL ACCESSORIES

Alphacube

S E R I E S

ALPHACUBE

Sakelar & Stop Kontak

WSJ3001

Sakelar "B" (1 Arah)
1 Device Outbow



WSJ3900

Sakelar "B" (1 Arah)
2 Devices Outbow



WKJ1131

Stop Kontak Outbow



FLOOR OUTLET SERIES

D I M E N S I

Unit: mm

WSJ3001

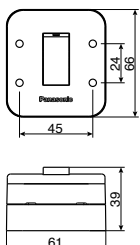

WSJ3900

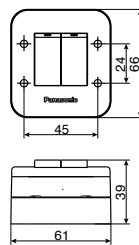

WKJ1131

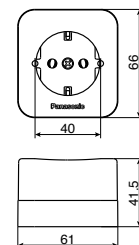

PASSIVE INFRARED SENSOR

AUTOMATIC TIME SWITCH

METODE PENGKABELAN

Sakelar

Contact Structure

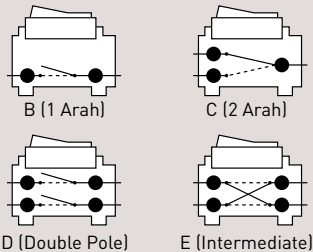

Sakelar "B", 1 Arah

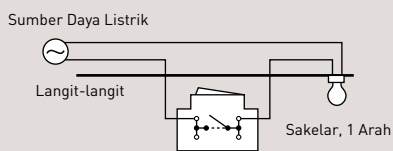

Contoh Sakelar
WESJ5941 **WEJ5541** **WCJP51181**
WEHJ5511 **WNJ5001** **WABJ5011-N**

Sakelar "C", 2 Arah

Operasi satu perlengkapan dari dua lokasi.

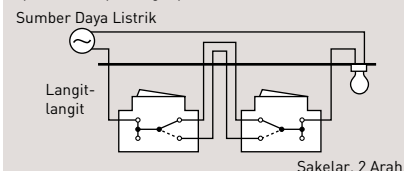

Contoh Sakelar
WESJ5942 **WEJ5542** **WTEJP51552S**
WEHJ5512 **WNJ5002** **WABJ5012-N**

Sakelar "D", Double Pole

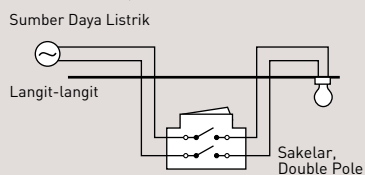

Contoh Sakelar
WEJ5533-7

Sakelar "E", Intermediate

Operasi satu perlengkapan dari 3 lokasi dalam kombinasi dengan sakelar C.

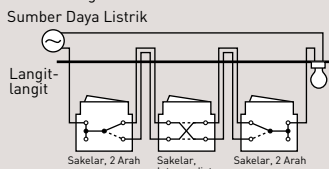

Contoh Sakelar
WESJ5534 **WESJ5934** **WEJ5534**

Instruksi pengkabelan (Kombinasi dengan lampu pilot)

Indikasi Lokasi Lampu Pilot

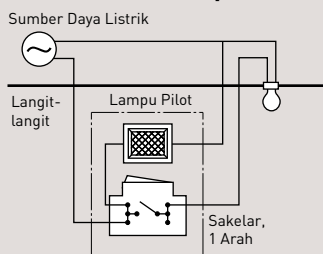

Sakelar Hidup/Lampu Hidup

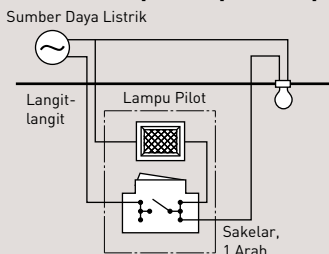

Sakelar Mati/Lampu Hidup

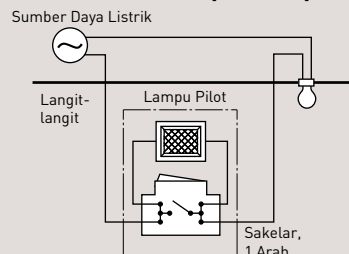

Door Chime

EGG331/EBG888

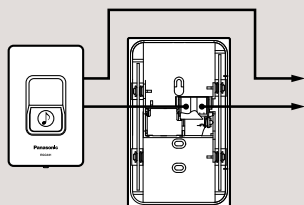

Unit Dimmer

WEJ575181 **WEJ57816B-1** **WEHJ57518**
WEJ57515 **WEJ57515** **WEJ57813B-1**
WEJ57518 **WNJP575152**

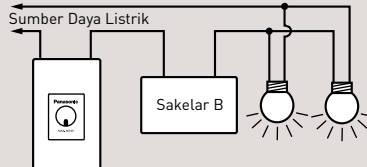

D I M E N S I

STYLEE

Unit : mm

WESJ5941
WESJ5942
WESJ5581
WESJ5582

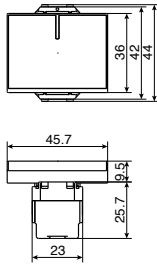

WESJ5931
WESJ5932
WESJ5571
WESJ5572

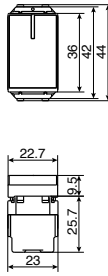

WESJ5934

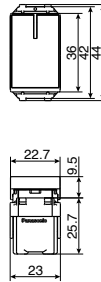

WESJ5534

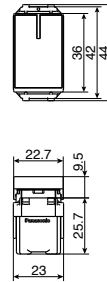

WESJP1121

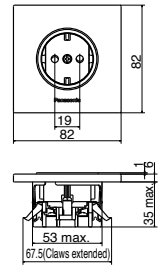

WESJP11212

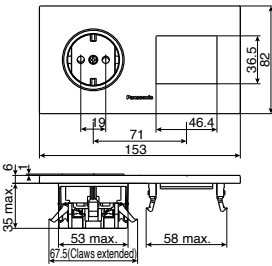

WESJP11222

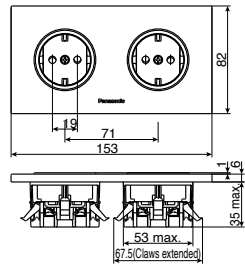

WESJP11233

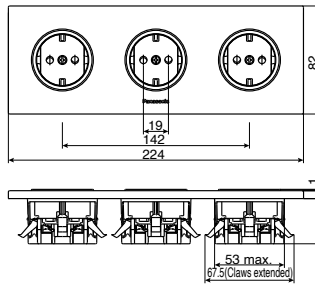

WESJP11223

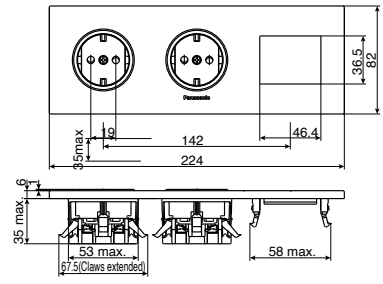

WBSJ1214

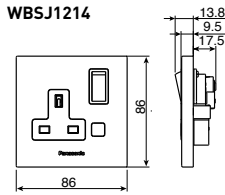

WESJ78019

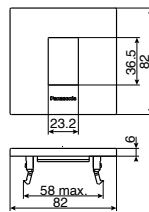

WESJ78029

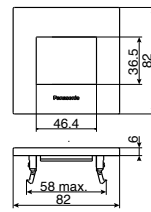

WESJ78049

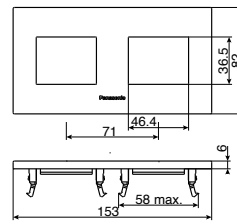

WESJ78069

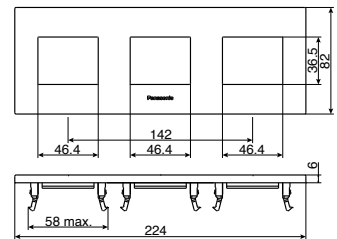

WIDE

Unit : mm

WEJ5541
WEJ5542
WEJ5581
WEJ5582

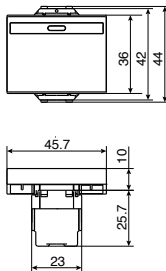

WEJ5531
WEJ5532
WEJ5571
WEJ5572

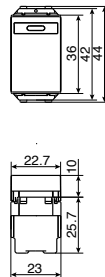

WEJ5533-7

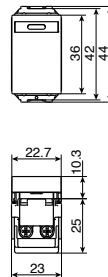

WEJ5534

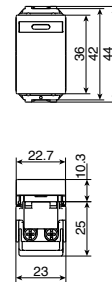

WEJP1121-7
WEJP1131-7

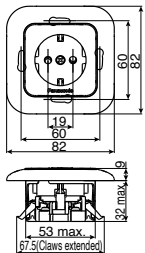

WEJP11212-7
WEJP11312-7
WEJP11222-7
WEJP11322-7

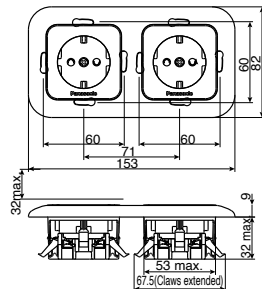

WEJ78019

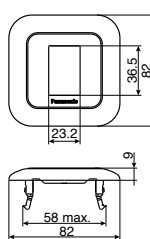

WEJ78029

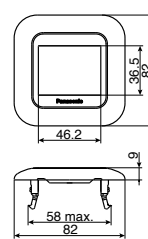

WEJ78049

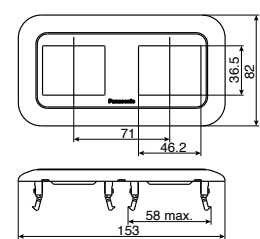

D I M E N S I

Unit : mm

WEJ7823

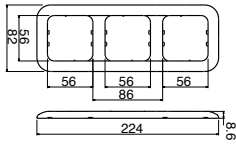

WEJ30029

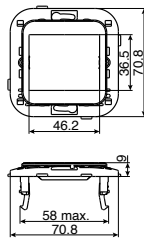

WEJ1121-7

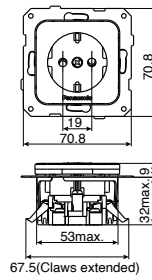

WEJ89911

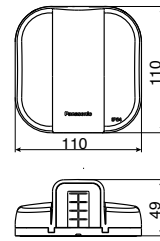

FLASIMO

※ Please see page 23

MINIMAL ART

※ Please see page 27

A'MODE

Unit : mm

WEHJ5511
WEHJ5512
WEHJ5551
WEHJ5552

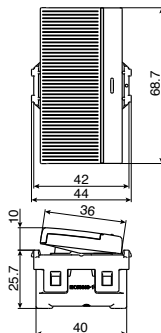

WEHJ5521
WEHJ5522
WEHJ5561
WEHJ5562

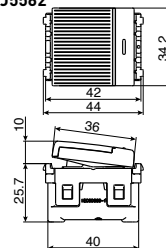

WEHJ5531
WEHJ5532
WEHJ5571
WEHJ5572

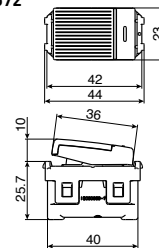

WEJ575181

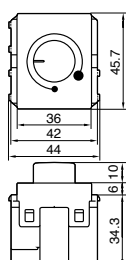

WEJ57515

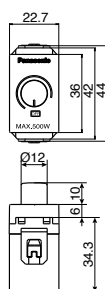

WEJ57518

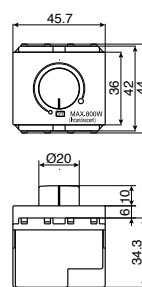

WZJ1121W

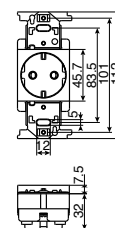

Unit : mm

WEJ10919

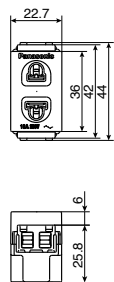

WEJ3032W

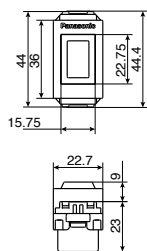

WEHJ6801W

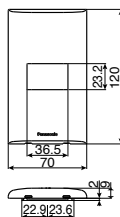

WEHJ6802W

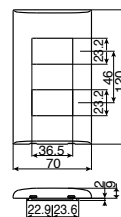

WEHJ6803W

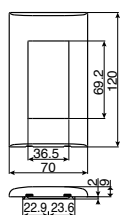

WZHJ1781W

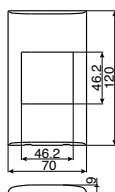

WEHJ6806W

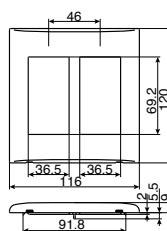

FULL-COLOR

Unit : mm

WNJ5001

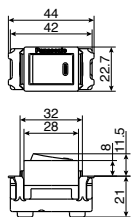

WNJ5002

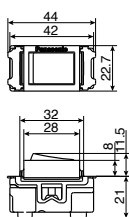

WNJP575152

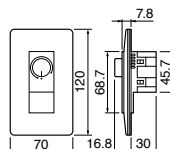

WNJP575253
WNJP575283

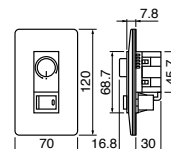

WNJP575213

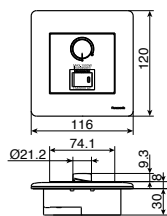

WZJ1121
WZJ1122

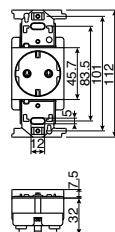

WNJ1091

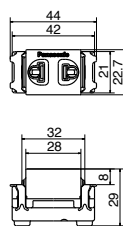

WNTJ15649

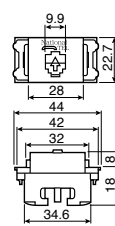

NRJ3160

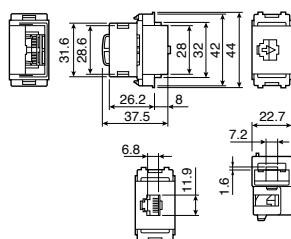

NRJ3170

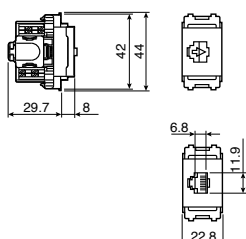

WZJ1201

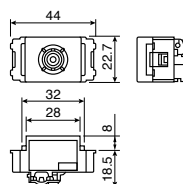

WNJ3020

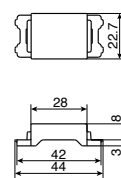

HOTEL ACCESSORIES

ALPHA CUBE

FLOOR OUTLET SERIES

PASSIVE INFRARED SENSOR

AUTOMATIC TIME SWITCH

D I M E N S I

Unit : mm

WNJ6801

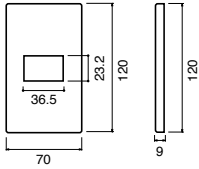

WNJ6802

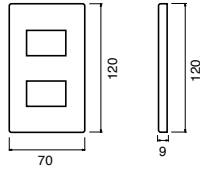

WNJ6803

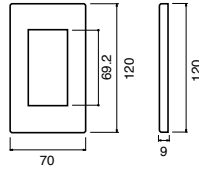

WZJ1781

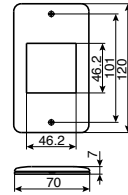

WNJ6891

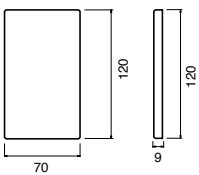

WNJ6804

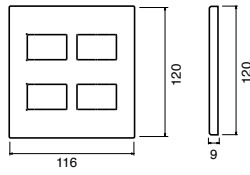

WNJ6806

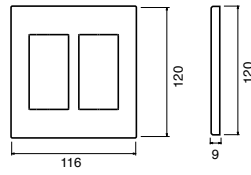

WNJ6009

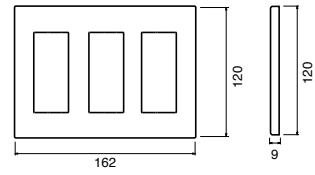

WNJ6012

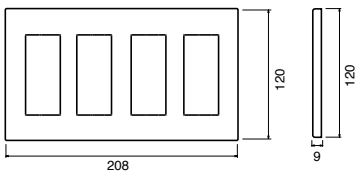

WNJ6015

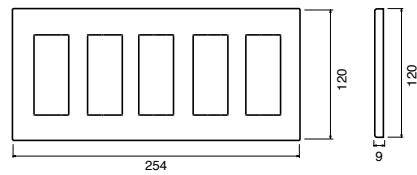

COMMON (WIDE, STYLEE, A'MODE)

Unit : mm

WEJ10919

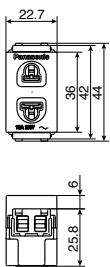

WEJ57515

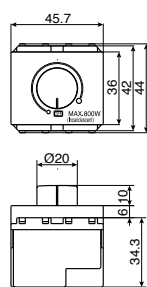

WEJ57518

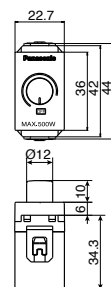

WEJ5401-7

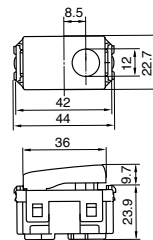

WEJ2164

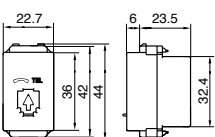

WEJ2166

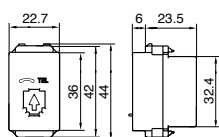

WEJ2488
WEJ24886

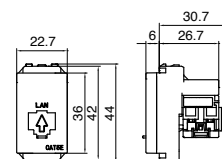

WEJ2501

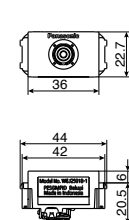

WEJ3020

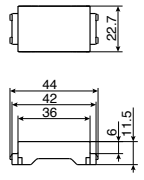

WEF1172W

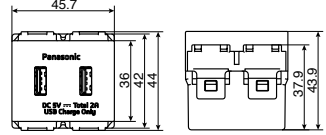

WEB1051W

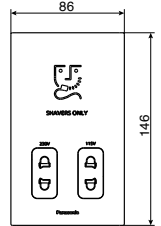

WEG3032G-031P

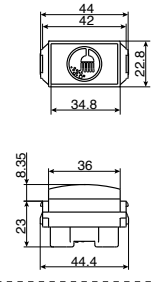

WEG2021

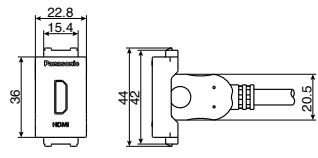

HOTEL ACCESSORIES (Hotel Room Wiring Diagram)

DND / MMR and Keycard

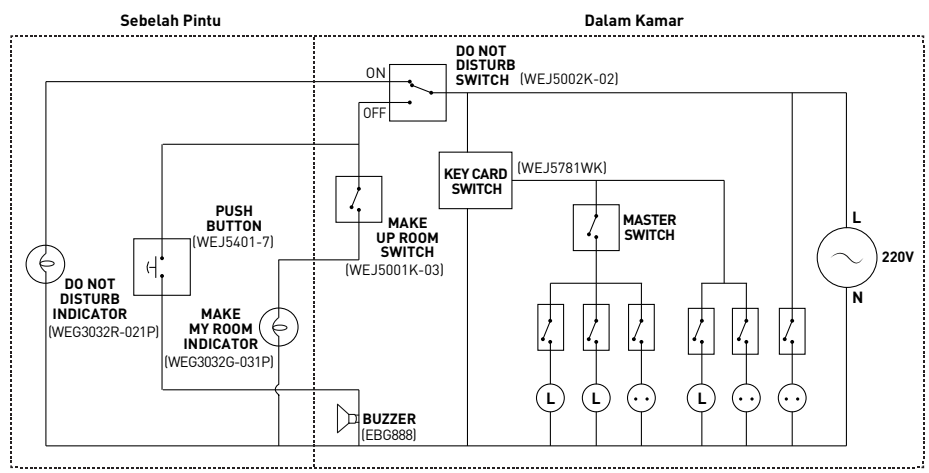

Keindahan dan Keamanan untuk Kemudahan

FLOOR OUTLET SERIES

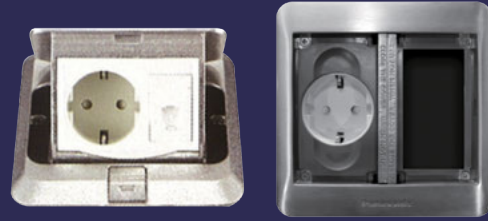

Kami menawarkan berbagai macam tipe produk untuk tiap ruang.

1) Aman

Dilengkapi dengan penutup yang tidak mudah terbuka bila terinjak saat tidak digunakan. Tetap kokoh dan stabil, bahkan bila terinjak saat produk sedang dalam posisi terbuka / digunakan

2) Tahan Lama

Telah melalui uji coba buka tutup penutup lebih dari 10.000 kali untuk menjamin kekuatan dan ketahanan.

3) Desain

Desain apik yang mudah menyesuaikan dengan ruang yang ada.

4) Lokasi yang Direkomendasikan

Shopping Mall



Office/Meeting Room



Training Gym



Cafe



Hotel



Class Room



Pemasangan

Pop Up Duplex Type

Setelah lantai beton terpasang, buatlah lubang untuk memasang produk.

(1) Buat lubang dengan menggunakan palu pada bagian tengah dimana unit akan dipasang

(2) Setelah lantai terlepas, maka kendurkan sekrup unit penutup dan lepaskan kotak pelindung.

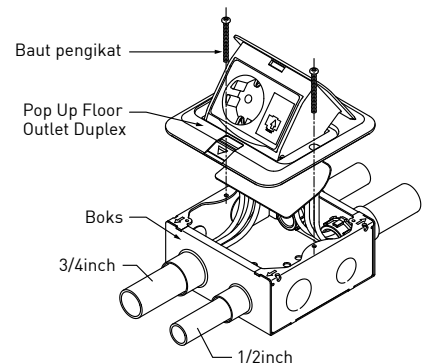
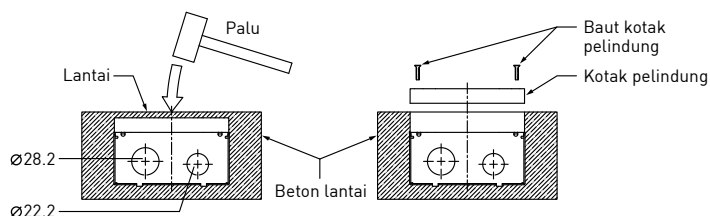

POP UP DUPLEX TYPE

Mudah dicolok sebagai sumber listrik sementara

Lokasi yang Direkomendasikan



Keterangan Produk

- IP:44
- Ketebalan:7.6mm
- Kedalaman:69.0mm

DU5913JTK-1

Stop Kontak Schuko dengan Grounding [CP] + Modul Telepon [6P4C]



DU5915JTK-1

Stop Kontak Schuko dengan Grounding [CP] + Modul Data CAT5E [8P8C]



DU5919JTK-1

Stop Kontak Schuko dengan Grounding [CP] + Chip Kosong



DU6955JTK-1

Modul Data CAT5E [8P8C] Ganda



DU6933JTK-1

Modul Telepon [6P4C] Ganda



DU6935JTK-1

Modul Telepon [6P4C] + Modul Data CAT5E [8P8C]



Ukuran

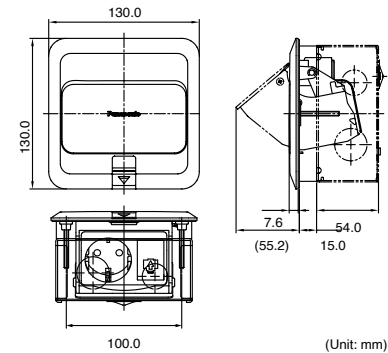

DOUBLE DUPLEX TYPE

Muat hingga 6 modul

Lokasi yang Direkomendasikan



Keterangan Produk

- IP:44
- Ketebalan:6.6mm
- Kedalaman:58.0mm

DUMF3233J

Stop Kontak Schuko dengan Grounding [CP] Ganda



DUMF3230J

Stop Kontak Schuko dengan Grounding [CP] + Blank [Max 3 devices (WIDE series module)]



DUMF3200J

Blank + Blank [Max 6 devices (WIDE series module)]



Ukuran

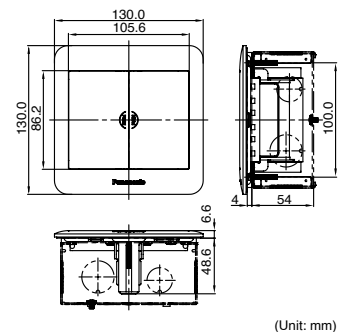

Double Duplex Type

Bagian permukaan cover pelindung harus sejajar dengan permukaan lantai.

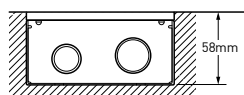

Pukul cover pelindung dengan palu dan lepaskan baut.

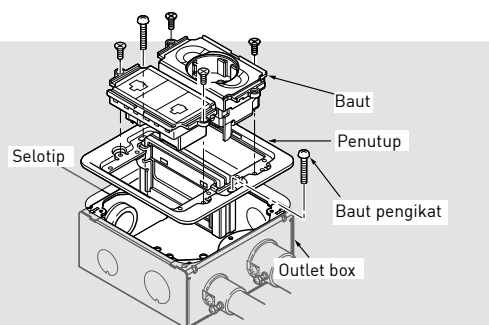
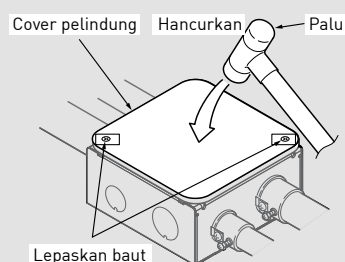

Inovasi Baru
Pengaturan Lampu yang Hemat Energi

PASSIVE INFRARED SENSOR



Pengaplikasian nirkontak yang sesuai untuk menghemat energi. Mendeteksi gerakan manusia dan otomatis.

Ilustrasi

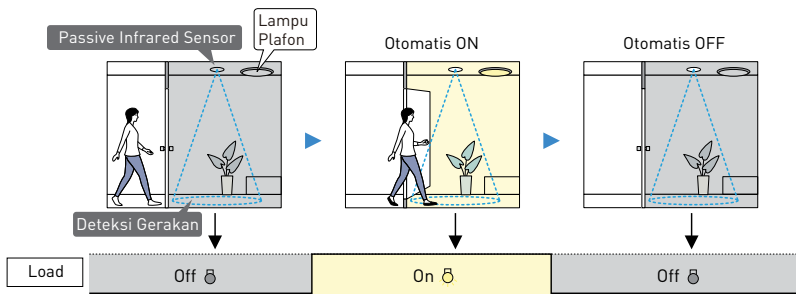

Rekomendasi Pemasangan



Toilet



Hall Pintu Masuk



Loker

Fitur

Nirkontak

Passive Infrared Sensor mengurangi resiko terkena kuman melalui kontak karena sensor bekerja menyalakan lampu ON/OFF secara otomatis di ruang umum seperti toilet atau ruang rapat.

Aman

Passive Infrared Sensor menyalakan lampu ON/OFF secara otomatis sehingga para pengguna tidak perlu mencari-cari tombol sakelar di area gelap. Hal ini mengurangi resiko lansia dan anak-anak tersandung.

Hemat Energi

Passive Infrared Sensor menyalakan lampu ON/OFF secara otomatis sehingga tidak ada energi terbuang ketika ruangan kosong.



Passive Infrared Sensor Memberikan Tingkat Sensitivitas dan Keandalan yang Tinggi. Mampu mendeteksi gerakan ketika terjadi perbedaan temperature antara temperature ruang dengan temperature obyek.

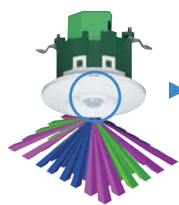

Zona dengan Tingkat Kepadatan Tinggi

Made in JAPAN

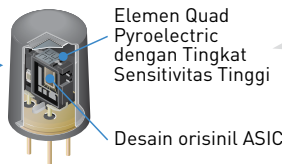

PaPIRs PIR Sensor

• Tingkat Sensitivitas 2X Lebih Baik

-Desain bercelah yang lebih baik dibandingkan sensor konvensional

• Deteksi ke Seluruh Penjurur Ruang

-Dengan elemen quad yang meningkatkan kemampuan deteksi sensor ke seluruh penjurur ruang

• 4K Lebih Baik Memberikan Sinyal Alarm

-Desain orisinal ASIC dapat mengurangi kemungkinan timbulnya alarm palsu
-Pengaturan deteksi pada ASIC yang handal

PIR Konvensional

-Dual element

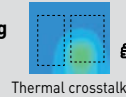

Thermal crosstalk

PaPIRs element

- Quad element with slit design



4way direction detection

PaPIRs

Konvensional

PIR Sensor



Lensa Adjustable

Mampu menyesuaikan area deteksi hingga 15°. Memungkinkan untuk mengganti area yang terdeteksi setelah instalasi selesai.

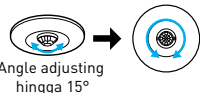

Angle adjusting hingga 15°

Rotasi lensa hingga 360°

Ketika Tidak Dapat Diinstal Pada Posisi yang Diinginkan

Ketika sensor tidak dapat diinstal karena ada lighting atau fire alarm



Up to 15°

Ketika Mengganti Cakupan Area Deteksi

Ketika mengganti cakupan area deteksi seiring dengan mendekati / menjauhi sensor.

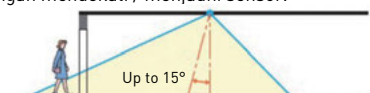

Up to 15°



Quick Connect Terminal II
 Solid Wire : 1.5-2.5mm²
 Stranded Wire : 1.5-2.5mm²

■ PaPIRs installed model
Stand-alone Type
Tipe Pemasangan Permukaan Plafon

Professional Use

WTKG2310-P

Passive Infrared Sensor
 (Tipe Pemasangan Permukaan Plafon)
 3A 220V-240V-
 1 min. Waktu Tunda



WTKJ2311

Passive Infrared Sensor
 (Tipe Pemasangan Permukaan Plafon)
 3A 220V-240V- 10 sec. - 30 min.
 Waktu Tunda / Sensor Cahaya



Spesifikasi

Model no.	WTKG2310-P	WTKJ2311
Jangkauan Sensor		
Lensa Adjustable	<p>Tekan sensor dengan lembut dan putar (15°oblique; 360°turn around)</p>	<p>Tekan sensor dengan lembut dan putar (15°oblique; 360°turn around)</p>
Ukuran		
Rating	3A 220-240V-	
Konsumsi Energi	Kurang dari 2W	
Kapasitas	Lampu Pijar 660W Lampu CFL 330W Lampu LED 330W	
Standar Aplikasi	IEC60669 - 2 - 1	
Temperatur	-10°C to +40°C	
Koneksi Pengkabelan	Quick Connect Terminal II	
Ukuran Lubang Instalasi (cm)	7.0 (+0.5)	
Jenis Kabel yang Dapat Digunakan	1.5mm ² - 2.5mm ² Kabel Tembaga	
Jenis Kotak yang Dapat Digunakan	Kotak Persegi	1.5 inci lebih
	Kotak Oktagon	1.5 inci lebih
Penundaan Time-Out	tetap 1 menit	Dapat disesuaikan 10 detik ~ 30 menit
Pergerakan yang Dapat Terdeteksi	0.3m/s ~ 1.0m/s	

HOTEL ACCESSORIES

ALPHA CUBE

FLOOR OUTLET SERIES

PASSIVE INFRARED SENSOR

AUTOMATIC TIME SWITCH

Tersedia dalam berbagai model yang dapat menyesuaikan dengan kondisi dan iklim yang ada.

AUTOMATIC TIME SWITCH



Apa itu Time Switch Otomatis?

Merupakan perangkat elektrikal yang secara otomatis mengatur penggunaan listrik berdasarkan waktu yang telah ditentukan. Alat ini dapat menekan biaya listrik serta upah tenaga kerja.

Secara Otomatis Menyalakan dan Mematikan Energi

Mengkombinasikan jam dengan sakelar, Time Switch dapat mengatur nyala dan matinya suplai listrik berdasarkan waktu yang sudah ditentukan. Umumnya Time Switch dipasang pada panel distribusi atau lightboard, dan mengontrol alat elektrikal dalam periode 24 jam. Alat ini dapat menggantikan kontrol listrik yang manual dan konvensional dengan pengaturan waktu yang otomatis dan dapat diandalkan.

Penghematan Energi Listrik

Karena suplai listrik telah diatur berdasarkan waktu yang telah ditentukan, maka dapat menciptakan terjadinya penghematan energi listrik, sehingga biaya tagihan listrik pun lebih rendah.

Efisiensi Tenaga Kerja

Dengan adanya pengaturan otomatis atas suplai listrik, maka sumber daya pekerja pun dapat dialihkan untuk melakukan pekerjaan yang lebih penting. Sebagai tambahan, manajemen sumber daya energi pun lebih dapat diandalkan karena berkurangnya human error.

Pengaturan Waktu On/Off yang Mudah

Manajemen waktu untuk pengaturan On/Off suplai listrik menjadi sangat mudah. Variasi penggunaannya sangat banyak di berbagai macam operasi, seperti pengaturan lampu, AC, suplai dan dan pengaturan makan hewan ternak.

Contoh: Pengaturan Listrik di Kantor

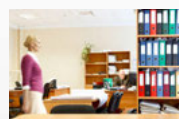

Dari Pk 1 siang sampai dengan 6 sore
Seluruh lampu dan AC dinyalakan tepat pada saat makan siang berakhir. Setelah itu seluruh energi listrik otomatis mati ketika jam kerja berakhir.

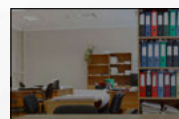

Dari pk 12 malam hingga 1 siang
Seluruh lampu dan AC dimatikan sewaktu makan siang. Tidak ada energi listrik yang terbuang percuma.



Dari pk 06.30 pagi hingga jam 12 siang
Seluruh lampu dan AC dinyalakan secara otomatis, guna memastikan suasana bekerja yang nyaman



Contoh Penggunaan

1 Penggunaan di Pabrik

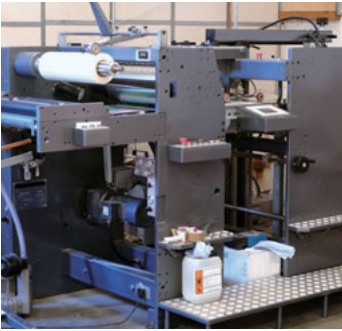

Aktivasi Fasilitas Pabrik

Beberapa mesin seperti mesin injeksi perlu dipanaskan sebelum digunakan sewaktu operasional. Hal ini dapat dilakukan dengan menggunakan time switch pada mesin-mesin tersebut.

An example of time chart

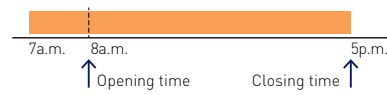

Recommend Model



TB38809NE7

TB438NE7

2 Penggunaan di Kantor, Residensial serta Gedung Komersil



Pengaturan Lampu dan AC

Pengaturan On/Off lampu serta AC dapat dilakukan melalui Time Switch, berdasarkan jam operasional.

An example of time chart

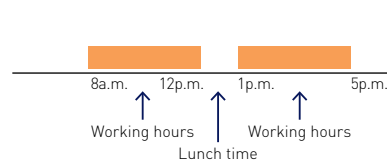

Recommend Model



TB38809NE7

TB118NE7

3 Penggunaan di Pertanian dan Peternakan



Pengaturan lampu, suplai makanan dan minuman pada pertanian dan peternakan.

Time Switch dapat digunakan untuk secara otomatis mengatur pencahayaan di peternakan untuk memperbaiki produk telur, serta mengatur suplai makanan dan minuman sesuai waktu yang tepat.

An example of time chart

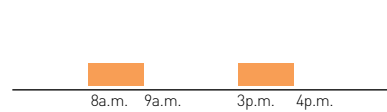

Recommend Model



TB388NE7

TB118NE7

4 Penggunaan di Vila dan Rumah



Pompa Kolam (Penjernihan Air)

Time Switch dapat digunakan untuk mengatur pengoperasian penjernihan air di rumah dan kolam renang.

An example of time chart

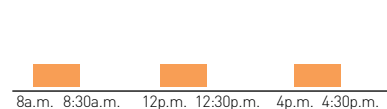

Recommend Model



TB38809NE7

TB118NE7

Please contact...

<https://panasonic.net/pglssid/>

PT. Panasonic Gobel Life Solutions Sales Indonesia

Summitmas I Building, 8th Floor

Jl. Jend. Sudirman Kav. 61-62, Jakarta 12190 - Indonesia



Manufactured by

PT. Panasonic Gobel Life Solutions Manufacturing Indonesia

Bogor Factory : Kawasan Industri Menara Permai,
Jl. Raya Naragong 8 No. Km 23, Bogor - Jawa Barat 16820

Pasuruan Factory : Kawasan Pasuruan Industrial Estate Rembang,
Jl. Rembang Industri Raya No. 47 PIER,
Pasuruan - Jawa Timur 67152

Panasonic[®]