



AMP NETCONNECT Product Catalog



Visit our website at www.ampnetconnect.com

- :: Instruction Sheets
- :: Data Sheets
- :: AMP NETCONNECT Product Sales Engineer Contacts
- :: Authorized NETCONNECT Design and Installation (ND&I) Contractor Listings
- :: Authorized AMP NETCONNECT Product Distributor Listings
- :: Cut Sheets
- :: Product/Part Number Searches
- :: White Papers



Or contact AMP NETCONNECT business unit by phone or e-mail

Customer Service Center (USA):

1-800-553-0938

- Technical Support
- Place an Order
- Tyco Electronics Fax Service
- Product Information
- Product Samples
- Obtain a Quote
- Order Literature

AMP NETCONNECT Product Training Services:

1-800-331-9857 ext 63809

- :: Installing and Connectorizing LAN Cabling
- :: Certifying and Troubleshooting LAN Cabling
- :: Designing LAN Cabling

To contact AMP NETCONNECT Business Unit via e-mail:

networking.help@tycoelectronics.com



Globally connected for all your cabling needs

Americas

Argentina	54-11-4733-2200
Brazil	55-11-2103-6120
Brazil	55-11-2103-6104
Canada	905-475-6222
Chile	56-2-3450300
Columbia	57-1-2544444
Mexico	52-55-11060800
Peru	51-1-442-4242
United States	800-553-0938
Venezuela	57-1-2544444

Asia/Pacific

Australia	
Sydney	61-2-9638-8128
Melbourne	61-3-9558-8066
China	86-21-96999267
Hong Kong	852-2738-3466
Indonesia	6221-526-7852
Japan	
Kawasaki	81-44-844-8071
Osaka	81-6-6533-8240
Korea	82-2-3415-4551
Malaysia	603-7805-3055
New Zealand	
Auckland	64-9-634-4580

Wellington	64-4-3841495
Philippines	63-2-848-0171
Singapore	65-6416-4595
Taiwan	886-2-8768-2788
Thailand	66-2-955-0500
Vietnam	84-903-016694

Europe, Middle East and Africa (EMEA)

Austria	43-1-90560-0
Belgium	32-16-352-300
Bulgaria	359-2-971-2152
Czech Republic	420-5-41-162-112
Denmark	45-70-15-52-00
Egypt	202-417-76-47
Finland	358-95-1234-20
France	33-1-3420-2122
Germany	49-6103-709-1547
Greece	30-210-9370-396/7
Hungary	36-1-289-1007
India	91-80-8412433
Ireland	353-1-820-3000
Italy	39-011-4012-111
Lithuania	370-5-213-1402
Netherlands	31-73-6246-211
Norway	47-66-77-88-99
Poland	48-22-4576-700

Portugal	34-93-291-0330
Romania	40-21-311-3479
Russia	
Moscow	7-095-926-5509
St. Petersburg	7-812-118-8192
Slovakia	420-5-41-162-112
Slovenia	386-1561-3270
South Africa	27-11-466-2999
Spain	34-93-291-0330
Sweden	46-8-5072-5000
Switzerland	41-71-447-0447
Turkey	90-212-281-8181
United Arab Emirates	971-4-339-1199
Ukraine	380-44-238-6908
United Kingdom	44-208-420-8140

For Eastern European Countries not shown, call 49-6103-709-1166

For Middle East & African (MEA) Countries not shown, call 33-1-3420-2122

1	Twisted Pair Products	
1.1	Cable	4
1.2	Connectors, Couplers, and Adapters	11
1.3	Cable Assemblies	27
1.4	Patch Panels	33
1.5	Cross-Connect Systems.....	51
1.6	Data Center SAN.....	61
1.7	Tools	65
2	Optical Fiber Products	
2.1	Cable	76
2.2	Connectors, Couplers, and Adapters	89
2.3	Cable Assemblies	103
2.4	Data Center SAN	113
2.5	Rack Mount Enclosures and Accessories	119
2.6	Wall Mount Enclosures and Accessories.....	129
2.7	Tools	135
3	Outlets, Faceplates, and Accessories	149
	Consolidation Points and Accessories	195
4	SECURE System Products	201
5	Cabletray, Vertical and Horizontal Rack Management	213
6	AMPTRAC Connectivity Management System	229
7	LAN Electronics	243
8	Labeling & Identification	253
9	ETHERSEAL Connectivity System	261
10	Power Distribution	269
11	AMP NETCONNECT HOME NET-WORKS SYSTEM	275
12	System Layouts	293

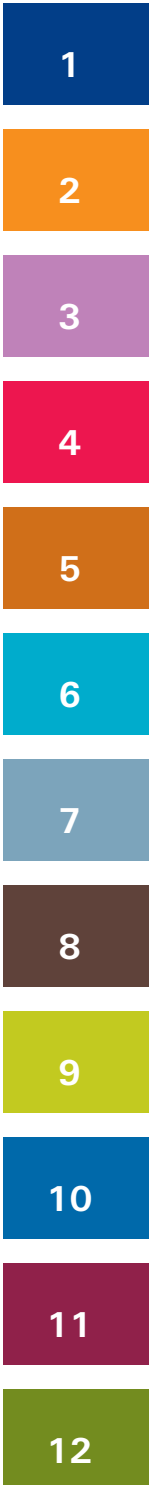

25 Year System Performance Coverage



We are confident that your AMP NETCONNECT cabling system will keep performing to current TIA/EIA 568B industry standards. If it ever fails to meet those standards within 25 years of the date of installation, we'll provide the reasonable parts and labor to replace or repair the AMP NETCONNECT product.*

25 Year Component Coverage



Tyco Electronics also offers a 25 Year Component Warranty to protect individual AMP NETCONNECT cabling system components. If a component fails within 25 years of the date of installation, we'll provide the reasonable parts to replace or repair the registered AMP NETCONNECT product.*

It's Standard Equipment

This coverage is automatically part of the package when you specify AMP NETCONNECT products end-to-end and when a Tyco Electronics-authorized NETCONNECT Design & Installation (ND&I) contractor registers the network project with Tyco Electronics and performs the actual installation in accordance with Tyco Electronics requirements.*

Who's Covered

Unlike most system suppliers, Tyco Electronics provides warranty coverage directly to the end user. Many suppliers provide coverage to the installers, who then provide coverage to the customers. But with the Tyco Electronics warranties, there are no middlemen. The warranties are between you and Tyco Electronics.

*Some conditions may apply. AMP NETCONNECT Home Net-Works Systems qualify for a 25 year component warranty only. For more information, please visit www.ampnetconnect.com or call 1-800-553-0938. Outside the U.S., please contact your local AMP NETCONNECT product sales office.

TWISTED PAIR PRODUCTS

1.1 Twisted Pair Cables	4-10
1.2 Connectors, Couplers & Adapters	11-26
1.3 Twisted Pair Cable Assemblies	27-32
1.4 Twisted Pair Patch Panels	33-50
1.5 Cross-Connect Systems	51-60
1.6 DATA Center/SAN Products	61-64
1.7 Twisted Pair Tools	65-73

1.1

1.1

Twisted Pair Products



TWISTED PAIR CABLE

Category 6 Cable	5
Category 6A Cable	5
Category 6E Cable	6
Category 5e Cable	7-8
Category 5E (350 MHz) Cable	8
Category 5 Cable	9

Chapter Summary

- Meet or exceed all TIA/EIA and ISO specifications
- Listed for safety (CMR/CMP)
- Category 5, Category 5e, Category 6, and Category 6A performance
- Variety of colors and packaging available

3

Twisted Pair Cable Information

1.1

UTP Cable Packaging



WR = Wooden Reels



RB = Reel-in-a-Box



PB = Pull Box

Note: Unless otherwise specified, all lengths are 1000 feet (305 meters).
Other lengths and colors available. Call for details. Package types are listed in each chart.

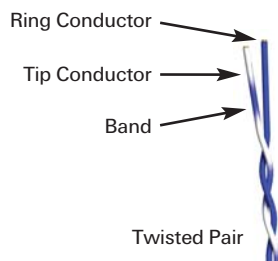

4-Pair Conductor Color Code

Pair	Tip	Ring	Jacket Color
1	Tip	Ring	White Blue
	Tip	Ring	White Orange
2	Tip	Ring	White Green
	Tip	Ring	White Brown

25-Pair Conductor Color Code

Color Group	Pair	Tip	Ring	Conductor Jacket Color	Band Color
White	1	Tip	Ring	White Blue	Blue White
		Tip	Ring	White Orange	Orange White
	2	Tip	Ring	White Green	Green White
		Tip	Ring	White Brown	Brown White
	3	Tip	Ring	White Slate	Slate White
		Tip	Ring	Red Blue	Blue Red
	4	Tip	Ring	Red Orange	Orange Red
		Tip	Ring	Red Green	Green Red
	5	Tip	Ring	Red Brown	Brown Red
		Tip	Ring	Red Slate	Slate Red
Red	1	Tip	Ring	Black Blue	Blue Black
		Tip	Ring	Black Orange	Orange Black
	2	Tip	Ring	Black Green	Green Black
		Tip	Ring	Black Brown	Brown Black
	3	Tip	Ring	Black Slate	Slate Black
		Tip	Ring	Yellow Blue	Blue Yellow
	4	Tip	Ring	Yellow Orange	Orange Yellow
		Tip	Ring	Yellow Green	Green Yellow
	5	Tip	Ring	Yellow Brown	Brown Yellow
		Tip	Ring	Yellow Slate	Slate Yellow
Yellow	1	Tip	Ring	Violet Blue	Blue Violet
		Tip	Ring	Violet Orange	Orange Violet
	2	Tip	Ring	Violet Green	Green Violet
		Tip	Ring	Violet Brown	Brown Violet
	3	Tip	Ring	Violet Slate	Slate Violet
		Tip	Ring	Orange Slate	Slate Orange
	4	Tip	Ring	Orange Violet	Violet Orange
		Tip	Ring	Orange Green	Green Violet
	5	Tip	Ring	Orange Brown	Brown Violet
		Tip	Ring	Orange Slate	Slate Violet

Twisted Pair Cable Temperature Ranges

Category		Riser/Plenum
5, 5e, 6, 6E, 6A	Storage	-4 – 140°F (-20 – 60°C)
	Operating	-4 – 140°F (-20 – 60°C)
	Installation	40 – 140°F (4 – 60°C)

Twisted Pair Cable Standards Information

TIA/EIA Category	ISO/IEC Class	ANSI/TIA/EIA Standard	ISO/IEC Standard	Frequency* MHz	Common IEEE or TIA/EIA Applications	Number of Pairs Used	Bandwidth Mbps
5	D	568-A	11801:1999	100	802.5 - Token Ring	2	4;16;100
					802.3 - 10BASE-T Ethernet	2	10
					802.3 - 100BASE-T Ethernet	2	100
5e	D	568-B	11801:2002	100	802.5 - Token Ring	2	4;16;100
					802.3 - 10BASE-T Ethernet	2	10
					802.3 - 100BASE-T Ethernet	2	100
6	E	568-B	11801:2002	250	802.3 - 1000BASE-T Ethernet	4	1000
					EIA-854 - 1000BASE-Tx Ethernet	4	1000
					802.5 - Token Ring	2	4;16;100
6A	Ea	568-B.2-10	11801:Ed. 2.1	500	802.3 - 10BASE-T Ethernet	2	10
					802.3 - 100BASE-T Ethernet	2	100
					802.3 - 1000BASE-T Ethernet	4	1000
					EIA-854 - 1000BASE-Tx Ethernet	4	1000
					802.3an 10 Gig Ethernet	4	10 Gig

*Note: Frequency refers to maximum frequency that cabling is characterized to.

4

Category 6 UTP Cable



Product Facts

- Meets or exceeds TIA/EIA-568-B Category 6 and ISO Class E 11801: 2002 specifications
- Performance characterized to 600 MHz
- 3 dB NEXT performance above Category 6
- Independently verified by Intertek ETL SEMKO testing services
- Exceeds all requirements for Gigabit Ethernet
- Lead-free (no heavy metals)
- 23 AWG, solid conductors



UL/NEC Ratings	Pair Count	Package	Part Number				Weight lbs/kft	Vp (%nom)	Dimensions (in)	
			White	Gray	Blue	Yellow			Dielectric	Outside
CMR	4	RB	219560-2	219560-4	219560-6	219560-8	26	70	0.042	0.230
		WR	219560-1	219560-3	219560-5	219560-7				
CMP	4	RB	219567-2	219567-4	219567-6	219567-8	24	74	0.040	0.206
		WR	219567-1	219567-3	219567-5	219567-7				

Category 6A F/UTP (ScTP) Cable

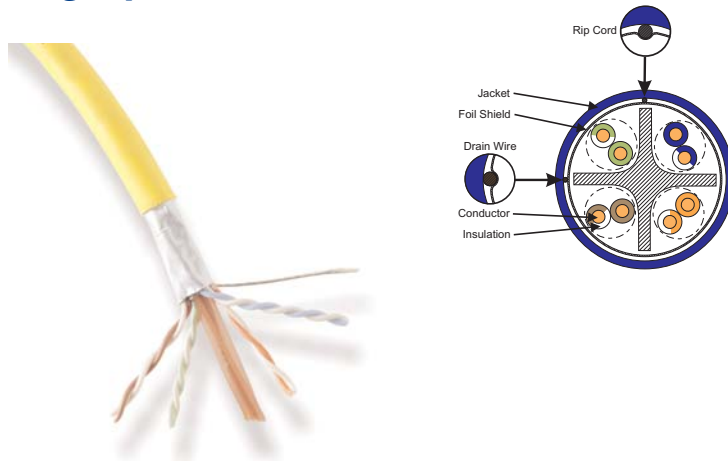

Product Facts

- Meets or exceeds TIA/EIA-568-B.2-10 Augmented Category 6 and ISO 11801 Edition 2.1 Class E_A specifications
- Independently verified by Intertek ETL SEMKO third party testing services
- Exceeds all requirements for IEEE 802.3an 10 Gigabit Ethernet
- 23 AWG solid conductors
- Lead-free (no heavy metals)



UL/NEC Ratings	Pair Count	Package	Part Number				Weight lbs/mft	Vp (%nom)	Dimensions (in)	
			White	Gray	Blue	Yellow			Dielectric	Outside
CMR	4	WR	4-1499389-1	4-1499389-3	4-1499389-5	4-1499389-7	41.0	72	0.044	0.300
CMP	4	WR	4-1499416-1	4-1499416-3	4-1499416-5	4-1499416-7	41.7	72	0.044	0.300

Category 6E UTP Cables

1.1

Category 6E UTP Cable

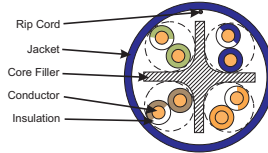
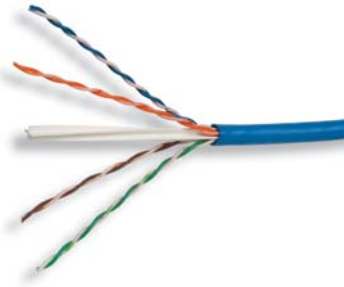

Product Facts

- Meets or exceeds TIA/EIA-568-B Category 6 and ISO 11801: 2002 Class E specifications
- Performance characterized to 600 MHz
- 8 dB NEXT performance above Category 6
- Intertek ETL SEMKO Listed (CMR/CMP)
- Independently verified by Intertek ETL SEMKO testing services
- Exceeds all requirements for Gigabit Ethernet
- Lead-free (no heavy metals)
- 23 AWG, solid conductors



UL/NEC Ratings	Pair Count	Package	Part Number				Weight lbs/kft	Vp (%nom)	Dimensions (in)	
			White	Gray	Blue	Yellow			Dielectric	Outside
CMR	4	RB	1499038-2	1499038-4	1499038-6	1499038-8	34	70	0.042	0.260
		WR	1499038-1	1499038-3	1499038-5	1499038-7				
CMP	4	RB	1499033-2	1499033-4	1499033-6	1499033-8	35	74	0.040	0.260
		WR	1499033-1	1499033-3	1499033-5	1499033-7				

6

Category 5e UTP Cable (200 MHz)

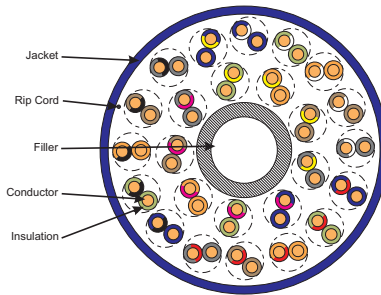
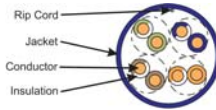

Product Facts

- 4-Pair Cable:
 - Meets or exceeds TIA/EIA-568-B Enhanced Category 5 and ISO 11801: 2002 Class D specifications
 - Independently verified by Intertek ETL SEMKO testing services
 - Performance characterized to 200 MHz
 - 2 dB NEXT performance above Category 5e
 - UL & cUL Listed (CMR/CMP)
 - Meets or exceeds all requirements for Gigabit Ethernet
- 25-Pair Cable:
 - Meets or exceeds TIA/EIA-568-B Enhanced Category 5 and ISO 11801: 2002 Class D specifications
 - Independently verified by Intertek ETL SEMKO testing services
 - UL & cUL Listed (CMR/CMP)
 - 24 AWG, solid conductors
 - Lead-free (no heavy metals)



UL/NEC Ratings	Pair Count	Package	Part Number				Weight lbs/kft	Vp (%nom)	Dimensions (in)	
			White	Gray	Blue	Yellow			Dielectric	Outside
CMR	4	RB	219538-2	219538-4	219538-6	219538-8	24	70	0.037	0.20
		WR	219538-1	219538-3	219538-5	219538-7				
		PB	6-219538-2	6-219538-4	6-219538-6	6-219538-8				
CMR	25	WR	1499418-1	1499418-2	1499418-3	1499418-4	134	69	0.032	0.50
		RB	219513-2	219513-4	219513-6	219513-8				
		WR	219513-1	219513-3	219513-5	219513-7				
CMP	4	WR	219513-1	219513-3	219513-5	219513-7	22	74	0.035	0.19
		PB	6-219513-2	6-219513-4	6-219513-6	6-219513-8				
		WR	1499419-1	1499419-2	1499419-3	1499419-4				
CMP	25	WR	1499419-1	1499419-2	1499419-3	1499419-4	142	72	0.037	0.46

Category 5E F/UTP & 5E UTP Cables

1.1

Category 5e F/UTP Cable

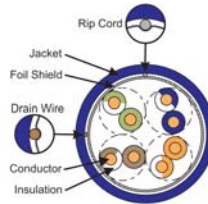
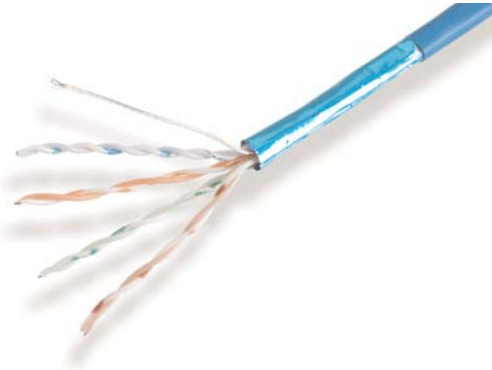

Product Facts

- Meets or exceeds TIA/EIA-568-B Enhanced Category 5 and ISO 11801: 2002 Class D specifications
- Independently verified by Intertek ETL SEMKO testing services
- UL & cUL Listed (CMR/CMP)
- Exceeds all requirements for Gigabit Ethernet
- 24 AWG, solid conductors
- Lead-free (no heavy metals)



UL/NEC Ratings	Pair Count	Package	Part Number				Weight lbs/kft	Vp (%nom)	Dimensions (in)	
			White	Gray	Blue	Violet			Dielectric	Outside
CMR	4	WR	1499171-1	1499171-3	1499171-5	1-1499171-7	31	72	0.041	0.240
CMP	4	WR	1499172-1	1499172-3	1499172-5	-	29	72	0.042	0.219

Category 5E UTP Cable (350 MHz)

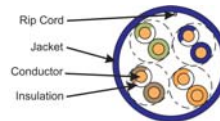

Product Facts

- Meets or exceeds TIA/EIA-568-B Enhanced Category 5 and ISO Class D 11801:2002 specifications
- Independently verified by Intertek ETL SEMKO testing services
- Performance characterized to 350 MHz
- 5 dB NEXT performance above Category 5E
- UL & cUL listed (CMR/CMP)
- Gigabit Ethernet zero bit error rate independently certified by Intertek ETL SEMKO testing services
- Lead-free (no heavy metals)
- 24 AWG, solid conductors



UL/NEC Ratings	Pair Count	Package	Part Number				Weight lb/kft	Vp (%nom)	Dimension (in)	
			White	Gray	Blue	Yellow			Dielectric	Outside
CMR	4	RB	57826-2	57826-4	57826-6	57826-8	24	70	0.037	0.20
		WR	57826-1	57826-3	57826-5	57826-7				
		PB	6-57826-2	6-57826-4	6-57826-6	6-57826-8				
CMP	4	RB	57825-2	57825-4	57825-6	57825-8	22	74	0.035	0.19
		WR	57825-1	57825-3	57825-5	57825-7				
		PB	6-57825-2	6-57825-4	6-57825-6	6-57825-8				

8

Category 5 UTP Cable

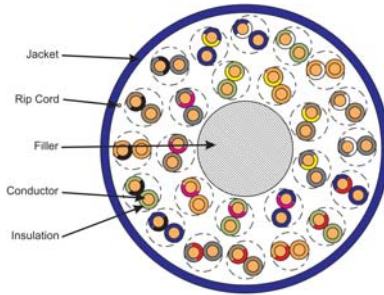

Product Facts

- Meets or exceeds all TIA/EIA-568-A Category 5 and ISO 11801 Class D requirements
- UL & cUL Listed (CMR/CMP)
- Independently verified by Intertek ETL SEMKO testing services
- Lead-free (no heavy metals)
- 24 AWG, solid conductors



UL/NEC Ratings	Pair Count	Package	Part Number				Weight lb/kft	Vp (%nom)	Dimensions (in)	
			White	Gray	Blue	Yellow			Dielectric	Outside
CMR	25	WR	57814-1	57814-2	57814-3	57814-4	124	69	0.039	0.48
CMP	25	WR	57815-1	57815-2	57815-3	57815-4	124	72	0.037	0.41

1.1

10

CONNECTORS, COUPLERS, AND ADAPTERS

Modular Jacks 12-16
 SL Series Modular Jacks 13-15
 SL Series Toolless Modular Jacks 15
 110Connect Modular Jacks and Accessories 16
 Modular Pair Couplers 17
 Multimedia Jacks and Inserts 18-19
 SL Series Multimedia Jacks 18
 SVGA Assembly 18
 SL Series Multimedia Inserts 19
 Modular Plugs 20-25
 Category 6 Modular Plugs and Accessories 20
 Category 5e Modular Plugs 21
 Category 3 Modular Plugs 21
 Category 3, 5 and 5e Modular Plug Accessories 22
 110Connect XC Patch Plugs 22
 CHAMP Category 3 25-Pair Plugs and Accessories 23
 Filters, Baluns & Adapters 24-25

Chapter Summary

- High density solutions with front-loadable modularity
- Individual jacks and inserts increase configuration and color-coding options
- Tyco Electronics offers one of the broadest assortments of connectors in the world and is continually introducing new products. If you don't see what you need in this catalog, please contact Tyco Electronics Product Information Center at 1-800-522-6752

1.2



Twisted Pair Connectivity Information

1.2

Suggested Modular Jack Cutouts

SL Series and 110Connect

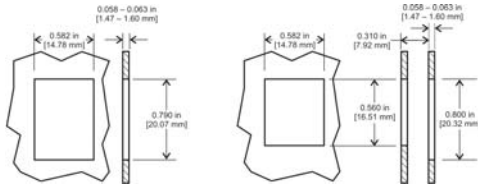

Suggested Single Panel Cutout

Suggested Flush Mount Panel Application Cutout

Modular Couplers

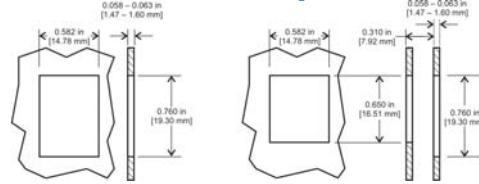

Suggested Single Panel Cutout

Suggested Flush Mount Panel Application Cutout

AMP NETCONNECT Modular Jack Technical Reference

Modular Jack Mating Cycles	110 Contacts Terminations	Modular Jack Pull Force	Voltage	Operating Temperature	Approvals
750	200	20 lbs (89 N)	150 VAC max.	-40° – 70°C (-40° – 158°F)	UL Listed File Number: E81956



Die Set/Tool to Modular Plug Cross-Reference

Modular Plug	Modular Plug Tool Kits			Individual Modular Plug Die Sets for Hand Tool 2-231652-0			
	790163-1	790163-5	1-231666-4	1-853400-0	853400-1	853400-7	853400-8
1479583	-	-	X	X	-	-	-
1479584	-	-	X	X	-	-	-
1479585	-	-	X	X	-	-	-
1479586	-	-	X	X	-	-	-
1479682	X	-	-	-	-	-	-
1479683	X	-	-	-	-	-	-
1479185	-	X	-	-	-	-	-
1479184	-	X	-	-	-	-	-
1375202	X	-	-	-	-	-	-
1375204	X	-	-	-	-	-	-
554169	-	-	X	-	X	-	-
554170	-	-	X	-	X	-	-
554710	-	-	X	-	-	-	X
554720	-	-	X	-	X	-	-
554739	-	-	X	-	X	-	-
555042	-	-	X	-	-	-	X
555174	-	-	X	-	-	X	-
555175	-	-	X	-	-	X	-
555177	-	-	X	-	-	X	-
555417	-	-	X	-	X	-	-
555426	-	-	X	-	-	X	-
557315	-	-	X	-	X	-	-
558530	-	-	X	X	-	-	-
569278	-	-	X	X	-	-	-
569550	-	-	X	X	-	-	-
569552	-	-	X	X	-	-	-
569530	-	-	X	-	X	-	-
569532	-	-	X	-	X	-	-
569542	-	-	X	-	-	-	X
641337	-	-	X	-	-	-	X

Application Wiring Diagrams for Modular Jacks

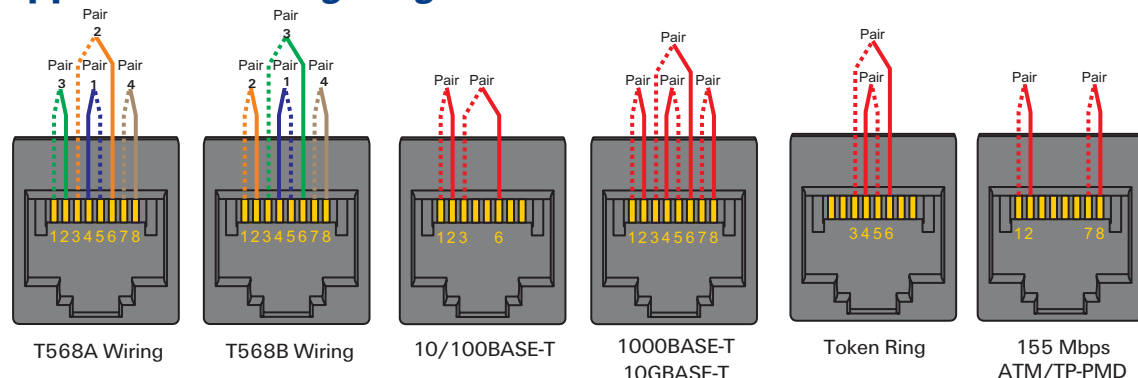

12

XG Category 6A AMP-TWIST Shielded Modular Jacks



Description	Wiring Pattern	Part Number
Cat 6A, Shielded	T568A/T568B	1711342-1
	with Dust Cover	1711160-1
Side Entry Cat 6A, Shielded	T568A/T568B	1711343-1
	with Dust Cover	1711295-1

Product Facts

- Meets or exceeds all TIA/EIA Category 6A performance standards
- Will allow 10GBASE-T (IEEE 802.3an) on 100 m channels
- Easy installation with only 2 parts
- Termination time: about 90 seconds (using AMP NETCONNECT SL Series Termination Tool, without Lacing Fixture-1725150-3 (see Chapter 1.7)
- Shield clamp
- Integrated strain relief
- Integrated dust cover option
- Re-usable
- Universal wiring label permits wiring to T568A or T568B
- 8-Position RJ45 Modular Jacks for 1-, 2-, 3-, and 4-Pair applications
- RoHS compliant

SL Series Category 6 Modular Jacks



Description	Wiring Pattern	Part Number	
Cat 6 Unshielded	T568A/T568B	1375055-X	
		Bulk Packaged - 25 Jacks	Y-1375055-Y
		With Dust Cover	1375187-X
Cat 6 Shielded	T568A/T568B	180° (Rear) Entry	1375188-1*
		90° (Side) Entry	1479552-1*

X denotes color: -1 = Almond, -2 = Black, -3 = White, -4 = Gray, -5 = Orange, -6 = Blue, -7 = Red, -8 = Yellow, -9 = Green, 1--0 = Violet, 1--1 = Electrical Ivory

Y denotes color and bulk package: 2- -1 = Almond, 2--2 = Black, 2--3 = White, 2--4 = Gray, 2--5 = Orange, 2--6 = Blue, 2--7 = Red, 2--8 = Yellow, 2--9 = Green, 3--0 = Violet, 3--1 = Electrical Ivory

*Note: Shielded jacks are not available in colors and do not accept strain reliefs.

Product Facts

- Thin profile improves outlet density
- Modular Jacks available with integral dust covers
- 180° or 90° cable dress for easy termination
- Universal wiring label permits wiring to T568A or T568B
- Meets or exceeds all TIA and ISO component performance requirements
- Bend-limiting strain relief included with unshielded jacks
- UL Listed: E81956
- 8-Position RJ45 Modular Jacks for 1-, 2-, 3- and 4-Pair applications
- Can be terminated with either SL Series Modular Jack Termination Tool (1725150-1 or standard 110 punch-down tools (see Chapter 1.7)
- RoHS compliant
- For RJ45 SECURE jacks, see Chapter 4

SL Series Modular Jacks

1.2

SL Series Category 5e Modular Jacks



Description	Wiring Pattern	Part Number
Cat 5e Unshielded	T568A/T568B	Bulk Packaged - 25 Jacks
		With Dust Cover
Cat 5e Shielded	T568A/T568B	180° (Rear) Entry
		90° (Side) Entry

X denotes color: -1 = Almond, -2 = Black, -3 = White, -4 = Gray, -5 = Orange, -6 = Blue, -7 = Red, -8 = Yellow, -9 = Green, 1--0 = Violet, 1--1 = Electrical Ivory

Y denotes color and bulk package: 2- -1 = Almond, 2- -2 = Black, 2- -3 = White, 2- -4 = Gray, 2- -5 = Orange, 2- -6 = Blue, 2- -7 = Red, 2- -8 = Yellow, 2- -9 = Green, 3--0 = Violet, 3--1 = Electrical Ivory

*Note: Shielded jacks are not available in colors and do not accept strain reliefs.

Product Facts

- Thin profile improves outlet density
- Modular Jacks available with integral dust covers
- 180° or 90° cable dress for easy termination
- Universal wiring label permits wiring to T568A or T568B
- Meets or exceeds all TIA and ISO component performance requirements
- Bend-limiting strain relief included with unshielded jacks
- UL Listed: E81956
- 8-Position RJ45 Modular Jacks for 1-, 2-, 3- and 4-Pair applications
- Can be terminated with either SL Series Modular Jack Termination Tool (1725150-1) or standard 110 punch-down tools (see Chapter 1.7)
- RoHS compliant

SL Series Category 3 Modular Jacks

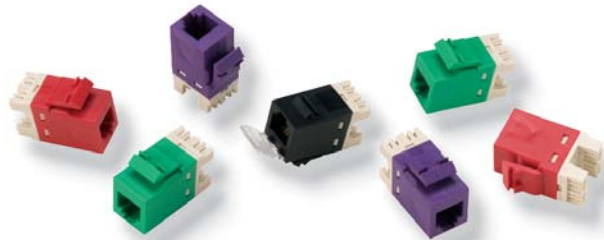

Description	Wiring Pattern	Part Number
Cat 3 Unshielded	RJ11c/RJ14c/RJ25c	Bulk Packaged - 25 Jacks
		With Dust Cover

X denotes color: -1 = Almond, -2 = Black, -3 = White, -4 = Gray, -5 = Orange, -6 = Blue, -7 = Red, -8 = Yellow, -9 = Green, 1--0 = Violet, 1--1 = Electrical Ivory

Y denotes color and bulk package: 2- -1 = Almond, 2- -2 = Black, 2- -3 = White, 2- -4 = Gray, 2- -5 = Orange, 2- -6 = Blue, 2- -7 = Red, 2- -8 = Yellow, 2- -9 = Green, 3--0 = Violet, 3--1 = Electrical Ivory

Product Facts

- Thin profile improves outlet density
- Modular Jacks available with integral dust covers
- 180° or 90° cable dress for easy termination
- UL Listed: E81956
- 6-Position RJ11c/RJ14c/RJ25c Modular Jacks for 1-, 2- and 3-Pair applications
- Can be terminated with either SL Series Modular Jack Termination Tool (1725150-1) or standard 110 punch-down tools (see Chapter 1.7)
- RoHS compliant

SL Series Modular Jack Strain Reliefs

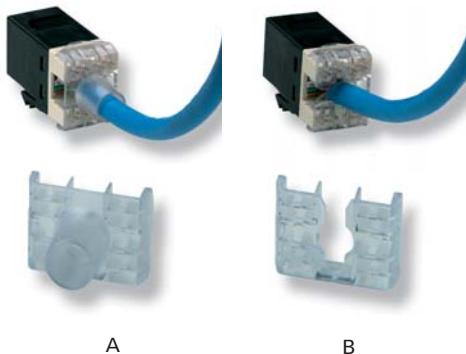

Product Facts

- Provide strain relief for terminated cables in the Work Area
- For use with unshielded SL Series Modular Jacks only

Description	Used with	Color	Figure	Part Number
Bend-Limiting Strain Relief	Category 6	Smoked Gray	A	1375200-1
	Category 5E	Blue	A	1375200-2
Strain Relief	Category 6, 5E, 3	Clear	B	1375157-1

14

SL Series Toolless Category 5e Modular Jacks



Description	Wiring Pattern	Part Number
Cat 5e Unshielded	T568A/T568B	1116604-X
	With Dust Cover	1339189-X
Cat 5e Shielded	T568A/T568B 180° (Rear) Entry	1339015-1*

X denotes color: -1 = Almond, -2 = Black, -3 = White, -4 = Gray, -5 = Orange, -6 = Blue, -7 = Red, -8 = Yellow, -9 = Green, 1--0 = Violet, 1--1 = Electrical Ivory

*Note: Shielded jacks are not available in colors.

Product Facts

- Thin profile improves outlet density
- Terminate with common pliers
- Hinged stuffer cap simplifies assembly
- Jacks available with integral dust covers
- Universal wiring label permits wiring to T568A or T568B
- Meets or exceeds all TIA and ISO component performance requirements
- UL Listed: E81956
- 8-Position RJ45 Modular Jacks for 1-, 2-, 3- and 4-Pair applications
- RoHS compliant

SL Series Toolless Category 3 Modular Jacks



Description	Wiring Pattern	Part Number
Cat 3 Unshielded	RJ11c/RJ14c/RJ25c	1116603-X
	With Dust Cover	1339188-X

X denotes color: -1 = Almond, -2 = Black, -3 = White, -4 = Gray, -5 = Orange, -6 = Blue, -7 = Red, -8 = Yellow, -9 = Green, 1--0 = Violet, 1--1 = Electrical Ivory

Product Facts

- Thin profile improves outlet density
- Terminate with common pliers
- Jacks available with integral dust covers
- UL Listed: E81956
- 6-Position RJ11c/RJ14c/RJ25c Modular Jacks for 1-, 2- and 3-Pair applications
- RoHS compliant

110Connect Modular Jacks and Accessories

1.2

110Connect Category 5e Modular Jacks



Description	Wiring Pattern	Part Number
Category 5E, Unshielded	T568A/T568B	406372-X
	Bulk Packaged - 25 Jacks	Y-406372-Y
Category 5E, Shielded	T568A/T568B	1116515-1*

X denotes color: -1 = Almond, -2 = Black, -3 = White, -4 = Gray, -5 = Orange, -6 = Blue, -7 = Red, -8 = Yellow, -9 = Green, 1--0 = Violet, 1--1 = Electrical Ivory

Y denotes color and bulk package: 2--1 = Almond, 2--2 = Black, 2--3 = White, 2--4 = Gray, 2--5 = Orange, 2--6 = Blue, 2--7 = Red, 2--8 = Yellow, 2--9 = Green, 3--0 = Violet, 3--1 = Electrical Ivory

*Note: Shielded jacks are not available in colors.

Product Facts

- Category 5E Modular Jacks meet or exceed TIA and ISO requirements
- Universal wiring label permits termination to either T568A or T568B
- UL Listed: E81956
- Can be terminated with standard 110 punch-down tools (see Chapter 1.7)
- RoHS compliant

110Connect Category 3 Modular Jacks

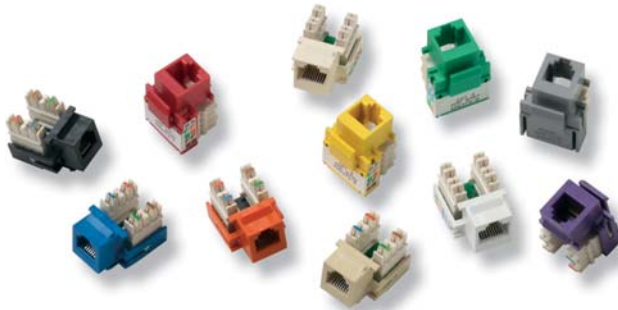

Description	Wiring Pattern	Part Number
Category 3, 8-Position	T568A/T568B	406373-X
Category 3, 6-Position	RJ11C/RJ14C/RJ25C	406375-X

X denotes color: -1 = Almond, -2 = Black, -3 = White, -4 = Gray, -5 = Orange, -6 = Blue, -7 = Red, -8 = Yellow, -9 = Green, 1--0 = Violet, 1--1 = Electrical Ivory

Product Facts

- Category 3 Jacks meet or exceed TIA and ISO requirements
- Universal wiring label for 8-position jacks permits termination to either T568A or T568B
- UL Listed: E81956
- Can be terminated with standard 110 punch-down tools (see Chapter 1.7)
- RoHS compliant

110Connect Stuffer Caps

PART NUMBER 569332-1

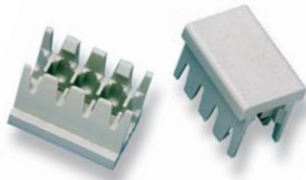

Note: 50 per bag.

Product Facts

- Available as an alternative termination method
- Provide additional strain relief
- Each stuffer cap accommodates 2 pairs
- For 110Connect Modular Jacks only

16

Keystone Category 5e Modular Couplers

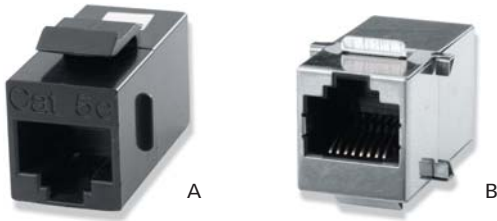

Description		Figure	Part Number
Category 5e	Unshielded	A	1479289-2
	Shielded	B	1479290-1

Product Facts

- Compact couplers for two modular plugs
- Couplers snap into 0.585" x 0.765" rectangular faceplate cutouts
- Wired one-to-one

Keystone Category 3 Modular Couplers

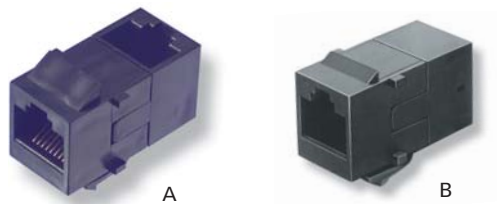

Description	Number of Positions	Figure	Part Number
Right-Angle Coupler	6	-	555049-1
	8	A	555051-1
	8 (Keyed)	-	555377-1
In-Line Coupler	6	-	555050-1
	8	B	555052-1
	8 (Keyed)	-	555376-1
	6 (MMJ/MMJ)	-	556625-1
	6 (MMJ/STD)	-	556627-1

Product Facts

- Compact couplers for two modular plugs
- Couplers snap into 0.585" x 0.765" rectangular faceplate cutouts
- Wired one-to-one

SL Series Multimedia Jacks and SVGA Assembly

1.2

SL Series Multimedia Jacks

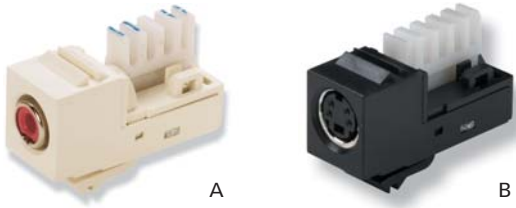

Description	Figure		Part Number
RCA	A	Red Dielectric	1479230-X
		White Dielectric	1479231-X
		Yellow Dielectric	1479232-X
S-Video	B		1375149-X

X denotes color: -1 = Almond, -2 = Black, -3 = White, -4 = Gray, 1--1 = Electrical Ivory

Product Facts

- For use where distances are less than 130 ft.
- Uses Standard 110 Termination and will accept 26-22 AWG conductors
- RCA Multimedia Jack
 - For audio and video signals
 - Uses one pair of twisted-pair cable
 - White, red or yellow dielectrics to match home theater equipment
- Not recommended for component DVD connections
- S-Video Multimedia Jack
 - For S-Video Y/C (Luminance/Chrominance Black and White/Color) signals
 - Uses two pairs of a standard twisted-pair cable

SVGA -110 Assembly
PART NUMBER 1479287-2

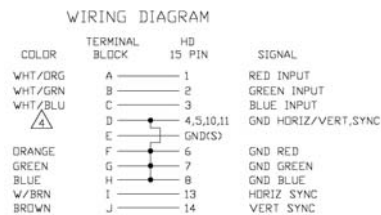

Product Facts

- Works with VGA and SVGA signals
- Features 110-Style termination for easy installation
- Is suitable for use with standard Category 5e or 6 UTP or F/UTP (recommended) cables
- Can be used where distances between monitor and computer do not exceed:
 - 15 ft. with Cat 5e UTP cable
 - 20 ft. with Cat 6 UTP cable
 - 35 ft. with Cat 5e or 6 FTP cables
- Requires a 9th conductor and is recommended for use with FTP cables (utilizes drain wire for 9th conductor)
- Dimensions: 1.180" D x 1.480" W x 0.875" H
- Stuffer caps and hex head stand-off screws included
- Assembly fits into SVGA blank SL Module, P/N 1479079 (see Chapter 3)

SVGA -Screw Terminal
PART NUMBER 1933424-2



Product Facts

- Works with VGA and SVGA signals
- Allows field termination of SVGA cable
- For distances of up to 150 feet at a resolution of 800 x 600 using standard 5 conductor 26 AWG coaxial video cable
- Terminal fits into SVGA blank SL module, P/N 1479079 (see Chapter 3)

18

Twisted Pair SL Series Multimedia Inserts

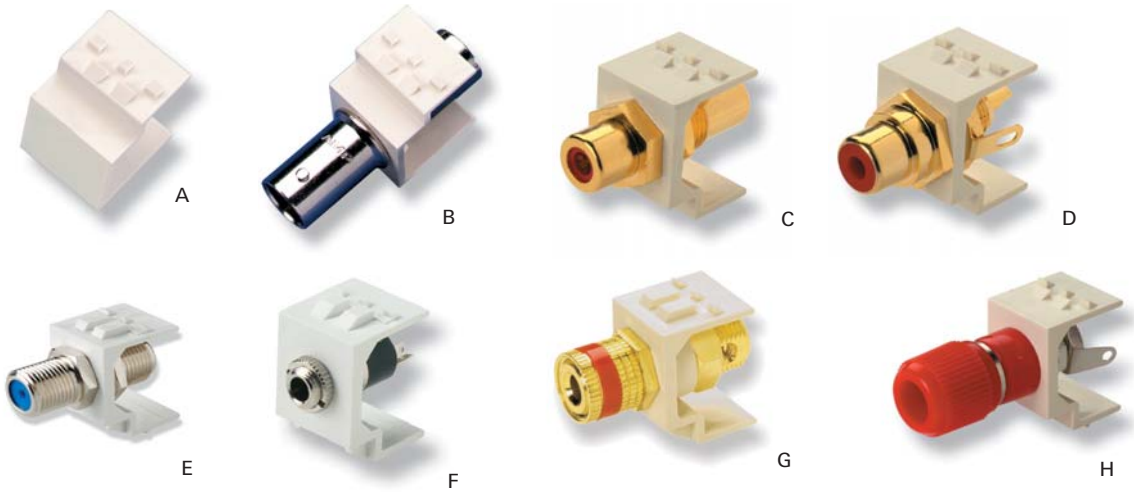

Description	Figure	Part Number
Blank	A	1116412-X
BNC Coupler	B	1339124-X
RCA Coupler	Red Dielectric	C 1375361-X
	White Dielectric	- 1375362-X
	Yellow Dielectric	- 1375363-X
	Green Dielectric	- 1933192-X
	Blue Dielectric	- 1933193-X
	Orange Dielectric	- 1933194-X
RCA, Solder Termination	Red Dielectric	D 1375364-X
	White Dielectric	- 1375365-X
	Yellow Dielectric	- 1375366-X
F-Connector Coupler, 2 GHz	E	1499855-X
3.5 mm Stereo, Mini-Headphone, Solder Termination	F	1479086-X
3.5 mm Stereo, Mini-Headphone, Screw Terminal	-	1933582-X
Speaker Post	Black Stripe	- 1479190-X
	Red Stripe	G 1479191-X
Binding Post	Black	- 1375359-X
	Red	H 1375360-X
RCA to F-Connector	I	1933096-X

X denotes insert color: -1 = Almond, -2 = Black, -3 = White, -4 = Gray, 1--1 = Electrical Ivory



Product Facts

- See Chapter 2.2 for Fiber SL Series inserts
- Provide connections for different media types
- Configure faceplates to handle various services
- May be used in straight or angled face plates, SL Series Faceplate Modules, and Mounting Straps

1.2

Category 6, 8-Position Modular Plug

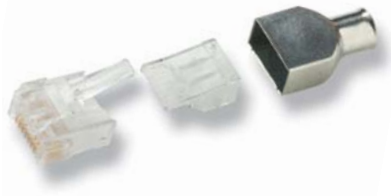

Product Facts

- Each kit includes:
 - 1 - Modular plug assembly
 - 1 - Wire holder
 - 1 - Strain relief
- RoHS compliant
- Molded with UL94V-0 Plastic
- UL Listed: E81956
- Category 6 modular plug tooling in Chapter 1.7
- Modular Plug to Die Set cross reference on page 12

Description	Conductor	AWG	Insulation O.D. in (mm)	Cable Jacket O.D. in (mm)	Part Number
Unshielded/Shielded	Solid	24 - 23	0.035 (0.89) - 0.043 (1.09)	0.20 (5.0) - 0.24 (6.0)	5-1375204-X
			0.035 (0.89) - 0.043 (1.09)	0.24 (6.0) - 0.28 (7.0)	5-1479185-X
	Stranded	26 - 24	0.035 (0.89) - 0.043 (1.09)	0.20 (5.0) - 0.24 (6.0)	5-1375202-X
			0.035 (0.89) - 0.043 (1.09)	0.24 (6.0) - 0.28 (7.0)	5-1479184-X

X denotes quantity per box: -2 = 500, -3 = 100, -4 = 25

Modular Plug Boots for Category 6 Plugs



Product Facts

- For use with Category 6, 8-Position Modular plugs
- Accept cables with diameters as listed

For Cable O.D.	Part Number									
	White	Gray	Red	Blue	Green	Yellow	Black	Orange	Violet	Brown
5 - 6 mm .20 - .24 in.	1-737893-1	1-737893-2	1-737893-3	1-737893-4	1-737893-5	1-737893-6	1-737893-7	1-737893-8	1-737893-9	2-737893-0
6 - 7 mm .24 - .28 in.	1711510-1	1711510-2	1711510-3	1711510-4	1711510-5	1711510-6	1711510-7	1711510-8	1711510-9	1-1711510-0

Category 5e Modular Plugs



Product Facts

- Meets TIA and ISO requirements for component performance
- Modular plug tooling in Chapter 1.7
- Modular plug boots (page 22)
- Each kit includes:
 - Plug housing
 - Load bar
- Load bar helps maintain pair twist
- RoHS compliant
- Molded with UL94V-0 Plastic
- UL Listed: E8 1956
- Modular Plug to Die Set cross reference on page 12

1.2

Description	AWG	Insulation O.D. in (mm)	Cable Jacket O.D. in (mm)	Conductor	Part Number
Unshielded	24	<= 0.039 (0.99)	0.190 (4.83) – 0.220 (5.59)	Stranded	5-558530-X
	28 – 24	0.035 (0.89) – 0.039 (0.99)	0.190 (4.83) – 0.200 (5.08)	Solid	5-569278-X
Shielded	26 – 24	0.035 (0.89) – 0.039 (0.99)	0.190 (4.83) – 0.200 (5.08)	Stranded	5-569552-X
				Solid	5-569550-X

X denotes quantity per box: -2 = 500, -3 = 100, -4 = 25

Category 3 Modular Plugs

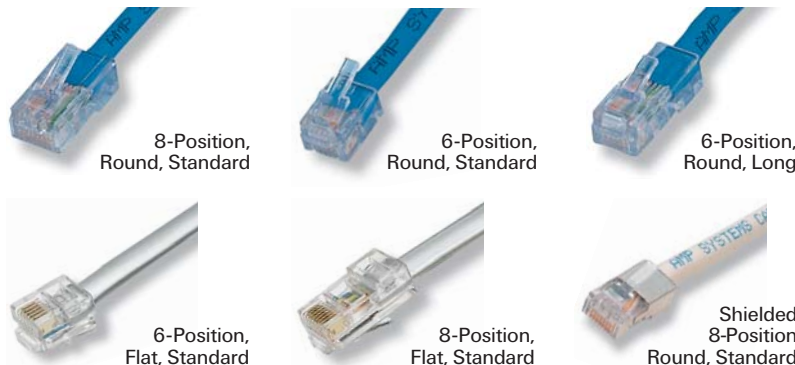

Product Facts

- Accommodate conductors as listed
- Modular plug tooling in Chapter 1.7
- RoHS compliant
- Molded with UL94V-0 rated plastic
- UL Listed: E8 1956
- Modular Plug to Die Set cross reference on page 12

Unshielded

	Pos.	Keying	Body Type	Cable Type	AWG	Insulation O.D.in (mm)	Cable Jacket O.D.in (mm)	Qty. Per Box	Part Number
Stranded	6	Unkeyed	Standard	Round	28-26	0.035 (0.89) max.	0.180 (4.58) max.	100*	5-554710-3
			Long	Round	28-26	0.029 (0.74) - 0.039 (0.99)	0.180 (4.58) max.	100*	5-555177-3
			Standard	Flat Oval	28-26	0.029 (0.74) - 0.039 (0.99)	0.090 (2.29) x 0.260 (6.61) max.	100*	5-641337-3
	8	Unkeyed	Standard	Round	28-26	0.029 (0.74) - 0.039 (0.99)	0.210 (5.33) max.	100*	5-554170-3
			Standard	Round	28-26	0.029 (0.74) - 0.039 (0.99)	0.210 (5.33) max.	100*	5-554169-3
			Long	Flat Oval	28-26	0.035 (0.89) - 0.039 (0.99)	0.100 (2.54) x 0.350 (8.89) max.	100*	5-554739-3
Solid	6	Unkeyed	Standard	Flat Oval	26-24	0.035 (0.89) - 0.039 (0.99)	0.090 (2.29) x 0.260 (6.61) max.	100*	5-555042-3
			Long	Round	26-24	0.039 (0.99) max.	0.195 (4.96) max.	100*	5-555426-3
	8	Unkeyed	Standard	Flat Oval	26-24	0.035 (0.89) - 0.039 (0.99)	0.100 (2.54) x 0.350 (8.89) max.	100*	5-554720-3
			Long	Round	26-24	0.029 (0.74) - 0.039 (0.99)	0.200 (5.08)	100*	5-557315-3
			Standard	Flat Oval	26-24	0.039 (0.99) max.	0.090 (2.29) x 0.345 (8.76) max.	500	5-555417-2
			Keyed	Standard	Flat Oval	26-24	0.039 (0.99) max.	0.090 (2.29) x 0.345 (8.76) max.	500

Shielded

Stranded	6	Unkeyed	Long	Flat Oval	28-26	0.029 (0.74) - 0.039 (0.99)	0.110 (2.79) x 0.270 (6.85) max.	1000	5-555174-2
				Round	28-26	0.029 (0.74) - 0.039 (0.99)	0.180 (4.58) max.	100*	5-555175-3
			Standard	Flat Oval	28-24	0.029 (0.74) - 0.039 (0.99)	0.110 (2.79) x 0.355 (9.02) max.	100	5-569542-3
	8		Standard	Round	28-24	0.029 (0.74) - 0.039 (0.99)	0.200 (5.08)	100	5-569532-3
Solid	8	Unkeyed	Standard	Round	26-24	0.029 (0.74) - 0.039 (0.99)	0.200 (5.08)	100	5-569530-3

*Note: 10 Boxes per Carton.

21

1.2

Modular Plug Boots

PART NUMBER 569875-X



X denotes color	
-1	Black
-2	Almond
-3	Red
-4	Green
-5	Blue
-6	Yellow
-7	Orange
-8	White
-9	Violet
1--0	Gray

Product Facts

- For use with Category 3, 5 and 5e 8-position modular plugs
- Accept cables with a maximum diameter of 0.210" (5.33 mm)

External Strain Reliefs For Modular Plugs



Description	Part Number
Not for use with Modular Plug Boots	558527-1
For use with Modular Plug Boots	558527-3

Product Facts

- Metal strain relief that positively engages plug housing
- PRO-CRIMPER Tool and Die Set in Chapter 1.7
- For use with 8-position Category 3, 5 and 5e Modular Plugs only
- RoHS compliant

Field Terminable 110Connect XC Patch Plugs



Description	Part Number
1-Pair	569477-1
2-Pair	569478-1
3-Pair	569479-1
4-Pair	569480-1

Product Facts

- 26-24 AWG stranded conductors
- Verified for Category 5e performance
- Available in various pair combinations
- Factory-terminated cable assemblies in Chapter 1.3

CHAMP 25-Pair Plugs and Accessories

CHAMP Category 3 Telco, 25-Pair, Unshielded Connector Kits

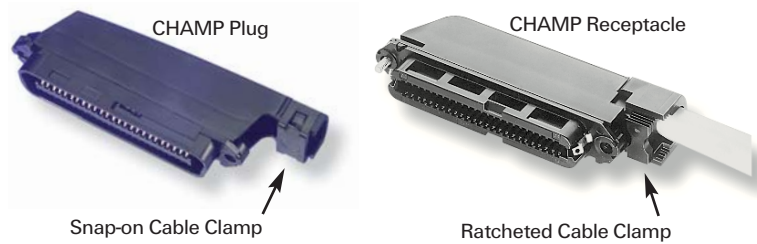

Product Facts

- Unshielded cable connectors (50-position) meet FCC requirements part 68 and RJ21 for standard telecommunications interface
- All unshielded cable-to-cable plug kits accept receptacles with integral latches

1.2

Description		Color	Part Number
CHAMP Plug	Screwlock hardware, snap-on cable clamp	Black	2299 12-1
	CHAMP-LOK hardware, ratcheted cable clamp	Gray	2299 12-4
CHAMP Receptacle	CHAMP-LOK hardware, ratcheted cable clamp	Black	5539 13-1
	Screwlock hardware, snap-on cable clamp	Black	2299 13-1
	Screwlock hardware, snap-on cable clamp	Gray	2299 13-4
	Integral latches, ratcheted adjustable cable clamp	Gray	554547-2
	Integral latches, snap-on cable clamp	Gray	554905-1
	CHAMP-LOK hardware, ratcheted cable clamp	Gray	5539 12-1

CHAMP Category 3 Telco Adapters



Product Facts

- Wear adapter (connector saver) – 50-position, plug-to-receptacle
- Plug-to-plug assembly – for mating cable ends with receptacle connectors installed
- Receptacle-to-receptacle assembly – for mating cable ends with plug connectors installed

Description	Hardware	Part Number
Plug to Receptacle Wear Adapter	–	552705-1
Plug to Plug Adapter	with J Hook Hardware	554876-1
	–	554876-2
Receptacle to Receptacle Adapter	with J Hook Hardware	554875-1
	–	554875-2

23

Baluns and Impedance Matching Adapters

1.2

IBM AS/400 Baluns



Product Facts

- Adapt AS/400 and System/3X terminals, emulator cards, controllers and printers to UTP cable
- Choose baluns to match hub type (active or passive)

RJ45 to Twin-Ax Plug

Description	Active Pin Numbers	Part Number	
		Active Star Hubs	Passive Star Hubs
RJ45 Jack to Twin-Ax Plug	4 & 5	555249-1	557857-1

10/100BASE-Tx Impedance Matching Adapters



Product Facts

- Used to adapt 100 Ohm 10BASE-T or 100BASE-Tx equipment to 150 Ohm shielded cable
- Available with unshielded or shielded modular jacks
- 8-Position jacks (pins 1, 2, 3 & 6 active)

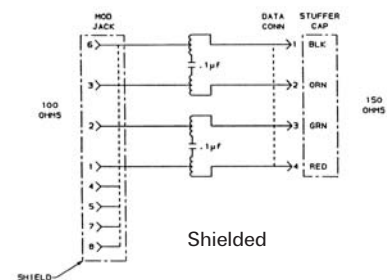
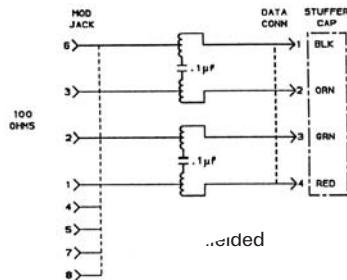

Description	Part Number	
10/100BASE-Tx Impedance Matching Adapters	Unshielded	558420-1
	Shielded	558421-1

IBM 3270 Baluns

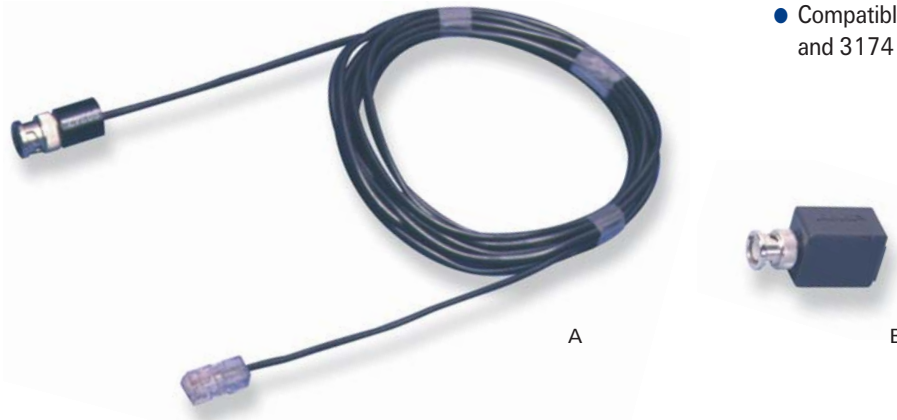

Product Facts

- Compatible with IBM 3270 and 3174 Category A devices

1.2

RJ45 to BNC Plug

Description	Figure	Active Pin Numbers	Part Number
RJ45 Plug (8-pos.) to BNC Plug with 14ft Twisted Pair Cable	A	4 & 5	555242-1
RJ45 Jack to BNC Plug	B	4 & 5 1 & 2	555330-1 555330-2

RJ11 to BNC Plug

Description	Figure	Active Pin Numbers	Part Number
RJ11 Jack to BNC Plug	B	3 & 4	555329-1

4-Position Data Connector to Modular Jack Adapters



ATM/TP-PMD

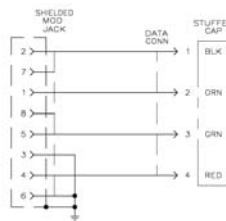

Token Ring Wiring

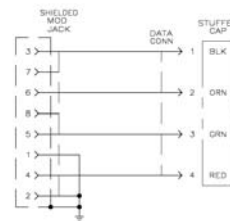

Interface Type	Wiring	Part Number
8-Position Modular Jack	ATM/TP-PMD	555414-1
	Token Ring	555414-2

25

1.2

26

TWISTED PAIR CABLE ASSEMBLIES

Patch Cable Assemblies	28-30
Category 6A	28
Category 6	28
Category 5e	29
Category 5	29
610XC	30
110Connect XC	30
MRJ21 Cable Assemblies	31
Transition Cable Assemblies	31

Chapter Summary

- A complete line of cable assemblies for any communications scenario
- Factory-terminated and tested
- Manufactured using quality AMP NETCONNECT cables and connectors
- Available in Category 6A, 6, 5e, and 5 performance in a multitude of lengths and colors
- Please call customer service at 1-800-553-0938 for quotes on custom assemblies

1.3



1.3

XG Category 6A F/UTP Patch Cable Assemblies



Product Facts

- Meets Category 6A performance standards
- Exceeds all requirements for IEEE 802.3an 10 Gigabit Ethernet
- Non-plenum (CMR rated)
- 4-Pair, stranded, F/UTP 26 AWG conductors
- Color-matched snagless boots
- Universal wiring (T568A/T568B)
- Lead-Free (no heavy metals)

Description		Part Number								
		Black	Gray	Blue	Green	Red	White	Yellow	Orange	Violet
XG Category 6A	Shielded	1499828-X	1499825-X	1499826-X	1499830-X	1499829-X	1499480-X	1499827-X	1499831-X	1499832-X

X denotes length in feet: -2 = 2, -3 = 3, -4 = 4, -5 = 5, -6 = 6, -7 = 7, -8 = 8, -9 = 9, 1-0 = 10, 1--2 = 12, 1--4 = 14, 1--5 = 15, 1--6 = 16, 2--0 = 20, 2--5 = 25, 3--0 = 30, 4--0 = 40, 5--0 = 50

Category 6 Patch Cable Assemblies

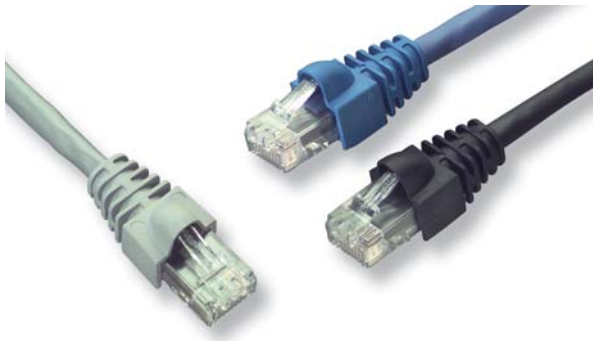

Product Facts

- Meet or exceed Category 6 performance standards
- 4-Pair stranded Unshielded 24 AWG conductors
- Non-plenum (CM rated)
- Color-matched snagless boots
- Universal wiring (T568A/T568B)
- For RJ45 SECURE assemblies, see Chapter 4
- Lead-Free (no heavy metals)

Description		Part Number								
		Black	Gray	Blue	Green	Red	White	Yellow	Orange	Violet
Category 6	Unshielded	219884-X	219885-X	219886-X	219887-X	219888-X	219889-X	219890-X	219891-X	1499023-X

X denotes length in feet: -2 = 2, -3 = 3, -4 = 4, -5 = 5, -6 = 6, -7 = 7, -8 = 8, -9 = 9, 1-0 = 10, 1--2 = 12, 1--4 = 14, 1--5 = 15, 1--6 = 16, 2--0 = 20, 2--5 = 25, 3--0 = 30, 4--0 = 40, 5--0 = 50

Category 5e Patch Cable Assemblies



Product Facts

- Meets or exceeds Category 5e performance standards
- 4-Pair stranded unshielded, 24 AWG conductors
- Non-Plenum (CM rated)
- Booted cable assemblies include color-matched snagless boots
- Universal wiring (T568A/T568B)
- Lead-Free (no heavy metals)

1.3

Description	Figure	Part Number								
		Black	Gray	Blue	Green	Red	White	Yellow	Orange	Violet
Booted	A	406483-X	219241-X	219242-X	219243-X	219244-X	219245-X	219246-X	219184-X	1499094-X
Bootless	B	1499110-X	1499111-X	1499112-X	1499113-X	1499114-X	1499115-X	1499116-X	1499117-X	1499118-X
Booted, Shielded	-	-	1499479-X	-	-	-	-	-	-	-

X denotes length in feet: -2 = 2, -3 = 3, -4 = 4, -5 = 5, -6 = 6, -7 = 7, -8 = 8, -9 = 9, 1-0 = 10, 1-2 = 12, 1-4 = 14, 1-5 = 15, 1-6 = 16, 2-0 = 20, 2-5 = 25, 3-0 = 30, 4-0 = 40, 5-0 = 50

Category 5 F/UTP Patch Cable Assembly Part Number 557827-X



Product Facts

- Meets or exceeds Category 5 performance standards
- Shielded cable assemblies feature 4-Pair stranded, 26 AWG conductors
- Non-Plenum (CM rated)
- Cable/Snagless Boot Color: Black
- Universal wiring (T568A/T568B)
- Lead-Free (no heavy metals)

X denotes length in feet: -1 = 2, -2 = 4, -3 = 6, -4 = 8, -5 = 12, -6 = 16, -7 = 20, -8 = 10, -9 = 75, 1-0 = 50

Ethernet Crossover Cable Assemblies

Performance		Cable/Boot Color	Part Number
Category 6	Standard	Red/Black	1499150-X
Category 5e	Standard	White/Black	1499151-Y
Category 5	Standard	Orange/Black	219153-Z

X denotes length in feet: -3 = 3, -5 = 5, -7 = 7, 1-0 = 10, 1-2 = 12, 1-5 = 15, 2-5 = 25
 Y denotes length in feet: -3 = 3, -5 = 5, 1-0 = 10, 1-2 = 12, 1-5 = 15
 Z denotes length in feet: -1 = 3, -2 = 12, -3 = 5, -4 = 10, -5 = 25

Product Facts

- Category 5e and Category 5 crossover cables are compatible with IEEE 802.3 10/100BASE-T
- Category 6 crossover cables are compatible with 10/100BASE-T, as well as IEEE 802.3 1000BASE-T
- For other lengths and wiring diagrams, see Customer Drawing
- Lead-Free (no heavy metals)

29

1.3

610XC Category 6 Cable Assemblies

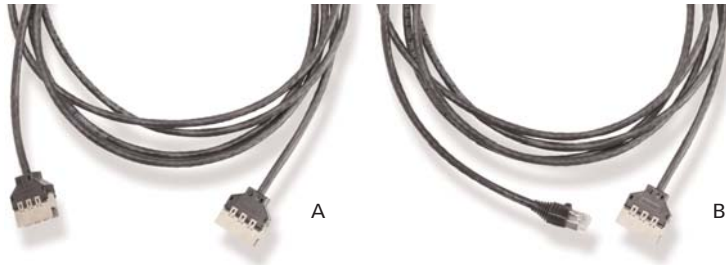

Product Facts

- Meets or exceeds Category 6 performance requirements
- Stranded unshielded, 24 AWG conductors, pair counts as listed
- Non-Plenum (CM rated)
- Lead-Free (no heavy metals)

Description	Figure	Part Number
610XC to 610XC	1-Pair	1479265-X
	2-Pair	1479266-X
	4-Pair	1479267-X
610XC to RJ45	4-Pair, T568A	1499414-X
	4-Pair, T568B	1499413-X

X denotes length in feet: -2 = 2, -4 = 4, -6 = 6, -8 = 8, 1-0 = 10

110Connect XC Category 5e Cable Assemblies



Product Facts

- Meets or exceeds Category 5e performance requirements
- 4-Pair stranded unshielded, 24 AWG conductors
- Modular RJ45 plugs feature color-matched snagless boots
- 110Connect XC to RJ45 Patch Cable Assemblies must be selected to match wiring pattern of work area outlet wiring
- Non-Plenum (CM rated)
- Universal wiring (T568A/T568B)
- Lead-Free (no heavy metals)

Description	Pair Count	Wiring	Figure	Part Number
110Connect XC to 110Connect XC	1-Pair	-	-	569523-X
	2-Pair	-	-	569524-X
	3-Pair	-	-	569525-X
	4-Pair	-	A	569526-X
	4-Pair	T568A	B	569527-X
	4-Pair	T568B	B	569528-X
110Connect XC to RJ45	2-Pair	T568A, 10/100BASE-T	-	569685-X
	2-Pair	T568B, 10/100BASE-T	-	569669-X
	2-Pair	T568A, Token Ring	-	569686-X
	2-Pair	T568B, Token Ring	-	569672-X
	2-Pair	T568A, ATM/PMD	-	569687-X
	2-Pair	T568B, ATM/PMD	-	569673-X

X denotes length in feet: -2 = 2, -4 = 4, -6 = 6, -8 = 8, 1-0 = 10

MRJ21 & Transition Cable Assemblies

MRJ21 Cable Assemblies

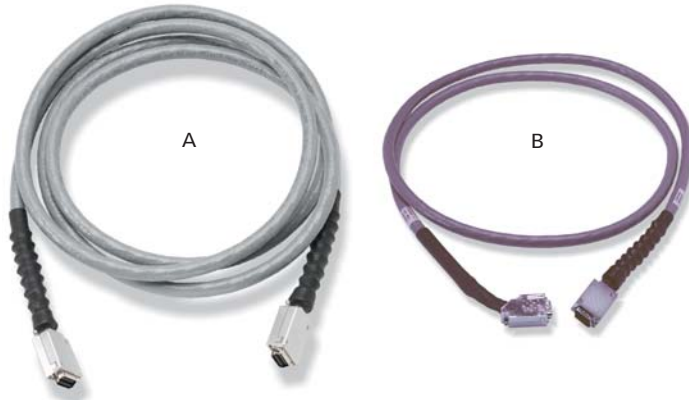

Product Facts

- Dense CHAMP style double blade design with offset jackscrews
- Contact layout and footprint for differential pairs creates reduced cross-talk and built in compensation
- 1.5 to 4 times the port density of 2x6 Stacked Modular Jack (RJ45)
- 3 times the port density of RJ21
- Jackscrews for positive latching and secure cable retention
- Common and custom cable assembly lengths are available - contact your local sales engineer for more information
- 25-Pair, unshielded, 24 AWG conductors
- CMR cable jacketing is gray
- CMP cable jacketing is blue
- Lead-Free (no heavy metals)

1.3

Connector A	Connector B	Rating	Figure	Part Number
MRJ21 (180° Back Shell)	MRJ21 (180° Back Shell)	CMR (Riser)	A	1499515-X
		CMP (Plenum)	A	1499518-X
	MRJ21 (45° Back Shell)	CMR (Riser)	B	1499517-X
		CMP (Plenum)	B	1933061-X
	RJ21 (45° Back Shell)	CMR (Riser)	-	1499516-X
MRJ21 (45° Back Shell)	RJ21 (180° Back Shell)	CMP (Plenum)	-	1499519-X
	6 RJ45 (GbE)	CMR (Riser)	-	1499520-X
		CMP (Plenum)	-	1933056-X
	6 RJ45 (GbE)	CMR (Riser)	-	1499508-X

X denotes length in meters: -1 = 1, -2 = 2, -3 = 3, -4 = 4, -5 = 5, -6 = 6, -7 = 7, -8 = 8, -9 = 9, 1-0 = 10, 1-2 = 12, 1-5 = 15, 1-7 = 17, 2-0 = 20, 2-5 = 25, 3-0 = 30, 3-5 = 35, 4-0 = 40, 5-0 = 50, 6-0 = 60, 7-0 = 70, 8-0 = 80, 9-0 = 90

Consolidation Point Transition Cable Assemblies



Product Facts

- Form connections between work area and consolidation point
- Factory-assembled and tested
- Save time and money on moves, adds and changes
- Lead-Free (no heavy metals)

Description	UL/NEC Rating	Wiring Pattern	Part Number
Category 6 Modular Plug to SL Series 110Connect Modular Jack	Riser (CMR)	T568A	219596-X
		T568B	219597-X
	Plenum (CMP)	T568A	219598-X
		T568B	219599-X
Category 5e Modular Plug to SL Series 110Connect Modular Jack	Riser (CMR)	T568A	219172-Y
		T568B	219173-Y
	Plenum (CMP)	T568A	219174-Y
		T568B	219175-Y

X denotes length in feet: -3 = 40, -4 = 50

Y denotes length in feet: -1 = 20, -2 = 30, -3 = 40, -4 = 50

31

1.3

32

TWISTED PAIR PATCH PANELS

Category 6A Patch Panels	34
Category 6 Patch Panels	35
Category 5e SL Series Patch Panels	36
Category 5e 110Connect Patch Panels	37
Category 5 and Category 3 Patch Panels	38-39
Multimedia Patch Panels	40
Discrete SL Series Patch Panels	41
Modular Jack Patch Panels and Accessories	42
ACO Patch Panels and Accessories	43-46
Patch Panel Accessories	47-50

Chapter Summary

- Tyco Electronics features a comprehensive line of AMP NETCONNECT 110Connect, SL Series, ACO, discrete jack and 25-pair patch panels for twisted pair applications

1.4

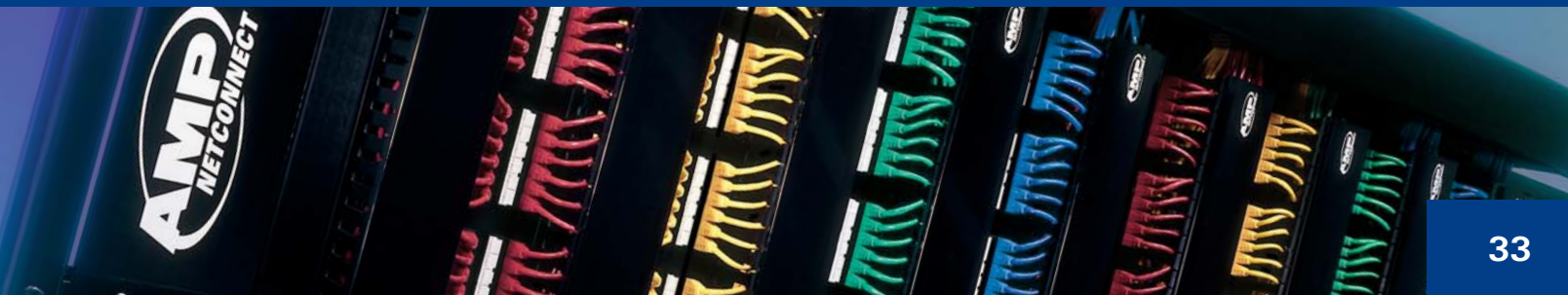

1.4

XG Category 6A AMP-TWIST Shielded Patch Panels

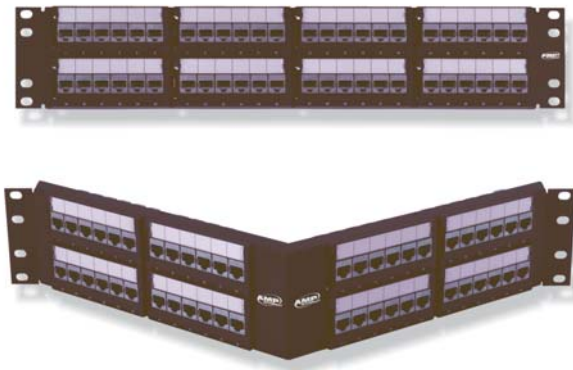

Description	Height	Width	Figure	Part Number
24-Port Straight Panel	1U (1.75")	19.0"	–	1933319-2
48-Port Straight Panel	2U (3.50")	19.0"	A	1933320-2
24-Port Angled Panel	1U (1.75")	19.0"	–	1933321-2
48-Port Angled Panel	2U (3.50")	19.0"	B	1933322-2

Product Facts

- Meets or exceeds all TIA/EIA Category 6A performance standards
- Will allow 10GBASE-T (IEEE 802.3an) on 100 meter channels
- Shielded installation made simple with jacks
- Ports may be individually replaced
- Packaged unloaded with jacks bagged separately for termination with SL Series Jack Termination Tool (Chapter 1.7)
- Available in straight and angled versions
- Labels and label covers included
- Accommodates icons (sold separately)
- Integrated bonding bar makes bonding simple and requires no extra steps

Cable Management Bracket

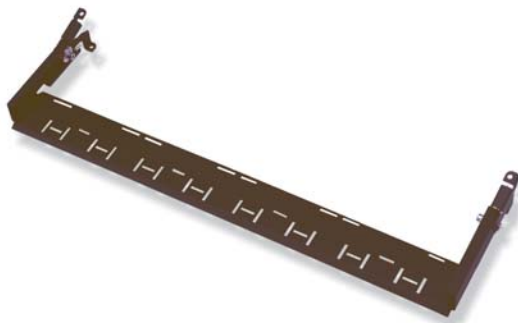

Description	Height	Width	Part Number
Cable Management Bracket	1U (1.75")	19.0"	1933425-1

Product Facts

- Mounts directly to the 1U 24 Port AMP-TWIST panels listed above
- Unique bracket for cabinet applications or other applications where a rear flange is not available for mounting a typical cable support bar
- Additional cable support bars are located in this chapter

Category 6 SL Series Patch Panels

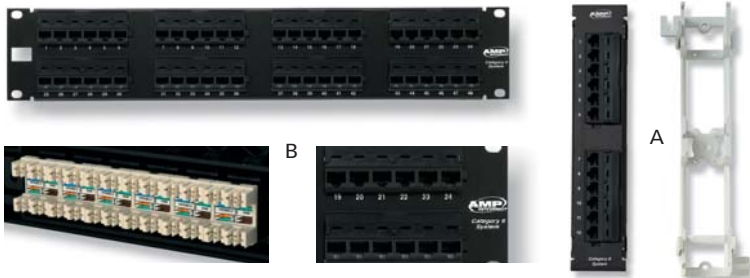

Description	Height	Width	Figure	Part Number
12-Port	10.00"	2.3"	A	1375013-2
24-Port	1U (1.75")	19.0"	–	1375014-2
48-Port	2U (3.50")	19.0"	B	1375015-2
96-Port	4U (7.00")	19.0"	–	1375016-2

Product Facts

- Meets or exceeds TIA and ISO Category 6 component performance requirements
- Ports may be individually replaced
- Packaged unloaded with jacks bagged separately for termination with SL Series Jack Termination Tool (Chapter 1.7)
- Universal wiring – may be terminated to T568A or T568B
- Replacement labels and clear label covers in Chapter 8
- 12-Port Mini Patch Panels mount vertically on 89D bracket (included)

Category 6 Angled SL Series Patch Panels



Description	Height	Width	Figure	Part Number
24-Port	1U (1.75")	19.0"	A	1499600-2
48-Port	2U (3.50")	19.0"	B	1499601-2

Product Facts

- Meets or exceeds TIA and ISO Category 6 component performance requirements
- Allow elimination of horizontal cable management for higher rack densities and ease of cable dress
- Ports may be individually replaced
- Packaged unloaded with jacks bagged separately for termination with SL Series Jack Termination Tool (Chapter 1.7)
- Universal wiring – may be terminated to T568A or T568B
- Replacement labels and clear label covers in Chapter 8

Category 5e SL Series Patch Panels

1.4

Category 5e SL Series Patch Panels

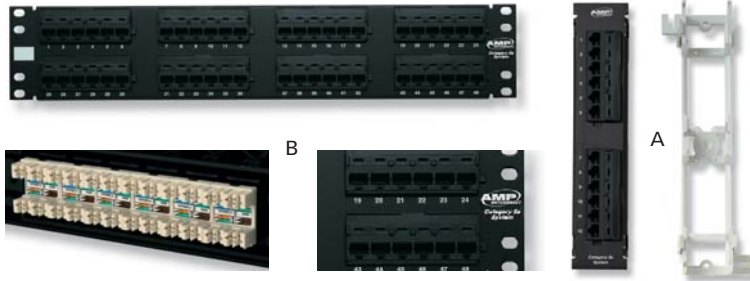

Description	Height	Width	Figure	Part Number
12-Port	10.00"	2.3"	A	1479153-2
24-Port	1U (1.75")	19.0"	–	1479154-2
48-Port	2U (3.50")	19.0"	B	1479155-2
96-Port	4U (7.00")	19.0"	–	1479156-2

Product Facts

- Meets or exceeds TIA and ISO Enhanced Category 5 (Category 5e) component performance requirements
- Ports may be individually replaced
- Packaged unloaded with jacks bagged separately for termination with SL Series Jack Termination Tool (see Chapter 1.7)
- Universal wiring – may be terminated to T568A or T568B
- Replacement labels and clear label covers in Chapter 8
- 12-Port Mini Patch Panels mount vertically on 89D bracket (included)

Category 5e Angled SL Series Patch Panels



Description	Height	Width	Figure	Part Number
24-Port	1U (1.75")	19.0"	A	1499602-2
48-Port	2U (3.50")	19.0"	B	1499603-2

Product Facts

- Meets or exceeds TIA and ISO Enhanced Category 5 (Category 5e) component performance requirements
- Allow elimination of horizontal cable management for higher rack densities and ease of cable dress
- Ports may be individually replaced
- Packaged unloaded with jacks bagged separately for termination with SL Series Jack Termination Tool (see Chapter 1.7)
- Universal wiring – may be terminated to T568A or T568B
- Replacement labels and clear label covers in Chapter 8

Category 5e 110Connect Patch Panels

Category 5e 110Connect Patch Panels

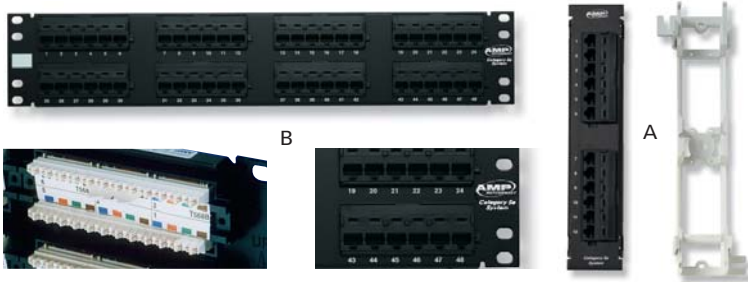

Description	Height	Width	Figure	Part Number
12-Port	10.00"	2.3"	A	406390-1
12-Port	1U (1.75")	19.0"	—	406981-1
24-Port	1U (1.75")	19.0"	—	406330-1
48-Port	2U (3.50")	19.0"	B	406331-1
96-Port	4U (7.00")	19.0"	—	406332-1

Product Facts

- Meets or exceeds TIA and ISO Enhanced Category 5 (Category 5e) component performance requirements
- May be terminated using single-wire or 5-pair tools
- Universal wiring — may be terminated to T568A or T568B
- Replacement labels and clear label covers in Chapter 8
- 12-Port Mini Patch Panels mount vertically on 89D bracket (included)

1.4

Category 5e Angled 110Connect Patch Panels



Description	Height	Width	Figure	Part Number
24-Port	1U (1.75")	19.0"	A	1499604-1
48-Port	2U (3.50")	19.0"	B	1499605-1

Product Facts

- Meets or exceeds TIA and ISO Enhanced Category 5 (Category 5e) component performance requirements
- Allow elimination of horizontal cable management for higher rack densities and ease of cable dress
- May be terminated using single-wire or 5-pair tools
- Universal wiring — may be terminated to T568A or T568B
- Replacement labels and clear label covers in Chapter 8

Category 5e Integrated Cable Management 110Connect Patch Panels



Description	Height	Width	Part Number
24-Port	1U (1.75")	19.0"	1479206-1
48-Port	2U (3.50")	19.0"	1479208-1

Product Facts

- Meets or exceeds TIA and ISO Enhanced Category 5 (Category 5e) component performance requirements
- Allow elimination of horizontal cable management for higher rack densities and ease of cable dress
- May be terminated using single-wire or 5-pair tools
- Universal wiring — may be terminated to T568A or T568B
- Replacement labels and clear label covers in Chapter 8

37

Category 5 and Category 3 Patch Panels

1.4

Category 5, 10/100BASE-T, RJ21 (25-Pair) Patch Panel and Cable Assemblies



Product Facts

- Meets or exceeds TIA and ISO Category 5 component performance requirements
- Provides RJ45 breakouts from 10/100BASE-T switches and hubs that use the 25-pair telecommunications interface
- Compatible with CISCO hubs and switches
- Use with 25-pair plug to plug cable assemblies listed
- Cable assemblies are for use with this patch panel only
- 2U (3.50") x 19" Patch Panel

Description	Part Number
Category 5, 10/100BASE-T, 25-Pair Patch Panel	1116732-1
Left-hand Exit Cable Assembly	1116733-X
Right-hand Exit Cable Assembly	1116734-X

X denotes length in feet: -5 = 5, -7 = 7, 1--0 = 10, 1--5 = 15

Category 3 Patch Panels



Product Facts

- Meets or exceeds TIA and ISO Category 3 component performance requirements
- Available in 2- through 4-pair for voice and low speed data applications
- Fit standard 19" racks

Description	Height	Wiring Pattern	Part Number
24-Port	1U (1.75")	RJ25C (3-Pair)	558257-1
		RJ14C (2-Pair)	557403-1
48-Port	2U (3.50")	RJ25C (3-Pair)	558258-1
		RJ14C (2-Pair)	557411-1
96-Port	4U (7.00")	RJ25C (3-Pair)	558259-1
		RJ14C (2-Pair)	557415-1

Category 3 25-Pair Patch Panels

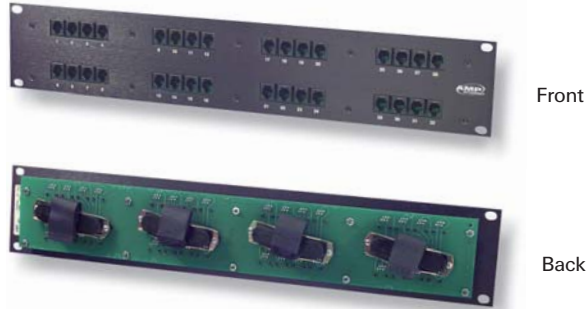

Product Facts

- Meets or exceeds TIA and ISO Category 3 component performance requirements
- Available in 2- through 4-pair for voice and low speed data applications

1.4

Description	Height	Width	Modular Jack Type	Active Pins	Wiring Diagram	Number of 25-Pair Plugs	Part Number
24-Port	1U (1.75")	19"	1-Pair (6-Pos.)	3&4	A	1	556189-1
			2-Pair (6-Pos.)	2-5	D	2	556183-1
			4-Pair (8-Pos.)	1-8	G	4	556180-1
			4-Pair (8-Pos.)	1-8	F	4	556186-1
32-Port	2U (3.50")	19"	1-Pair (8-Pos.)	4&5	C	2	555480-1
			1-Pair (6-Pos.)	3&4	A	2	555481-1
			2-Pair (6-Pos.)	2-5	D	3	555366-1
			3-Pair (6-Pos.)	1-6	E	4	555043-1
			4-Pair (8-Pos.)	1-8	F	6	555370-1
			4-Pair (8-Pos.)	1-8	C	2	555482-1
48-Port	3U (5.25")	19"	1-Pair (6-Pos.)	3&4	A	2	555483-1
			2-Pair (6-Pos.)	2-5	D	4	555375-1
			2-Pair (8-Pos.) 10BASE-T	1-3&6	H	4	556905-1
			3-Pair (6-Pos.)	1-6	E	6	555346-1
			4-Pair (8-Pos.)	1-8	F	8	555383-1
			4-Pair (8-Pos.)	1-8	G	8	556641-1

25-Pair Patch Panel Wiring Configurations

A. 1-Pair (6-Position)

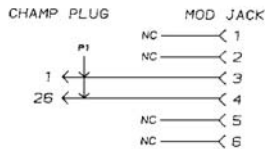

B. 1-Pair (6-Position)

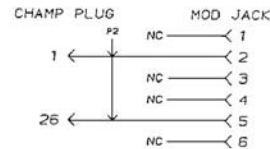

C. 1-Pair (8-Position)

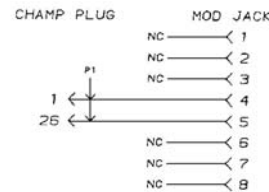

D. 2-Pair (6-Position)

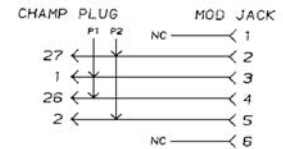

E. 3-Pair (6-Position)

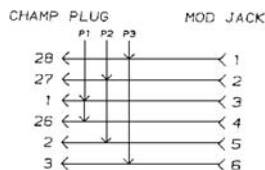

F. 4-Pair (T568B)

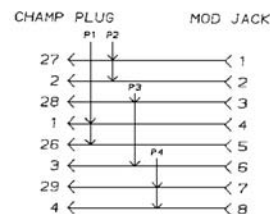

G. 4-Pair (T568A)

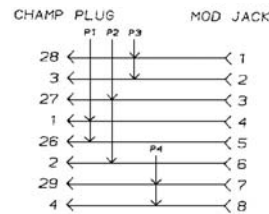

H. 2-Pair (10BASE-T Wiring)

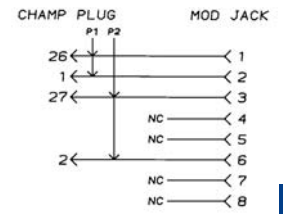

NOTE: On 32-Port 1-Pair panels CHAMP plugs are loaded pairs 1-16. All others are loaded pairs 1-24.

39

Multimedia Patch Panels

1.4

Multimedia SL Series Patch Panels

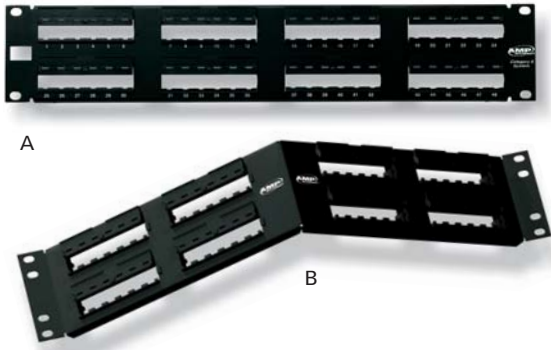

Description	Height	Width		Figure	Part Number
12-Port	10.00"	2.3"	Straight	-	*1375289-1
12-Port	1U (1.75")	19.0"	Straight	-	1933412-1
24-Port	1U (1.75")	19.0"	Straight	-	1933307-1
			Angled	-	1933309-1
48-Port	2U (3.50")	19.0"	Straight	A	1933308-1
			Angled	B	1933310-1

*Note: Does not accept AMP-TWIST or shielded SL Series jacks

Product Facts

- Accepts AMP-TWIST, shielded, and unshielded SL Series Jacks and inserts
- May be used to create custom configurations – including mixing fiber, twisted-pair, coax and A/V applications
- Ports may be individually replaced
- Angled versions allow elimination of horizontal cable management for higher rack densities and ease of cable dress
- Replacement labels and clear label covers in Chapter 8

Cable Management Bracket

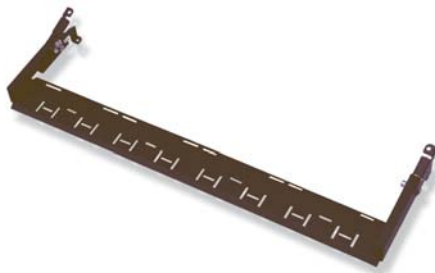

Description	Height	Width	Part Number
Cable Management Bracket	1U (1.75")	19.0"	1933425-1

Product Facts

- Mounts directly to the 1U panels listed above
- Unique bracket for cabinet applications or other applications where a rear flange is not available for mounting a typical cable support bar
- Additional cable support bars are located in this chapter

Multimedia Integrated Cable Management SL Series Patch Panels



Description	Height	Width	Part Number
24-Port	1U (1.75")	19.0"	1479449-1
48-Port	2U (3.50")	19.0"	1479450-1

Product Facts

- Accept unshielded SL Series Jacks and inserts
- May be used to create custom configurations – including mixing fiber, twisted-pair, coax and A/V applications
- Allow elimination of horizontal cable management for higher rack densities and ease of cable dress
- Ports may be individually replaced
- Replacement labels and clear label covers in Chapter 8

40

Discrete Multimedia SL Series Patch Panel

PART NUMBER 1375156-1



Product Facts

- Accepts SL Series Jacks, MT-RJ Outlet Jacks, and SL Series Inserts (purchased separately)
- May be used to create custom configurations, including mixing fiber, twisted-pair, coax and A/V applications
- Allows for easy integration of fiber with copper in the same patch panel
- Clear cover on rear allows easy accessibility
- Shelf in back of panel organizes and manages cable
- Uses 110Connect XC labels (see Chapter 8)
- 2U (3.50") x 19" W x 8" D

Discrete High Density Angled SL Series Patch Panel



Product Facts

- Accepts AMP-TWIST, shielded, and unshielded SL Series Jacks and inserts (purchased separately)
- Highest density solution for 2U (3.50")
- Ports may be individually replaced
- Angled version allow elimination of horizontal cable management for higher rack densities and ease of cable dress

Description	Height	Width	Part Number
72-Port Discrete Angled Panel	2U (3.50")	19.0"	1499613-1

Modular Jack Patch Panels and Accessories

1.4

110Connect Modular Jack Patch Panels

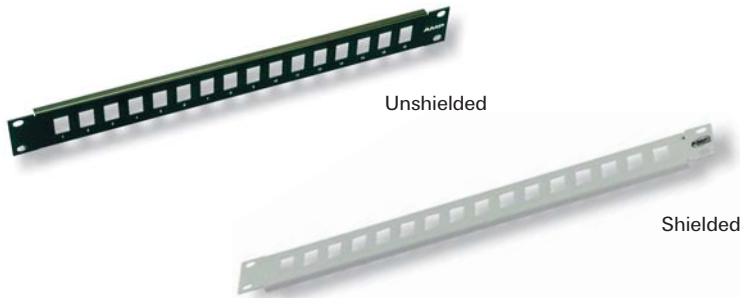

Description	Height	Width	Part Number
16-Port	1U (1.75")	19.0"	557429-X
32-Port	2U (3.50")	19.0"	557430-X
48-Port	3U (5.25")	19.0"	557431-X

X denotes shielding: -1 = Unshielded, -2 = Shielded
 NOTE: Shielded patch panels use grounding lug kit 556438-1 for isolated grounding

Product Facts

- Shielded patch panels accept shielded 110Connect and Inserts for 110Connect Modular Jack Patch Panels
- Unshielded patch panels accept unshielded 110Connect and Inserts for 110Connect Modular Jack Patch Panels
- May be used to create custom configurations
- Ports may be individually replaced

Inserts for 110Connect Modular Jack Patch Panels and Standard 0.582" x 0.762" Openings

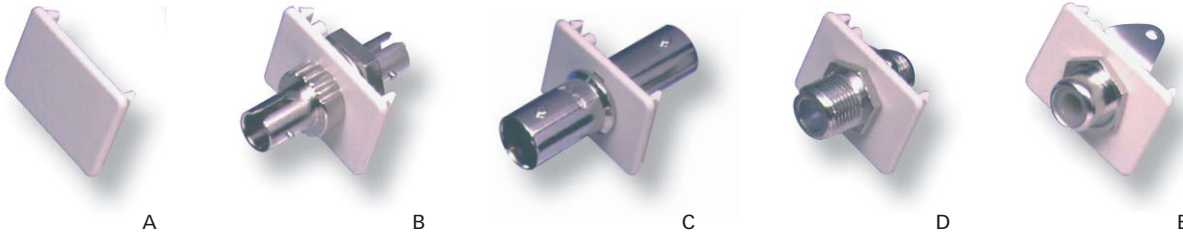

Description	Figure	Part Number
Blank	A	558856-X
Multimode ST Coupler	B	558860-X
BNC Coupler	C	558861-X
F-Connector Coupler	D	558862-X
RCA, Solder-Type	E	569983-X

X denotes color: -1 = Black, -2 = Almond
 NOTE: Not compatible with Standard or Angled Faceplates or Office Boxes.

Product Facts

- Used with 110Connect Modular Jack Patch Panels
- Multimode ST Coupler is suitable for use with Multimode Connectors

Category 6, ACO Single-Port Patch Panel Kits, Preloaded



A



B



C



D

Product Facts

- Combines the flexibility and adaptability of the ACO System with the performance and headroom of Category 6
- Meets TIA and ISO requirements for Category 6 component performance
- Category 6 ACO Installation Kits are backwardly compatible with standard ACO Inserts
- Preloaded with Category 6 ACO Single-Port Installation Kits. Category 6 ACO Inserts purchased separately (see Chapter 3)
- Fit standard 19" racks

Description		Height	Width	Figure		Part Number
16-Port	Iconable	3U (5.25")	19"	A	Shielded	1479312-1*
					Unshielded	1479311-1*
	Non-Iconable	2U (3.50")	19"	B	Shielded	1479310-1
					Unshielded	1479309-1
32-Port	Non-Iconable	4U (7.00")	19"	C	Shielded	1479314-1
					Unshielded	1479313-1
64-Port	Non-Iconable	8U (14.00")	19"	D	Shielded	1479316-1
					Unshielded	1479315-1

*Note: Iconable patch panels accept AMP NETCONNECT Icons for identification. Icons are purchased separately (see Chapter 8)

ACO Patch Panels

1.4

High Density ACO Single-Port Patch Panel Kit

PART NUMBER 1479834-1

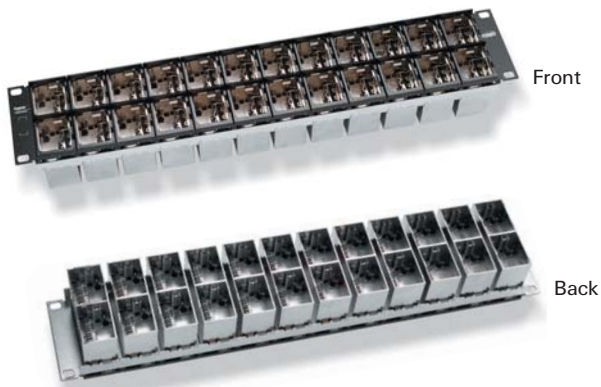

Product Facts

- ACO Inserts sold separately (see Chapter 3)
- Preloaded with shielded Category 6 single-port connector housings
- Provides a high density solution for ACO Patching - 24 Ports in 2U
- Kit includes:
 - Unlocking tool
 - Faceplates
 - Edge connectors
 - Rear covers
- Dimensions: 2U (3.50") H x 19.0" W x 2.17" D

ACO Single-Port Patch Panel Kits, Preloaded



Note: Inserts sold separately

Product Facts

- ACO Inserts sold separately (see Chapter 3)
- Preloaded with shielded or unshielded single-port connector housings
- Provide flexibility and adaptability
- Apply an adapter insert, identical to the outlet insert, to the closet of the cable
- Eliminate wiring errors and provide transparent migration between applications
- Each kit contains preloaded panel, edge connectors, ground shields, EMI/RFI clips, mounting hardware and isolation bushings
- Fit standard 19" racks

Description	Height		Part Number	
			AMP-BARREL Edge Connector	110Connect Edge Connector
16-Port	2U (3.50")	Unshielded	-	406363-1
		Shielded	-	-
	3U (5.25")	Unshielded, Iconable	406369-1	406359-1
		Shielded, Iconable	406370-1	-
32-Port	4U (7.00")	Unshielded	-	406365-1
		Shielded	-	-
64-Port	8U (14.00")	Unshielded	-	406367-1
		Shielded	-	-

NOTE: Both AMP-BARREL and 110Connect edge connectors provide Category 5e performance when combined with Category 5e inserts.

ACO Single-Port Patch Panel Kits, Unloaded

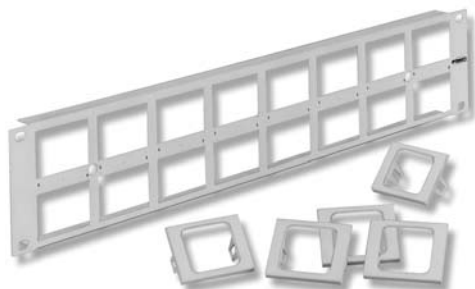

Description	Height	Width	Part Number
16-Port	2U (3.50")	19.0"	556245-1
32-Port	4U (7.00")	19.0"	556246-1
64-Port	8U (14.00")	19.0"	556247-1

Product Facts

- ACO inserts sold separately (see Chapter 3)
- Provide flexibility and adaptability
- Allow construction of unshielded or mixed (shielded/unshielded) panels
- Each kit contains a panel, faceplates, mounting hardware and isolation bushings
- Single-port installation kits purchased separately

1.4

ACO Single-Port Installation Kits

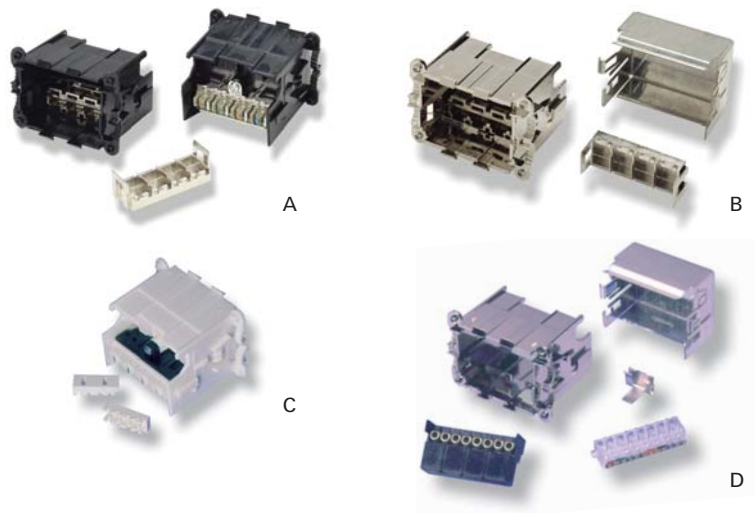

Description	Edge Connector	110-Style	Figure	Part Number
Category 6 Single-Port Installation Kit	Unshielded	110-Style	A	1479317-1*
	Shielded	110-Style	B	1479318-1*
Single-Port Installation Kit (Category 5e)	Unshielded	110-Style	C	406360-1*
		AMP-BARREL	-	406389-1
	Shielded	110-Style	-	406361-1*
		AMP-BARREL	D	406388-1

*Note: Not for use with Type 1 Cable.

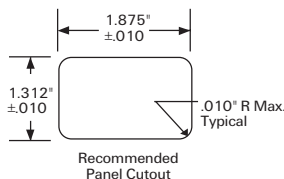

Product Facts

- ACO inserts sold separately (see Chapter 3)
- Combines the flexibility and adaptability of the ACO System with the performance and headroom of Category 6
- Meets or exceeds TIA and ISO requirements for component performance
- Category 6 ACO Installation Kits are backwardly compatible with standard ACO Inserts
- Used to mount a single ACO Insert
- Single-port kit may be snapped into .040" - .090" thick panel with a minimum of 1⁵/₈" clearance behind the panel
- Optional screw mounting capability is provided for thicker panels
- Modular furniture faceplate kit adapts the single-port module for installation in standard modular furniture raceway knockouts
- Panel mount faceplates are available for custom applications
- Unshielded kit includes unshielded insert housing, edge connector, and shield clip/strain-relief
- Shielded kit includes shielded insert housing, edge connector, rear shield and shield clip/strain-relief

45

ACO Patch Panels and Accessories

1.4

**ACO Dual-Port Patch Panel Kit, 16-Port
PART NUMBER 556090-1**



Wall brackets and grounding lug kit in this Chapter.

Product Facts

- ACO Inserts are purchased separately (see Chapter 3)
- Provides flexibility and adaptability
- Kit includes patch panel, cover plates and mounting hardware to support eight AMP Communications Outlets
- Dual-port installation kits (below) are purchased separately
- Panel height – 5.25"

ACO Dual-Port Installation Kits



Product Facts

- ACO Inserts are purchased separately (see Chapter 3)
- Used to mount ACO Inserts
- Category 6 Dual-Port Installation Kits -
 - Combines the flexibility and adaptability of the ACO System with the performance and headroom of Category 6
 - Meets or exceeds TIA and ISO requirements for Category 6 component performance requirements when combined with Category 6 Inserts
 - Category 6 ACO Installation Kits are backwardly compatible with standard ACO Inserts
 - Unshielded kits include unshielded insert housing, and two edge connectors
 - Unshielded kits are recommended for installation in 4" square x 2 1/2" deep electrical boxes with standard 100 Ohm UTP cable
- Standard Dual-Port Installation Kits
 - Both 110-Style and AMP-BARREL termination provide Category 5e performance when combined with Category 5e inserts
 - Available in both shielded and unshielded kits
 - Unshielded kits include unshielded insert housing, and two edge connectors
 - Unshielded kits are recommended for installation in 4" square x 2 1/2" deep electrical boxes with standard 100 Ohm UTP cable
 - Shielded kits include shielded insert housing, two edge connectors, ground shield and shield clip/strain-relief
 - Shielded kits are recommended for installation in 4" square x 2 1/2" deep electrical boxes with standard 100 Ohm shielded cable (110-Style Edge Connectors) or 150 Ohm Type 1 cable (AMP-BARREL Edge Connectors)

Description	Edge Connector	Figure	Part Number	
Category 6 Dual-Port Installation Kit	Unshielded	110-Style	A	1479306-1
		AMP-BARREL	C	406352-1
Standard Dual-Port Installation Kit	Unshielded	110-Style	B	406091-1
		AMP-BARREL	-	555601-1

46

Hinged Patch Panel Accessories

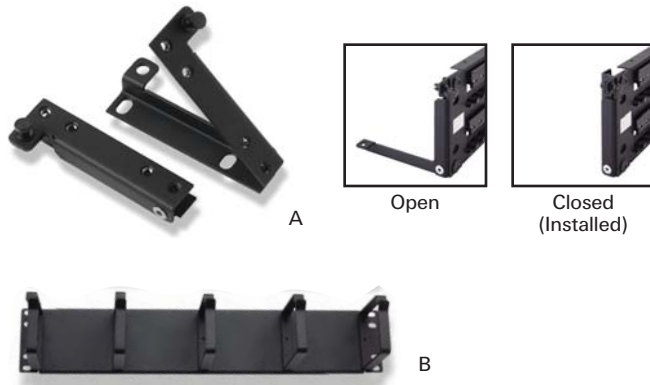

Description	Figure	Part Number
Patch Panel Hinge Kit	1U (1.75")	–
	2U (3.50")	A
Cable Management Panel for Hinged Patch Panels	1U (1.75")	–
	2U (3.50")	B

Product Facts

- For use with standard patch panels for hinged application where access behind patch panel is limited
- Hinged feature allows patch panel to be folded down for easy access to the back of the panel, while snapping securely into place for normal use
- Cable management panels have special ring spacing for hinged applications
- Hinged panels may not be stacked adjacent to one another in a rack without a cable management panel with a 1/2" of empty space between them

1.4

Cable Support Bars

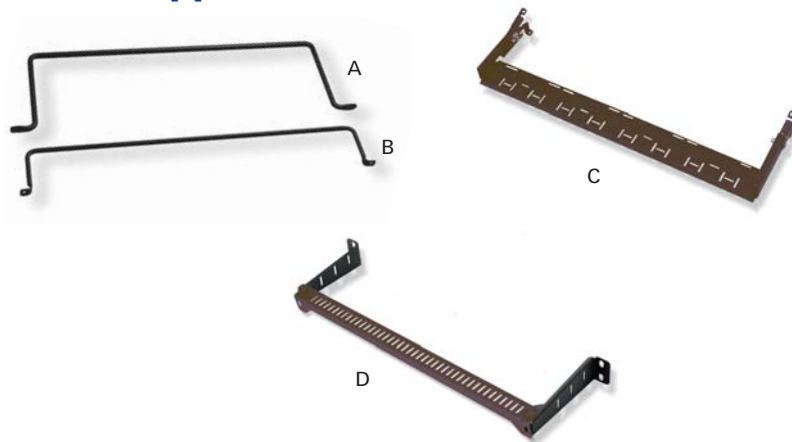

Description	Figure	Compatible with Panel	Part Number
Mounts to back of rack, 5" deep	A	(mounts to rack)	557548-1
Mounts to back of rack, 2" deep	B	(mounts to rack)	406042-1
Mounts to rear of Cable Management Panels	–	558329, 558331, 569049 406330, 406331, 406332	558301-1
Mounts to rear of 110Connect and SL Series Patch Panels	–	1475194, 1479155, 147155, 406981 1479156, 1375014, 1375015, 1375016, 1479449, 1479450, 1479206, 1479208	1479860-1
Mounts to rear of XG and SL Multimedia Patch Panels, 1U	C	1933307, 1933309, 1933319, 1933321, 1933331, 1933323	1933425-1
Cable Management Bar, 6" deep	D	(mounts to rack)	1933352-1
Cable Management Bar, 9" deep	–	(mounts to rack)	1933352-2
Cable Management Bar, 12" deep	–	(mounts to rack)	1933352-3
Cable Management Bar, 16" deep	–	(mounts to rack)	1933352-4

Product Facts

- Designed to provide additional cable support and routing control in the rear of 19" racks and panels
- Cable support bars that mount directly to rack provide the best support - other bars are available for specialty applications
- See support bar to patch panel compatibility chart

47

1.4

VELCRO Cable Ties



Product Facts

- For 8-inch and 12-inch ties, an order quantity of one equals one roll of ten ties

Description	Part Number
1" x 8"	1375253-X
1" x 12"	1375254-X
5/8" x 5 yards	1375255-X
1" x 12" Flame Retardant*	1375256-2

X denotes color: -2 = Black, -3 = White, -4 = Gray, -5 = Orange, -6 = Blue, -7 = Red, -8 = Yellow, -9 = Green, 1--0 = Violet

*Note: Complies with NEC 300-22(c) and (d) for use in environmental air handling spaces. Available in Black only.

AMP-TY Nylon Cable Ties



Dimensions (Approximate)			Minimum Tensile Strength	Maximum Bundle Diameter in(mm)	Package Quantity	Color	Part Number
Length in(mm)	Width in(mm)	Thickness in(mm)					
4 (103.0)	0.096 (2.44)	0.037 (0.94)	18 lbs 80.1 N	0.75 (19.10)	1000	Natural	2-604771-9
						Black	2-604771-0
6 (155.0)	0.140 (3.56)	0.045 (1.14)	30 lbs 133.5 N	1.25 (31.75)	1000	Natural	1-604771-9
						Black	1-604771-0
8 (204.0)	0.184 (4.67)	0.047 (1.19)	50 lbs 222.5 N	1.75 (44.45)	1000	Natural	2-603227-9
						Black	2-603227-0
12 (300.0)	0.183 (4.65)	0.051 (1.30)	50 lbs 222.5 N	3.00 (76.20)	1000	Natural	1-603227-9
						Black	1-603227-0
8 (204.0)	0.184 (4.67)	0.047 (1.19)	50 lbs 222.5 N	1.75 (44.45)	100	Natural	2-604772-9
						Black	2-604772-0
12 (300.0)	0.183 (4.65)	0.051 (1.30)	50 lbs 222.5 N	3.00 (76.20)	100	Natural	1-604772-9
						Black	1-604772-0
12 (300.0)	0.183 (4.65)	0.051 (1.30)	50 lbs 222.5 N	3.00 (76.20)	1000	Natural	2-604751-9
						Black	2-604751-0
12 (300.0)	0.183 (4.65)	0.051 (1.30)	50 lbs 222.5 N	3.00 (76.20)	100	Natural	1-604751-9
						Black	1-604751-0

Hinged Wall Brackets for 19-Inch Panels

Panel Height	Part Number 6" Depth
1U (1.75")	558266-1
2U (3.50")	558267-1
3U (5.25")	558268-1
4U (7.00")	558269-1

Product Facts

- Can be installed with hinges on either side for easier access
- Provided with cable tie laces to aid in dressing cables, have multiple threaded holes allowing more than one panel to be mounted on a bracket, and rear entry cable holes.

Hinged Wall Brackets for 19-Inch ACO Panels



Product Facts

- Can be installed with hinges on either side for easier access
- For use with ACO Patch Panels of matching panel height

Panel Height	Part Number *4" Depth
1U (1.75")	557396-1
2U (3.50")	555269-1
3U (5.25")	555273-1
4U (7.00")	555275-1
5U (8.75")	556205-1
6U (10.50")	555276-1

*Note: 4" depth brackets are for use with ACO patch panels of matching panel height only

Cover for Angled Patch Panels

PART NUMBER 1499614-1



Product Facts

- For use with angled patch panels
- Protects cabling from dust and damage
- Compatible with: 1499600, 1499601, 1499602, 1499603, 1499604, 1499605, 1933321, 1933322, 1933309, 1933310, 1499613, 1933333, 1933334, 1933329, 1933330, 1933325, 1933326 panels

1.4

Blank Panels



Height	Part Number
1U (1.75")	556965-1
2U (3.50")	556965-2
3U (5.25")	556965-3
4U (7.00")	556965-4
5U (8.75")	556965-5

Product Facts

- Standard 19" length panels are designed for use in filling equipment rack voids

Stationary, Ventilated Shelf

PART NUMBER 1435049-1

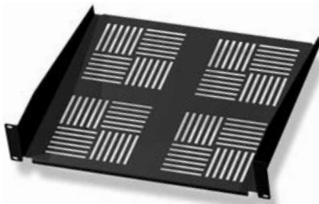

Product Facts

- Ventilation slots easily allow air flow
- 2U (3.50")
- Fits standard 19" racks
- Includes fastening hardware

Grounding Lug Kit

PART NUMBER 556438-1



Product Facts

- Use for grounding panels to locations other than rack
- Accommodates a maximum wire size of 6 AWG

C-LOK, Solid and Stranded Copper Bonding Connectors



Product Facts

- Connects solid or stranded copper conductors in grounding applications
- Installs quickly and safely without special tools
- Meets requirements of: Telcordia TR-NWT-001075; UL Listed; Canadian Standards Association
- Search C-LOK connectors at www.tycoelectronics.com for additional information and part numbers

50

CROSS-CONNECT SYSTEMS

610XC Category 6 Cross-Connect System	52-55
610XC Connecting Blocks	53
610XC Wiring Blocks	53
610XC Cross-Connect Kits	53
610XC Distribution Frame Kits	54
610XC Cable Management	54
610XC Rack Mount Cross-Connect Panel Kits	55
110Connect XC Category 5e Cross-Connect System	56-59
110Connect XC Connecting Blocks	56
110Connect XC Wiring Blocks	57
110Connect XC Cross-Connect Kits	57
110Connect XC Distribution Frame Kits	58
110Connect XC Cable Management	58
110Connect XC Rack Mount Cross-connect Panel Kits	59

Chapter Summary

- Support voice and data applications
- Standardized footprint for Category 5e and 6 applications for ease of system design
- UL Listed, CSA and Austel approved

1.5



1.5

610XC Category 6 Cross-Connect System



Product Facts

- Meets or exceeds TIA and ISO specifications for Category 6 component performance
- Features the same footprint and densities as standard 110Connect XC Cross-Connect System products
- Utilizes shielded crosstalk barrier technology for superior performance
- Totally new design – High tech black color and silver plating helps to differentiate between standard cross-connect and Category 6 products
- Supports applications from voice to high-speed data
- Compatible with standard 1-Pair tools as well as 610XC 4-Pair Tool (see Chapter 1.7)
- UL Listed
- CSA and Austel approved

52

610XC Cross-Connect Products

610XC 4- and 5-Pair Category 6 Connecting Blocks



Product Facts

- Utilize shielded crosstalk barrier technology for superior performance
- Utilize double-ended insulation displacement contacts (IDC) that terminates 24-22 AWG solid or stranded conductors with a maximum O.D. of .063"
- Available in 4- and 5-pair sizes with the appropriate color coding

Description	Part Number
4-Pair	1479245-1
5-Pair	1479246-1

1.5

610XC Category 6 Wiring Blocks

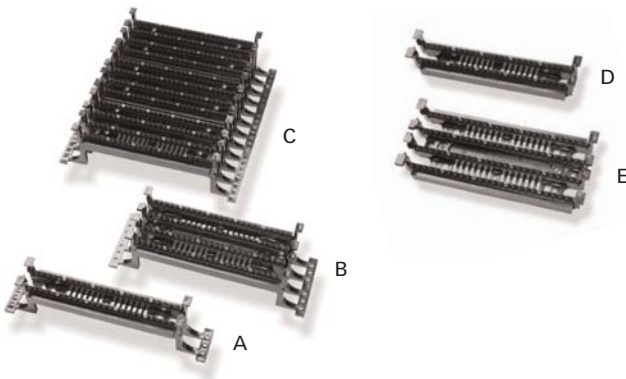

Product Facts

- Accepts 24-22 AWG conductors
- Available with and without legs
- Wiring blocks with legs are available in 50-, 100- and 300-pair sizes
- Wiring blocks without legs are available in 50- and 100-pair sizes
- Labels available (see Chapter 8)

Description	Figure	Part Number
With Legs	50-Pair A	1479247-1
	100-Pair B	1479248-1
	300-Pair C	1479249-1
Without Legs	50-Pair D	1479250-1
	100-Pair E	1479251-1

610XC Category 6 Cross-Connect Kits



Product Facts

- Kits include wiring blocks with legs, connecting blocks, designation strips, and white labels marked for the pair counts listed
- Additional labels available (see Chapter 8)

Description	Connecting Blocks	Part Number
50-Pair	4-Pair	1479252-1
	5-Pair	1479253-1
100-Pair	4-Pair	1479254-1
	5-Pair	1479255-1
300-Pair	4-Pair	1479256-1
	5-Pair	1479257-1

53

610XC Cross-Connect Products

1.5

610XC Category 6 Cross-Connect Distribution Frame Kits



Description	Connecting Blocks	Part Number
300-Pair	4-Pair	1479258-1
	5-Pair	1479259-1
900-Pair	4-Pair	1479260-1
	5-Pair	1479261-1

Product Facts

- Reduce time needed for planning and installing a cross-connect on a backboard
- Kits include metal back frame, wiring blocks without legs, connecting blocks, cable management troughs without legs, designation strips, white labels marked for the pair counts listed, grounding strap and appropriate hardware
- Additional labels available (see Chapter 8)
- Quick and easy installation
- Available in 300- and 900-pair sizes with either 4- or 5-pair connecting blocks

610XC Cable Management

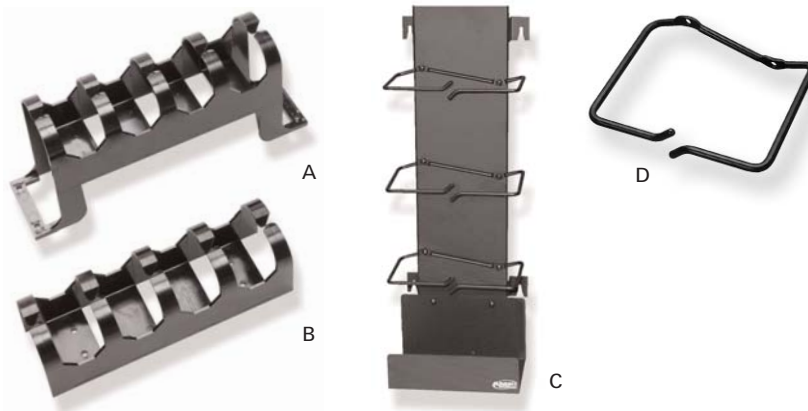

Description			Figure	Part Number
Cable Management Trough	Black	With Legs	A	569389-3
		Without Legs	B	569597-3
Vertical Cable Management Frame	Black	300-Pair	C	569851-3
		900-Pair	-	569852-3
Cable Management Rings	Black	5.7" W	D	569431-1
		8.5" W	-	569599-1

Product Facts

- Cable Management Frames and Cable Management Rings provide high capacity storage of patch cables and jumper wire
- Cable Management Trough provides horizontal management and organization of patch cables and jumper wire
- Troughs are available with or without legs
- Suitable for mounting directly to a plywood backboard
- Quick and easy installation

54

610XC Cross-Connect Products

610XC Rack Mount Cross-Connect Panel Kits



Product Facts

- For mounting 610XC hardware on a 19" rack
- Kits include wiring block panels, 4-Pair connecting blocks, designation strips and white labels for the pair counts listed
- Rack Mount Cable Management Panels provide horizontal management and organization of patch cables and jumper wire

1.5

Description	Pair Count	Connecting Blocks	Height	Width	Figure	Part Number
610XC Cross-Connect Rack Mount Panel Kits	100-Pair	4-Pair	1U (1.75")	19"	A	1479622-1
	200-Pair	4-Pair	2U (3.50")	19"	B	1479623-1
	400-Pair	4-Pair	5U (8.75")	19"	C	1479624-1
Cable Management Trough Rack Mount Panel			2U (3.50")	19"	-	406641-2

610XC Category 6 Cable Assemblies

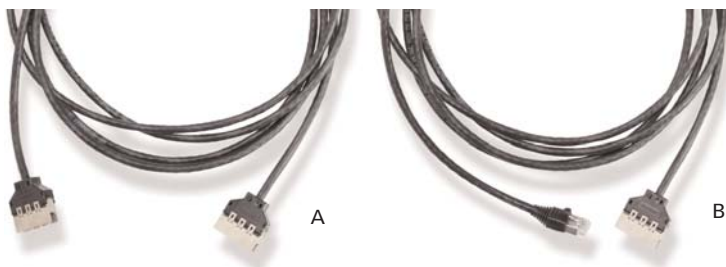

Product Facts

- Meets or exceeds Category 6 performance requirements
- Stranded unshielded, 24 AWG conductors, pair counts as listed
- Non-Plenum (CM rated)

Description	Figure	Part Number
610XC to 610XC	1-Pair	- 1479265-X
	2-Pair	- 1479266-X
	4-Pair	A 1479267-X
610XC to RJ45	4-Pair, T568A	B 1499414-X
	4-Pair, T568B	B 1499413-X

X denotes length in feet: -2 = 2, -4 = 4, -6 = 6, -8 = 8, 1-0 = 10

55

1.5

110Connect XC Category 5e Cross-Connect System

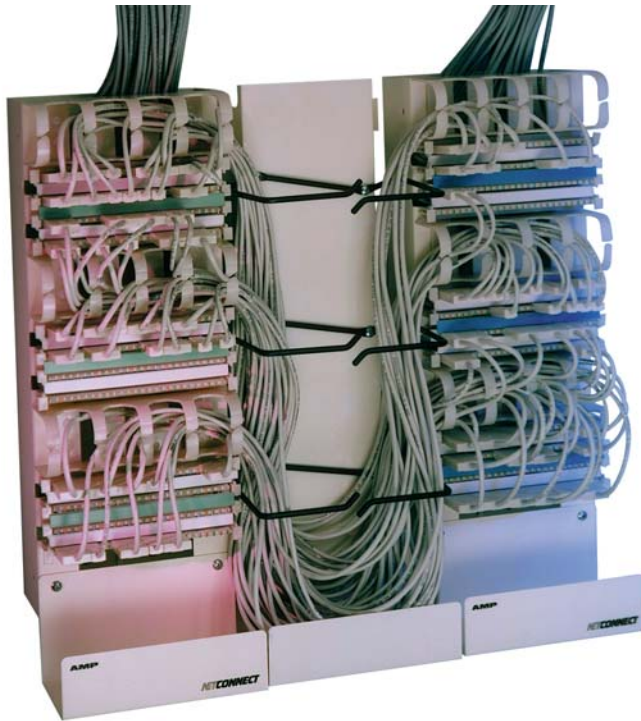

Product Facts

- Supports applications from voice to high-speed data
- Offers a reliable and economical high-density system
- Meets or exceeds the TIA specifications for Enhanced Category 5 (Category 5e)
- All components compatible with industry standard AMP NETCONNECT Impact Tools (see Chapter 1.7), the KRONE Tool and the 788J1 5-pair tool
- UL listed
- CSA and Austel approved

110Connect XC Category 5e Connecting Blocks

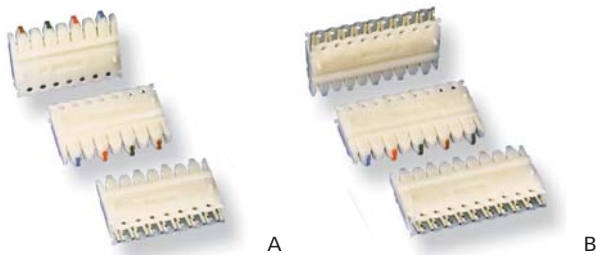

Product Facts

- Utilize double-ended insulation displacement contacts (IDC) that terminate 24-22 AWG solid or stranded conductors with a maximum O.D. of .063 inch
- Available in 3-, 4- and 5-pair sizes with the appropriate color coding

Description		Figure	Part Number
Connecting Blocks	3-Pair	–	558400-1
	4-Pair	A	558401-1
	5-Pair	B	558402-1

110Connect XC Cross-Connect Products

1.5

110Connect XC Category 5e Wiring Blocks

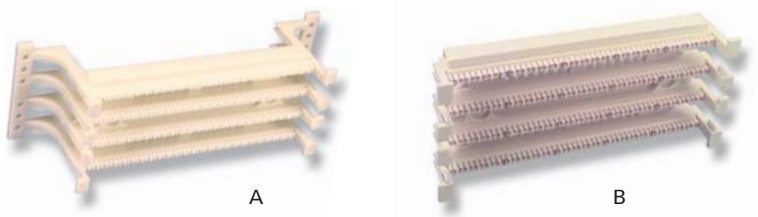

Product Facts

- Accept 24-22 AWG conductors
- Blocks are available in 50-, 100 and 300-pair sizes with legs for backboard mounting
- Labels available (see Chapter 8)

Description		Figure	Part Number
Wiring Blocks	With Legs	50-Pair	- 558841-1
		100-Pair	A 558842-1
		300-Pair	- 558843-1
	Without Legs	50-Pair	- 558839-1
		100-Pair	B 558840-1

110Connect XC Category 5e Kits

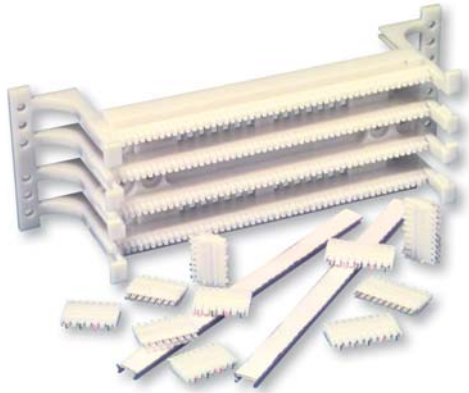

Product Facts

- Kits include wiring blocks with legs, connecting blocks, designation strips and white labels for the pair counts identified
- Additional labels available (see Chapter 8)

Description		Part Number
50-Pair	3- & 4-Pair Connecting Blocks	569432-1
	4- & 5-Pair Connecting Blocks	569433-1
	5-Pair Connecting Blocks	569434-1
100-Pair	3- & 4-Pair Connecting Blocks	569438-1
	4- & 5-Pair Connecting Blocks	569439-1
	5-Pair Connecting Blocks	569440-1
300-Pair	3- & 4-Pair Connecting Blocks	569444-1
	4- & 5-Pair Connecting Blocks	569445-1
	5-Pair Connecting Blocks	569446-1

Adapter for 89B Bracket PART NUMBER 558838-1

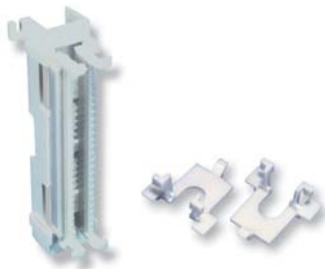

Product Facts

- Used to mount a 50-pair 110Connect XC wiring block on an 89B bracket
- Two adapters are required for each assembly
- Wiring blocks and 89B brackets purchased separately

57

110Connect XC Cross-Connect Products

1.5

110Connect XC Category 5e Cross-Connect Distribution Frame Kits



Product Facts

- Reduce time needed for planning and installing a cross-connect on a backboard
- Include metal back frame, wiring blocks, connecting blocks, cable management troughs, designation strips and appropriate hardware
- Quick and easy installation
- Available in 300- and 900-pair sizes with either 3-, 4- or 5-pair connecting blocks

Description	Connecting Blocks	Part Number
300-Pair	3- & 4-Pair	569853-1
	4- & 5-Pair	569854-1
	5-Pair	569855-1
900-Pair	3- & 4-Pair	569856-1
	4- & 5-Pair	569857-1
	5-Pair	569858-1

110Connect XC Cable Management

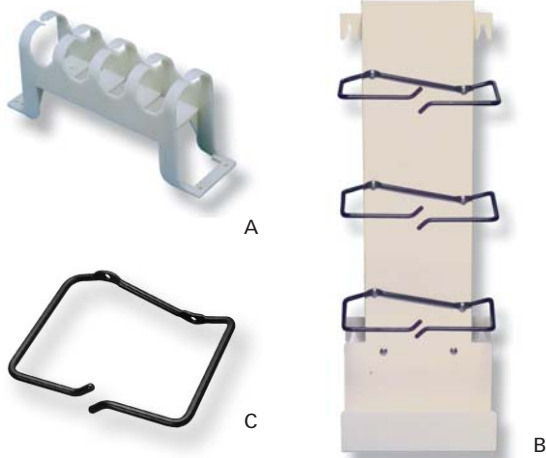

Product Facts

- Cable Management Frames and Cable Management Rings provide high capacity storage of patch cables and jumper wire
- Cable Management Trough provides horizontal management and organization of patch cables and jumper wire
- Troughs are available with or without legs
- Suitable for mounting directly to a plywood backboard
- Quick and easy installation

Description			Figure	Part Number
Cable Management Trough	White	With Legs	A	569389-1
		Without Legs	–	569597-1
Vertical Cable Management Frame	White	300-Pair	B	569851-1
		900-Pair	–	569852-1
Cable Management Rings	Black	5.7" W	C	569431-1
		8.5" W	–	569599-1

58

110Connect XC Cross-Connect Products

110Connect XC Category 5e Cross-Connect Rack Mount Panel

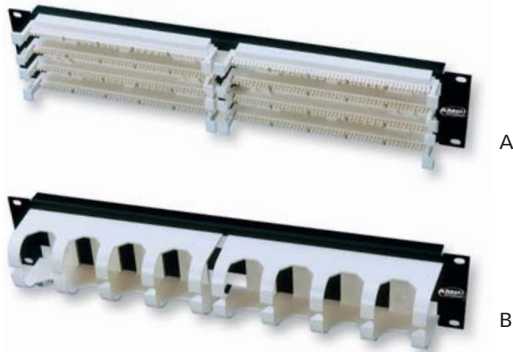

Product Facts

- For mounting cross-connect hardware on a 19" rack
- Wiring block and cable management panels available
- Labels available (see Chapter 8)
- Connecting blocks and plastic label covers purchased separately (see Chapter 8)
- Rack Mount Cable Management Panels provide horizontal management and organization of patch cables and jumper wire

1.5

Description	Pair Count	Height	Width	Figure	Part Number
110Connect XC Cross-Connect Rack Mount Panel Kits	100-Pair	1U (1.75")	19"	–	558635-1
	200-Pair	2U (3.50")	19"	A	558637-1
	400-Pair	5U (8.75")	19"	–	558639-1
Cable Management Trough Rack Mount Panel	–	2U (3.50")	19"	B	406641-1

110Connect XC Category 5e Cable Assemblies



Product Facts

- Meets or exceeds Category 5e performance requirements
- 4-Pair stranded unshielded, 24 AWG conductors
- Modular RJ45 plugs feature color-matched snagless boots
- 110Connect XC to RJ45 Patch Cable Assemblies must be selected to match wiring pattern of work area outlet wiring
- Non-Plenum (CM rated)
- Universal wiring (T568A/T568B)

Description	Pair Count	Wiring	Figure	Part Number
110Connect XC to 110Connect XC	1-Pair	–	–	569523-X
	2-Pair	–	–	569524-X
	3-Pair	–	–	569525-X
	4-Pair	–	A	569526-X
	4-Pair	T568A	B	569527-X
	4-Pair	T568B	B	569528-X
110Connect XC to RJ45	2-Pair	T568A, 10/100BASE-T	–	569685-X
	2-Pair	T568B, 10/100BASE-T	–	569669-X
	2-Pair	T568A, Token Ring	–	569686-X
	2-Pair	T568B, Token Ring	–	569672-X
	2-Pair	T568A, ATM/PMD	–	569687-X
	2-Pair	T568B, ATM/PMD	–	569673-X

X denotes length in feet: -2 = 2, -4 = 4, -6 = 6, -8 = 8, 1-0 = 10

59

Notes

1.5

60

DATA CENTER/SAN PRODUCTS

MRJ21 Cassettes	62
MRJ21 Cassette Panel	62
MRJ21 Patch Panels	63
Cable Support Bars	63
MRJ21 Cable Assemblies	64

1.6

Chapter Summary

- Application independent copper platform for applications today and into the future – including Gigabit, VoIP & powered Ethernet
- Small form factor MRJ21 connector and cabling reduces cable bulk in pathways and spaces, enabling much higher port counts in a smaller space
- Factory terminated and tested cassettes and patch panels allow pluggable performance on site
- Rapid installation or MACs with pre-tested quality
- Modularity significantly reduces time to install or migration from a 10/100BASE-T 2-pair platform to a Gigabit Ethernet 4-pair platform
- Upgrading is as simple as unplugging one cassette and plugging in the new one
- Cassettes and patch panels break out high-performance 24-pair solutions to the appropriate wiring patterns for standards-based 10/100BASE-T, Gigabit Ethernet, and other applications
- Common cable assembly lengths provide readily available, pluggable solutions, speeding implementation
- Additional hardware options continue to be released. Contact your sales engineer or check our website for the latest updates

1.6



61

1.6

MRJ21 Cassettes

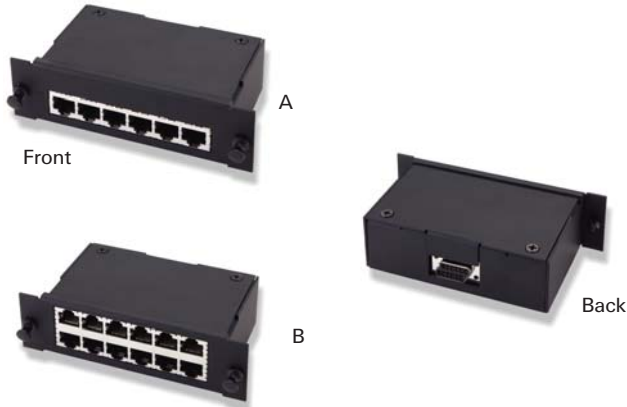

Product Facts

- High-performance copper cabling solution
- High-density, small form factor connectivity
- Factory terminated and tested
- Modular, pluggable design
- 6-Port cassettes support applications which use four or fewer pairs including 10BASE-T, 100BASE-T and 1000BASE-T
- 12-Port cassettes support applications which use two or fewer pairs including 10BASE-T, and 100BASE-T

Description	Applications	Figure	MRJ21 Connections	Part Number
Cassette 6-Port	10/100/1000BASE-T GbE (4-Pair)	A	1	1479459-1
Cassette 12-Port	10/100BASE-T (2-Pair)	B	1	1479452-1

MRJ21 Cassette Panel
PART NUMBER 1479451-1



Product Facts

- Accepts up to three (3) MRJ21 cassettes

Blank Adapter Plate
PART NUMBER 1777046-1



Product Facts

- Blank adapter plate for MRJ21 panel only
- Do not use this plate with Fiber enclosures

MRJ21 Patch Panels and Cable Support Bars

MRJ21 Patch Panels



A



B



C



Rear View

Product Facts

- High-performance copper cabling solution
- High-density, small form factor connectivity
- Factory terminated and tested
- Modular, pluggable design
- 4-Pair MRJ21 Patch Panels support applications which use four or fewer pairs including 10BASE-T, 100BASE-T and 1000BASE-T
- 2-Pair MRJ21 Patch Panels support applications which use two or fewer pairs including 10BASE-T, and 100BASE-T

1.6

Description	Applications	Height	Figure	MRJ21 Connections	Part Number	
Straight Patch Panels	24-Port	10/100/1000BASE-T GbE	1U	A	4	1777029-1
		(AMPTRAC Enabled) 10/100/1000BASE-T GbE	1U	-	4	1777029-2
	48-Port	10/100/1000BASE-T GbE	1U	B	8	1435971-1
		(AMPTRAC Enabled) 10/100/1000BASE-T GbE	1U	-	8	1777041-1
		10/100BASE-T	1U	-	4	1435965-1
	(AMPTRAC Enabled) 10/100BASE-T	1U	-	4	1777042-1	
Angled Patch Panels	48-Port	10/100/1000BASE-T GbE	1U	C	8	1777052-1
		(AMPTRAC Enabled) 10/100/1000BASE-T GbE	1U	-	8	1777053-1
Straight Label Holder Panel	(Labels not included)	1U	D	-	1777040-1	
Angled Label Holder Panel	(Labels not included)	1U	-	-	1777054-1	
Label Sheet	5 Sheets (22 panels)	-	-	-	1375354-X	
Label Sheet	100 Sheets (450 panels)	-	-	-	5-1375354-X	

X denotes label color: -1 = white, -2 = blue, -3 = green, -4 = purple, -5 = red, -6 = brown, -7 = yellow, -8 = orange, -9 = gray

Cable Support Bars



A

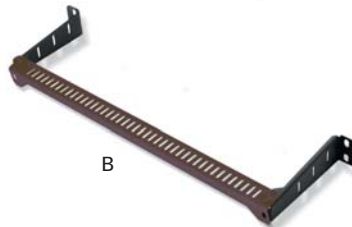

B

Product Facts

- Mounts to the back of 19" racks
- Designed to provide additional cable support and routing control behind 19" racks and panels
- MRJ21 slotted manager bar for easy tie down
- Horizontal and vertical mounting option for MRJ21 tie down bar

Description	Depth	Figure	Part Number
Standard Support Bar	5"	A	557548-1
	6"	B	1933352-1
MRJ21 Cable Manager Bar	9"	-	1933352-2
	12"	-	1933352-3
	16"	-	1933352-4
		-	

MRJ21 Cable Assemblies

1.6

MRJ21 Cable Assemblies



Product Facts

- Dense CHAMP style double blade design with offset jackscrews
- Contact layout and footprint for differential pairs creates reduced cross-talk and built in compensation
- 1.5 to 4 times the port density of 2x6 Stacked Modular Jack (RJ45)
- 3 times the port density of RJ21
- Jackscrews for positive latching and secure cable retention
- Common and custom cable assembly lengths are available - contact your local sales engineer for more information
- 25-Pair, unshielded, 24 AWG conductors
- CMR cable jacketing is gray
- CMP cable jacketing is blue

Connector A	Connector B	Rating	Figure	Part Number
MRJ21 (180° Back Shell)	MRJ21 (180° Back Shell)	CMR (Riser)	A	1499515-X
		CMP (Plenum)	-	1499518-X
	MRJ21 (45° Back Shell)	CMR (Riser)	-	1499517-X
		CMP (Plenum)	B	1933061-X
	RJ21 (45° Back Shell)	CMR (Riser)	-	1499516-X
		RJ21 (180° Back Shell)	CMP (Plenum)	-
Six RJ45 (GbE)	CMR (Riser)	C	1499520-X	
	CMP (Plenum)	-	1933056-X	
MRJ21 (45° Back Shell)	Six RJ45 (GbE)	CMR (Riser)	-	1499508-X

X denotes length in meters: -1 = 1, -2 = 2, -3 = 3, -4 = 4, -5 = 5, -6 = 6, -7 = 7, -8 = 8, -9 = 9, 1-0 = 10, 1-2 = 12, 1-5 = 15, 1-7 = 17, 2-0 = 20, 2-5 = 25, 3-0 = 30, 3-5 = 35, 4-0 = 40, 5-0 = 50, 6-0 = 60, 7-0 = 70, 8-0 = 80, 9-0 = 90

TWISTED PAIR TOOLS

SL Series Jack Termination Tool	67
110 Punch Down Termination Tools and Accessories	68
610XC Category 6 Cross-Connect 4-Pair Punch Down Tool	69
Palm Grip Tool	69
Cable Strippers	69
Diagonal Cutters	69
Modular Plug Tools	70
Pistol Grip Tool	71
CHAMP Tools	72-73
Twisted Pair Testing	74

Chapter Summary

- All tooling required to install twisted pair connectors found in this catalog

1.7



1.7

Die Set/Tool to Modular Plug Cross-Reference

Modular Plug	Modular Plug Tool Kits			Individual Modular Plug Die Sets for Hand Tool 2-231652-0			
	790163-1	790163-5	1-231666-4	1-853400-0	853400-1	853400-7	853400-8
1479583	-	-	X	X	-	-	-
1479584	-	-	X	X	-	-	-
1479585	-	-	X	X	-	-	-
1479586	-	-	X	X	-	-	-
1479682	X	-	-	-	-	-	-
1479683	X	-	-	-	-	-	-
1479185	-	X	-	-	-	-	-
1479184	-	X	-	-	-	-	-
1375202	X	-	-	-	-	-	-
1375204	X	-	-	-	-	-	-
554169	-	-	X	-	X	-	-
554170	-	-	X	-	X	-	-
554710	-	-	X	-	-	-	X
554720	-	-	X	-	X	-	-
554739	-	-	X	-	X	-	-
555042	-	-	X	-	-	-	X
555174	-	-	X	-	-	X	-
555175	-	-	X	-	-	X	-
555177	-	-	X	-	-	X	-
555417	-	-	X	-	X	-	-
555426	-	-	X	-	-	X	-
557315	-	-	X	-	X	-	-
558530	-	-	X	X	-	-	-
569278	-	-	X	X	-	-	-
569550	-	-	X	X	-	-	-
569552	-	-	X	X	-	-	-
569530	-	-	X	-	X	-	-
569532	-	-	X	-	X	-	-
569542	-	-	X	-	-	-	X
641337	-	-	X	-	-	-	X

SL Series Modular Jack Tool

SL Series Modular Jack Termination Tool and Accessories



Product Facts

- Termination tool for SL Series Jacks
- Simplifies the termination process, especially for Category 6 Jacks
- Terminates and cuts all 8 conductors at once
- Simplifies lacing process and speeds up terminations
- Tool without Lacing Fixture is for use with SL Series AMP-TWIST 6A Modular Jacks

1.7

Description		Part Number
SL Series Modular Jack Termination Tool	With Lacing Fixture	1725150-1
	Without Lacing Fixture	1725150-3
Replacement Lacing Fixture		1673956-1

SL Series Modular Jack Termination Tool UTP Termination Method

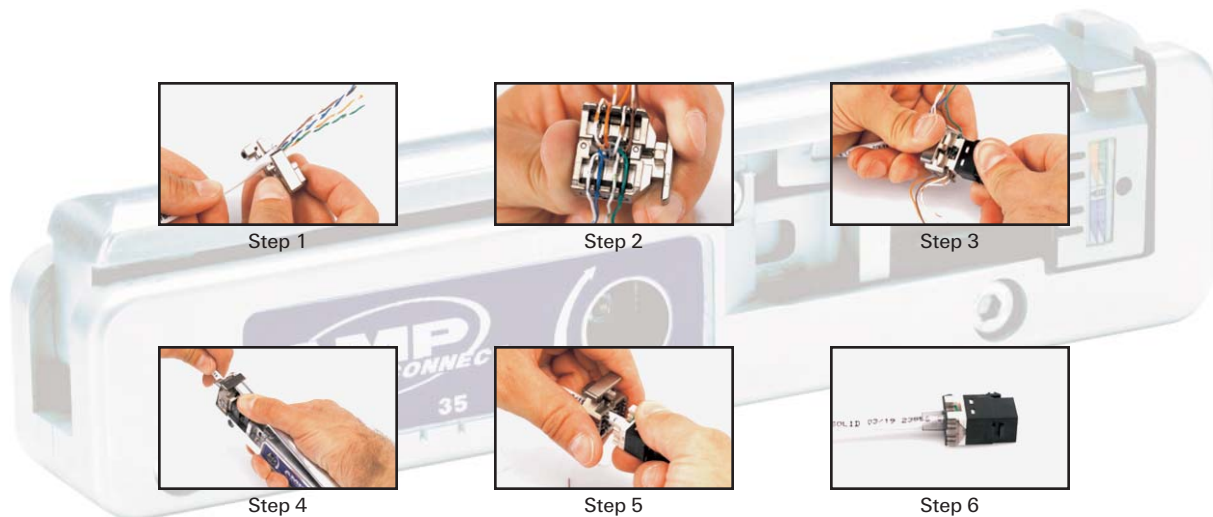

67

110 Punch Down Tools and Accessories

1.7

Pro-Installer Twisted Pair Tool Kit

PART NUMBER 1375307-1



Product Facts

- Includes:
 - Installer's knife
 - Pro Impact Tool with extended-life blade
 - Shears
 - AMP NETCONNECT tool pouch
- For use with 110Connect and SL Series Modular Jacks and other 110-Style terminations

110 Punch Down Tools with Blades



Product Facts

- The industry standard termination tool for all 110Connect terminations
- Each tool comes with a blade
- For use with 110Connect and SL Series Modular Jacks and other 110-Style terminations

Description	Figure	Part Number
Pro Impact Tool with Extended-Life Blade	A	1375308-1
Standard Impact Tool with Standard Blade	B	1583608-2
Non-Impact Tool with Standard Blade	C	1583236-1

110 Punch Down Tool Replacement Blades



Product Facts

- Extended-life blades have a lifetime 3 times longer than standard blades

Description	Figure	Part Number
Extended-Life 110 Blade	A	1375309-1
Extended-Life 66/110 Blade	B	1375310-1

610XC 4-Pair Tool and Accessories for Twisted Pair Termination

610XC 4-Pair Punch Down Tool

PART NUMBER 1725062-1



Product Facts

- For use with AMP NETCONNECT Category 6 610XC Cross-Connects
- Used to:
 - Punch down 4-pairs of conductors at one time
 - Punch down 610XC 4- and 5-Pair Connecting Blocks onto 610XC Wiring Blocks

1.7

Palm Grip Tool

PART NUMBER 569949-1



Product Facts

- Fits comfortably into one hand
- Holds one 110Connect Jack, one SL Series 110Connect Jack, or ACO 110 Card Edge Connector for termination

Cable Strippers and Cutters

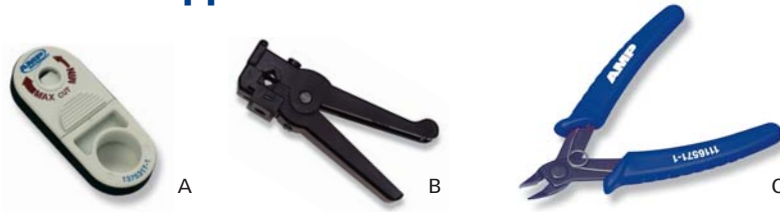

Product Facts

- Cyclops Stripper suitable for use with UTP Cable
- Coaxial Stripper can be adjusted for use with RG-6, -58 and -59 cable

Description	Figure	Part Number
Cyclops Cable Stripper	A	1375317-1
Coaxial Cable Stripper	B	1490490-1
Diagonal Cutters	C	1116571-1

Modular Plug Tools

1.7

PRO-CRIMPER III Hand Tool and Die Sets for Twisted Pair Applications



PRO-CRIMPER III
(shown with a die set)

Description	Part Number	
PRO-CRIMPER III Hand Tool	354940-1	
External Strain Relief Clamp	Hand Tool and Die Set	224928-1
	Die Set Only	224928-2

Product Facts

- External Strain Relief Clamp Die Set and Tool are for use with the External Strain Relief Clamp for 8-position Category 3, 5, and 5e Modular Plugs (Chapter 1.2) only

Category 6 Modular Plug Hand Tool and Die Set

Description	Cable O.D.	Part Number	
Category 6 Modular Plug	5 – 6 mm	Hand Tool and Die Set	790163-1
		Die Set Only	790163-2
	6 – 7 mm	Hand Tool and Die Set	790163-5
		Die Set Only	790163-6

Product Facts

- Category 6 Modular Plug Die Set and Tool crimps both the Strain Relief and the Modular Plug contacts at the same time
- Category 6 Modular Plugs in Chapter 1.2

Pro-Installer’s Modular Plug Hand Tool



Product Facts

- Ratchet control provides complete termination cycle
- Interchangeable die sets accommodate all plug sizes
- Die set to Modular Plug cross-reference on page 66
- Clamshell packaging is made of clear plastic and is for point-of-purchase display

Description	Color Dot	Packaging		Part Number
4-Position Handset	Green	Hand Tool and Die Set	Standard	2-231652-3
		Die Set Only	Clamshell	853400-3
4- and 6-Position Line	Blue	Hand Tool and Die Set	Clamshell	2-231652-4
		Die Set Only	Standard	2-231652-8
6-Position Offset Latch	Orange	Hand Tool and Die Set	Clamshell	853400-8
		Die Set Only	Standard	2-231652-6
6-Position Long Body	Violet	Hand Tool and Die Set	Clamshell	853400-6
		Die Set Only	Standard	2-231652-7
8-Position Line	Black	Hand Tool and Die Set	Clamshell	853400-7
		Die Set Only	Standard	2-231652-1
8-Position High Performance	White	Hand Tool and Die Set	Clamshell	2-231652-2
		Die Set Only	Clamshell	853400-1
		Hand Tool and Die Set	Standard	3-231652-0
		Die Set Only	Clamshell	3-231652-1
		Die Set Only	Clamshell	1-853400-0

70

Modular Plug Tools and Pistol Grip Tool

Pro-Installer's Modular Plug Hand Tool Kits and Accessories



Product Facts

- Each Kit contains Carrying Case, Blade Replacement Kit, Screw Driver, and items as listed
- Modular Plug to Die Set cross reference listed on page 66

1.7

Kits Contain						
Hand Tool 2-231652-0	High Performance, 8-Position Die Set 1-853400-0	8-Position Line Die Set 853400-1	6-Position, Long Body Die Set 853400-7	4- & 6-Position Line Die Set 853400-8	4-Position Handset Die Set 853400-3	Part Number
X	X	X	X	X	-	1-231666-4
X	-	X	X	X	X	1-231666-3
X	-	X	X	X	-	1-231666-2
X	-	X	-	X	X	1-231666-1
X	-	X	-	X	-	1-231666-0
Carrying Case, Blade Replacement Kit and Screw Driver ONLY						231666-9
Replacement Blade Kit (5 Cutters and 5 sets of Strip Blades)						231662-5
Cutter Blade						856727-1

Pistol Grip Tool for AMP-BARREL Edge Connectors

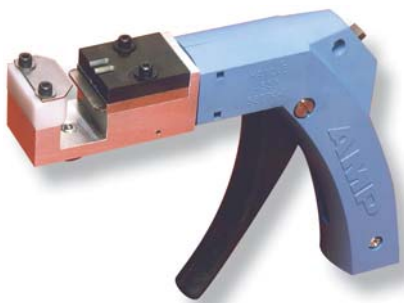

Product Facts

- The Pistol Grip Tool terminates AMP-BARREL Edge Connectors one pair at a time
- Shortens assembly time by trimming conductors to the proper length and helps maintain proper pair twist for high performance cables
- This tool requires the installation kit to be fitted with a special edge connector, part number 406351-1

Description	Part Number
Pistol Grip Tool with Head	58568-1
Head only	122533-1

71

AMP-BARREL Edge Connector and 25-Pair Connector Tools

1.7

AMP-BARREL Wire Insertion Tools



For Use With:	Figure	Part Number
ACO Edge Connectors	A	556706-1
Wire Insertion Tool for UC Transition Blocks	B	231890-1

Product Facts

- Wire Insertion Tool for Edge Connectors may be used to insert and terminate wires into the special edge connector (Chapter 3) for use with the pistol grip tool
- Wire Insertion Tools for Undercarpet Transition Blocks may be used to insert and terminate wires into AMP-BARREL connectors used in Undercarpet Cabling System Transition Blocks
- Wire Insertion Tools for Undercarpet Transition Blocks cuts off conductor when it is inserted

Compression Tool for AMP-BARREL Edge Connectors
PART NUMBER 1085 CT



Product Facts

- Provides improved termination of AMP-BARREL Connectors compared to standard pliers
- May also be used with KEYSTONE Modular Jacks
- Tool can be purchased from:
Rostra Tool Co.
30 East Industrial Road
Branford, CT 06405
Phone: 1-203-488-8665

Portable "Butterfly" Hand Tool (MI-1) for CHAMP 25-Pair Connectors



Description	Part Number
Standard 14-50 Positions, 90° Wire Dress	229378-1
Optional Lacing Fixture	230328-3

Product Facts

- Mass terminates and shears all wires in a single operation
- Wires can be laced in tool or in separate lacing fixture
- Base plate can be bench-mounted

72

Tools for 14- to 64-Position Connectors

Palm Grip Hand Tool Kits



Product Facts

- 14- to 64-Position Kit includes Wire Inserter, all 5 sizes of Index Slides, Cable Clamp, Insertion/Extraction Tool (230238-1), and carrying case
- 50-Position Kit includes wire inserter, 50-position index slide and cable clamp

1.7

Description	Part Number
14- to 64-Position	229764-2
50-Position only	229451-2

Insertion/Extraction Tools

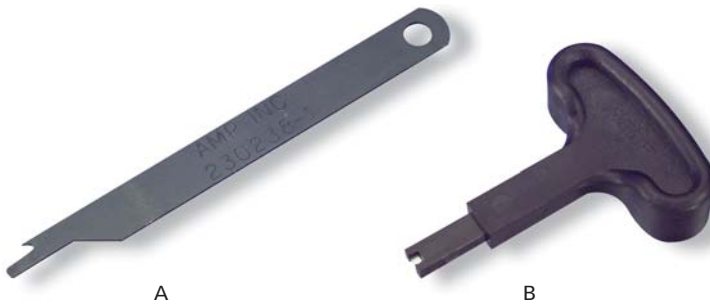

Product Facts

- Used with CHAMP Connectors
- Wire insertion tool is used to insert individual wires when making repairs
- Contact insertion/extraction tool is used to replace damaged contacts

Description	Figure	Part Number
Contact Insertion/Extraction Tool	A	230238-1
T-Handle Wire Insertion Tool	B	229384-1

73

Twisted Pair Testing Tools

1.7

Twisted Pair Testing Tools



A



B



C



D

Product Facts

- 4-Pair UTP Tester:
 - Tests for opens, shorts and wire map (mis-wires, reversals, and split pairs)
 - Auto-on/off feature
 - Battery low indicator
- Butt Set:
 - LCD display shows: on-hook voltage, number dialed, off-hook current, caller ID, stored numbers, etc.
 - Tone and pulse dialing
 - 6-Position modular cord set attachment included
 - Auto-off feature
- Tone Generator:
 - Three built-in tones
 - Auto-off feature
 - Separate talk battery for increased voltage and power for test sets
 - 6-Position modular jack allows multiple cord/test lead sets to be used for different applications
 - Comes with test lead set
- Tone Tracer:
 - Permits wire and cable identification without direct metallic contact
 - Ergonomic design
 - Can be used with any tone generator
 - Quick change tips available

Description	Figure	Part Number
4-Pair UTP Tester	A	1490530-1
Butt Set	B	1490532-1
Tone Generator	C	1490531-1
Tone Tracer	D	1490533-1

OPTICAL FIBER PRODUCTS

2.1 Optical Fiber Cables and Accessories	76-88
2.2 Connectors, Mechanical Splices, Couplers & Adapters	89-102
2.3 Optical Fiber Cable Assemblies	103-112
2.4 Optical Fiber Data Center/SAN Products	113-118
2.5 Rack Mount Enclosures and Accessories	119-128
2.6 Wall Mount Enclosures & Accessories	129-134
2.7 Optical Fiber Tools & Accessories	135-148

2.1

2.1

OPTICAL FIBER CABLES AND ACCESSORIES

Distribution, 6-12 Fiber	77
Distribution, 24-72 Fiber	78
Indoor/Outdoor, 4-12 Fiber	79
Indoor/Outdoor, 24-144 Fiber	80
Outside Plant Dielectric, 4-12 Fiber	81
Outside Plant Dielectric, 24-144 Fiber	82
Outside Plant Armored, 4-12 Fiber	83
Outside Plant Armored, 24-144 Fiber	84
Interlocking Jacketed Aluminum Armored Cable	85
Horizontal, 2-4 Fiber	86
Interconnect, 1-2 Fiber	87

Chapter Summary

- Riser and Plenum Horizontal, Interconnect, Distribution and Indoor/Outdoor Cables
- All-dielectric and Armored Outside Plant Cables

75

Optical Fiber Cable Performance

2.1

AMP NETCONNECT Optical Fiber Cables

AMP NETCONNECT optical fiber cables contain high quality optical fiber and offer excellent performance for LED-based, laser-based, and VCSEL-based (ex: Gigabit Ethernet and 10 Gigabit Ethernet) applications. AMP NETCONNECT multimode optical fibers offer performance beyond the IEEE 802.3z distances for Gigabit Ethernet, and support IEEE 802.3ae distances for Ten Gigabit Ethernet while still supporting slower protocols such as Fast Ethernet and FDDI.

The AMP NETCONNECT XG Optical Fiber System is a high performance cabling system which has been designed to meet or exceed the requirements of the 10 Gigabit Ethernet application while still supporting all legacy LED and VCSEL applications. The system fulfills the specifications of IEEE 802.3ae for 10GBASE-SR (10 Gigabit Ethernet serial transmission on MMF at 850nm) and complies to the OM-3 fiber type and link class definitions of the 2nd edition of ISO 11801. All AMP NETCONNECT XG Optical Fiber System components have been designed and optimized to offer a complete, end-to-end system to support today's applications and provide an easy migration to higher data rates.

Product Facts

- AMP NETCONNECT Optical Fiber Cables are tested and designed to the most recent applicable industry standards for premise cabling, network and telecommunications applications, including:

IEEE 802.3 Ethernet	TIA/EIA-568
Fast Ethernet	ISO 11801
Gigabit Ethernet	ICEA-596
10 Gigabit Ethernet	ICEA-640
FDDI	ICEA-696
ATM	IEC 793-1
Fibre Channel	IEC 794-1
Token Ring	Telecordia GR-409-CORE
	Telecordia GR-20-CORE

Fiber	Gigabit Ethernet @ 850 nm	Gigabit Ethernet @ 1300 nm	10 Gigabit Ethernet Serial @ 850 nm	10 Gigabit Ethernet WDM @ 1300 nm
Multimode 62.5/125 μm	300 m	550 m	33 m	300 m
Multimode 50/125 μm	600 m	600 m	82 m	300 m
XG (850nm Laser-optimized 50/125 μm) Multimode	1000 m	600 m	300 m	300 m

Optical Fiber Cable Specifications

	Single-mode (1300/1550 nm)	XG (850 nm LO 50/125 μm Multimode (850/1300 nm)	Multimode 50/125 μm (850/1300 nm)	Multimode 62.5/125 μm (850/1300 nm)
Indoor Cables				
Maximum Attenuation (dB/km)	0.7/0.7	3.5/1.5	3.5/1.5	3.5/1.5
OFL Bandwidth (MHz·km)	-/-	1500/500	500/500	200/500
Laser Bandwidth (MHz·km)	-/-	2000/-	-/-	-/-
Indoor/Outdoor and OSP Loose Tube Cables				
Maximum Attenuation (dB/km)	0.5/0.5	3.5/1.5	3.5/1.5	3.5/1.5
OFL Bandwidth (MHz·km)	-/-	1500/500	500/500	200/500
Laser Bandwidth (MHz·km)	-/-	2000/-	-/-	-/-

Optical Fiber Cable Temperature Ranges

		Riser	Plenum
Interconnect (Tight Buffered) Cables	Storage	-40°C to +65°C (-40°F to +149°F)	-40°C to +65°C (-40°F to +149°F)
	Operating	-20°C to +50°C (-4°F to +122°F)	-20°C to +50°C (-4°F to +122°F)
	Installation	-20°C to +50°C (-4°F to +122°F)	-20°C to +50°C (-4°F to +122°F)
Indoor, Distribution (Tight Buffered) Cables	Storage	-40°C to +65°C (-40°F to +149°F)	-40°C to +65°C (-40°F to +149°F)
	Operating	-20°C to +50°C (-4°F to +122°F)	0°C to +50°C (32°F to +122°F)
	Installation	-20°C to +50°C (-4°F to +122°F)	0°C to +50°C (32°F to +122°F)
Indoor/Outdoor Cables	Storage	-40°C to +70°C (-40°F to +160°F)	-40°C to +70°C (-40°F to +160°F)
	Operating	-40°C to +70°C (-40°F to +160°F)	-40°C to +70°C (-40°F to +160°F)
	Installation	-20°C to +60°C (-4°F to +140°F)	-0°C to +60°C (-32°F to +140°F)
Stranded Cables			
OSP (Loose Tube) Cables	Storage	-40°C to +70°C (-40°F to +160°F)	
	Operating	-40°C to +70°C (-40°F to +160°F)	
	Installation	-20°C to +60°C (-4°F to +140°F)	

76

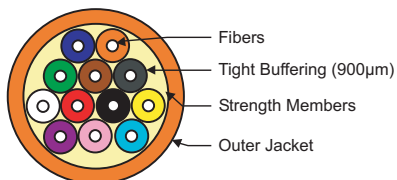
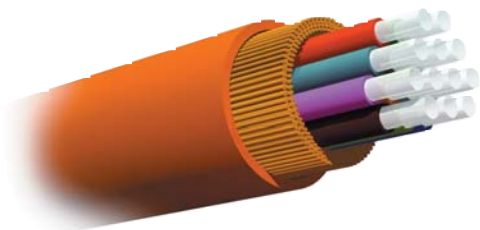

Product Facts

- Suitable for horizontal and in-building backbone cabling and for direct termination with epoxy/polish, LightCrimp, LightCrimp PLUS and MT-RJ jacks
- Strippable 900 µm tight buffer coating allows for easy connectorization
- TIA color-coded fibers for easy identification
- UL and cUL listed OFNR (Riser) and OFNP (Plenum)
- Outer Jacket Color:
 - Single-mode: Yellow
 - 50/125 and 62.5/125 µm: Orange
 - XG 50/125 µm: Aqua

Distribution Cables

Fiber Count	Unit Count Unit (Fibers/Unit)	Fiber Type	UL/NEC Ratings	Part Number	Weight kg/km (lb/kft)	Diameter mm (in)	Tensile Load N (lbf)		Bending Radius mm (in)	
							Installation	Long Term	Installation	Long Term
6	1 (6)	Single-mode	Riser	0-1664036-6	22 (15)	4.8 (0.19)	667 (150)	167 (38)	96 (3.8)	48 (1.9)
			Plenum	0-1664037-6	24 (16)		445 (100)	111 (25)		
		Multimode 50/125 µm	Riser	2-1664038-1	22 (15)		667 (150)	167 (38)		
			Plenum	2-1664039-1	24 (16)		445 (100)	111 (25)		
		XG Multimode 50/125 µm	Riser	8-1664038-9	22 (15)		667 (150)	167 (38)		
			Plenum	8-1664039-9	24 (16)		445 (100)	111 (25)		
8	1 (8)	Single-mode	Riser	0-1664042-6	24 (16)	4.9 (0.19)	667 (150)	167 (38)	108 (4.2)	54 (2.1)
			Plenum	0-1664043-6	26 (18)		445 (100)	111 (25)		
		Multimode 50/125 µm	Riser	2-1664044-1	24 (16)		667 (150)	167 (38)		
			Plenum	2-1664045-1	26 (18)		445 (100)	111 (25)		
		XG Multimode 50/125 µm	Riser	8-1664044-9	24 (16)		667 (150)	167 (38)		
			Plenum	8-1664045-9	26 (18)		445 (100)	111 (25)		
12	1 (12)	Single-mode	Riser	0-1664048-6	36 (24)	6.2 (0.24)	667 (150)	167 (38)	124 (4.8)	62 (2.4)
			Plenum	0-1664049-6	46 (31)		445 (100)	111 (25)		
		Multimode 50/125 µm	Riser	2-1664050-1	36 (24)		667 (150)	167 (38)		
			Plenum	2-1664051-1	46 (31)		445 (100)	111 (25)		
		XG Multimode 50/125 µm	Riser	8-1664050-9	36 (24)		667 (150)	167 (38)		
			Plenum	8-1664051-9	46 (31)		445 (100)	111 (25)		
Multimode 62.5/125 µm	Riser	1-1664052-1	36 (24)	667 (150)	167 (38)					
	Plenum	1-1664053-1	46 (31)	445 (100)	111 (25)					
	1 SM (6)	Hybrid - SM	Riser	3-1664405-9	36 (24)		667 (150)	167 (38)		
	1 MM (6)	XG 50/125 µm	Plenum	3-1664404-9	46 (31)		445 (100)	111 (25)		

Distribution, 24-72 Fiber

2.1

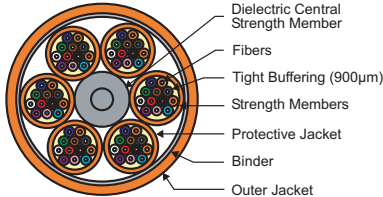

Multi-unit Distribution Cables



Product Facts

- Suitable for horizontal and in-building backbone cabling and for direct termination with epoxy/polish, LightCrimp, LightCrimp PLUS and MT-RJ jacks
- Hybrid cables (with single-mode and multimode fibers) are available to provide a built-in migration path for future applications that will require single-mode fibers
- Strippable 900 µm tight buffer coating allows for easy connectorization
- TIA color-coded fibers for easy identification
- UL and cUL listed OFNR (Riser) and OFNP (Plenum)
- Outer Jacket Color:
 - Single-mode: Yellow
 - 50/125 and 62.5/125 µm: Orange
 - XG 50/125 µm: Aqua

Fiber Count	Unit Count Unit (Fibers/Unit)	Fiber Type	UL/NEC Ratings	Part Number	Weight kg/km (lb/kft)	Diameter mm (in)	Tensile Load N (lbf)		Bending Radius mm (in)						
							Installation	Long Term	Installation	Long Term					
24	2 (12)	Single-mode	Riser	0-1664054-6	87 (59)	7.2 x 13.4 (0.28 x 0.53)	1335 (300)	334 (75)	144 (5.6)	72 (2.8)					
			Plenum	0-1664055-6	117 (79)		667 (150)	167 (38)							
		Multimode 50/125 µm	Riser	2-1664056-1	87 (59)		1335 (300)	334 (75)							
			Plenum	2-1664057-1	117 (79)		667 (150)	167 (38)							
		XG Multimode 50/125 µm	Riser	8-1664056-9	87 (59)		1335 (300)	334 (75)							
			Plenum	8-1664057-9	117 (79)		667 (150)	167 (38)							
	1 SM (12) 1 MM (12)	Multimode 62.5/125 µm	Riser	1-1664058-1	87 (59)		1335 (300)	334 (75)							
			Plenum	1-1664059-1	117 (79)		667 (150)	167 (38)							
		Hybrid - SM 62.5/125 µm	Riser	4-1664084-1	87 (59)		1335 (300)	334 (75)							
			Plenum	4-1664085-1	117 (79)		667 (150)	167 (38)							
		Hybrid - SM 62.5/125 µm	Riser	3-1664407-9	87 (59)		1335 (300)	334 (75)							
			Plenum	3-1664406-9	117 (79)		667 (150)	167 (38)							
36	4 (6)	Single-mode	Riser	0-1664060-6	160 (109)	13.2 (0.52)	1335 (300)	334 (75)	201 (8.0)	134 (5.3)					
			Plenum	0-1664061-6	200 (140)		667 (150)	167 (38)							
		Multimode 50/125 µm	Riser	2-1664062-1	160 (109)		1335 (300)	334 (75)							
			Plenum	2-1664063-1	200 (140)		667 (150)	167 (38)							
		XG Multimode 50/125 µm	Riser	8-1664062-9	160 (109)		1335 (300)	334 (75)							
			Plenum	8-1664063-9	200 (140)		667 (150)	167 (38)							
	2 SM (6) 2 MM (6)	Multimode 62.5/125 µm	Riser	1-1664064-1	160 (109)		1335 (300)	334 (75)							
			Plenum	1-1664065-1	200 (140)		667 (150)	167 (38)							
		Hybrid - SM 62.5/125 µm	Riser	4-1664086-1	160 (109)		1335 (300)	334 (75)							
			Plenum	4-1664087-1	200 (140)		667 (150)	167 (38)							
		6 (6)	Single-mode	Riser	0-1664066-6		210 (140)	16.4 (0.65)			1335 (300)	334 (75)	348 (13.8)	174 (6.9)	
				Plenum	0-1664067-6		260 (180)				667 (150)	167 (38)			
Multimode 50/125 µm	Riser		2-1664068-1	210 (140)	1335 (300)	334 (75)									
	Plenum		2-1664069-1	260 (180)	667 (150)	167 (38)									
XG Multimode 50/125 µm	Riser		8-1664068-9	210 (140)	1335 (300)	334 (75)									
	Plenum		8-1664069-9	260 (180)	667 (150)	167 (38)									
2 SM (6) 4 MM (6)	Multimode 62.5/125 µm	Riser	1-1664070-1	210 (140)	1335 (300)	334 (75)									
		Plenum	1-1664071-1	260 (180)	667 (150)	167 (38)									
	Hybrid - SM 62.5/125 µm	Riser	4-1664088-1	210 (140)	1335 (300)	334 (75)									
		Plenum	4-1664089-1	260 (180)	667 (150)	167 (38)									
	48	4 (12)	Single-mode	Riser	0-1664072-6	250 (170)	18.2 (0.72)		1335 (300)	334 (75)	360 (14.2)	180 (7.1)			
				Plenum	0-1664073-6	310 (210)			667 (150)	167 (38)					
Multimode 50/125 µm			Riser	2-1664074-1	250 (170)	1335 (300)		334 (75)							
			Plenum	2-1664075-1	310 (210)	667 (150)		167 (38)							
XG Multimode 50/125 µm			Riser	8-1664074-9	250 (170)	1335 (300)		334 (75)							
			Plenum	8-1664075-9	310 (210)	667 (150)		167 (38)							
2 SM (12) 2 MM (12)		Multimode 62.5/125 µm	Riser	1-1664076-1	250 (170)	1335 (300)		334 (75)							
			Plenum	1-1664077-1	310 (210)	667 (150)		167 (38)							
		Hybrid - SM 62.5/125 µm	Riser	3-1664409-9	250 (170)	1335 (300)		334 (75)							
			Plenum	3-1664408-9	310 (210)	667 (150)		167 (38)							
		72	6 (12)	Single-mode	Riser	0-1664078-6		380 (260)	22.0 (0.86)	1335 (300)			334 (75)	432 (17.0)	216 (8.5)
					Plenum	0-1664079-6		460 (310)		667 (150)			167 (38)		
Multimode 50/125 µm	Riser			2-1664080-1	380 (260)	1335 (300)	334 (75)								
	Plenum			2-1664081-1	460 (310)	667 (150)	167 (38)								
XG Multimode 50/125 µm	Riser			8-1664080-9	380 (260)	1335 (300)	334 (75)								
	Plenum			8-1664081-9	460 (310)	667 (150)	167 (38)								
2 SM (12) 4 MM (12)	Multimode 62.5/125 µm		Riser	1-1664082-1	380 (260)	1335 (300)	334 (75)								
			Plenum	1-1664083-1	460 (310)	667 (150)	167 (38)								
	Hybrid - SM 62.5/125 µm		Riser	4-1664090-1	380 (260)	1335 (300)	334 (75)								
			Plenum	4-1664091-1	460 (310)	667 (150)	167 (38)								

NOTE: Other hybrid fiber count combinations are available - call for more information.

78

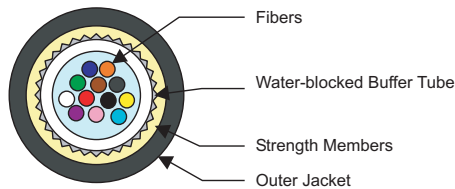
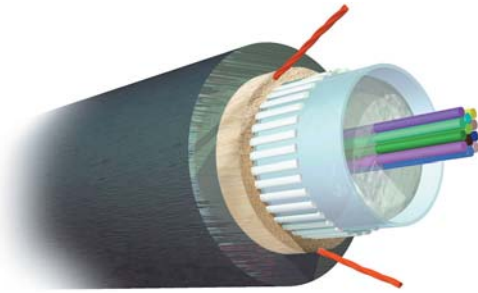

Product Facts

- Suitable for In-building and inter-building backbone cabling (aerial, duct or direct buried)
- Can eliminate the need for a transition point and splicing when entering buildings - go directly from outdoors into building riser or plenum spaces
- TIA color-coded fibers for easy identification
- Water-blocked buffer tube for water penetration protection
- Small diameter single tube construction saves space inside ducts
- Flame-retardant UV-protected jacket for harsh outdoor environment
- All-dielectric construction
- UL and cUL listed OFNR (Riser) and OFNP (Plenum)
- Outer Jacket Color is Black for all Fiber Types

Indoor/Outdoor Single Loose Tube Cables

Single Loose Tube

Fiber Count	Unit Count Units (Fibers/Unit)	Fiber Type	UL/NEC Ratings	Part Number	Weight kg/km (lb/kft)	Diameter mm (in)	Tensile Load N (lbf)		Bending Radius mm (in)									
							Installation	Long Term	Installation	Long Term								
4	1 (4)	Single-mode	Riser	0-1664092-5	71 (48)	8.5 (0.34)	1800 (400)	890 (200)	179 (6.8)	85 (3.4)								
		Multimode 50/125 μm	Riser	2-1664093-5														
		XG Multimode 50/125 μm	Riser	8-1664093-5														
		Multimode 62.5/125 μm	Riser	1-1664094-5														
6	1 (6)	Single-mode	Riser	0-1664095-5	71 (48)	8.5 (0.34)	1800 (400)	890 (200)	179 (6.8)	85 (3.4)								
		Plenum	0-1664233-5	48 (32)							6.6 (0.26)	1335 (300)	400 (90)	99 (3.9)	66 (2.6)			
		Multimode 50/125 μm	Riser	2-1664096-5							71 (48)	8.5 (0.34)	1800 (400)	890 (200)	179 (6.8)	85 (3.4)		
		Plenum	2-1664230-5	48 (32)							6.6 (0.26)	1335 (300)	400 (90)	99 (3.9)	66 (2.6)			
		XG Multimode 50/125 μm	Riser	8-1664096-5							71 (48)	8.5 (0.34)	1800 (400)	890 (200)	179 (6.8)	85 (3.4)		
		Plenum	8-1664230-5	48 (32)							6.6 (0.26)	1335 (300)	400 (90)	99 (3.9)	66 (2.6)			
		Multimode 62.5/125 μm	Riser	1-1664097-5							71 (48)	8.5 (0.34)	1800 (400)	890 (200)	179 (6.8)	85 (3.4)		
		Plenum	1-1664234-5	48 (32)							6.6 (0.26)	1335 (300)	400 (90)	99 (3.9)	66 (2.6)			
		8	1 (8)	Single-mode							Riser	0-1664098-5	71 (48)	8.5 (0.34)	1800 (400)	890 (200)	179 (6.8)	85 (3.4)
				Multimode 50/125 μm							Riser	2-1664099-5						
				XG Multimode 50/125 μm							Riser	8-1664099-5						
				Multimode 62.5/125 μm							Riser	1-1664100-5						
12	1 (12)	Single-mode	Riser	0-1664101-5	71 (48)	8.5 (0.34)	1800 (400)	890 (200)	179 (6.8)	85 (3.4)								
		Plenum	0-1664235-5	48 (32)							6.6 (0.26)	1335 (300)	400 (90)	99 (3.9)	66 (2.6)			
		Multimode 50/125 μm	Riser	2-1664102-5							71 (48)	8.5 (0.34)	1800 (400)	890 (200)	179 (6.8)	85 (3.4)		
		Plenum	2-1664231-5	48 (32)							6.6 (0.26)	1335 (300)	400 (90)	99 (3.9)	66 (2.6)			
		XG Multimode 50/125 μm	Riser	8-1664102-5							71 (48)	8.5 (0.34)	1800 (400)	890 (200)	179 (6.8)	85 (3.4)		
		Plenum	8-1664231-5	48 (32)							6.6 (0.26)	1335 (300)	400 (90)	99 (3.9)	66 (2.6)			
		Multimode 62.5/125 μm	Riser	1-1664103-5							71 (48)	8.5 (0.34)	1800 (400)	890 (200)	179 (6.8)	85 (3.4)		
		Plenum	1-1664236-5	48 (32)							6.6 (0.26)	1335 (300)	400 (90)	99 (3.9)	66 (2.6)			
		1 SM (6)	Hybrid - SM	Riser							4-1664104-5	71 (48)	8.5 (0.34)	1800 (400)	890 (200)	179 (6.8)	85 (3.4)	
		1 MM (6)	62.5/125 μm															

Indoor/Outdoor, 24-144 Fiber

2.1

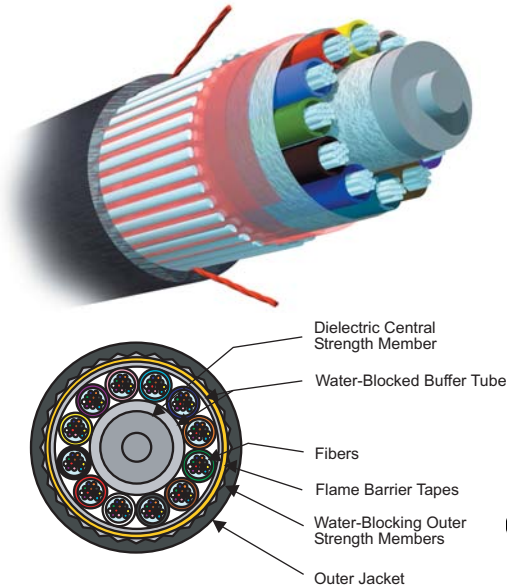

Product Facts

- Suitable for in-building and inter-building backbone cabling (aerial, duct or direct burial)
- Can eliminate the need for a transition point and splicing when entering buildings - go directly from outdoors into building riser or plenum spaces
- Water-blocked buffer tube for water penetration protection
- Flame-retardant UV-protected jacket for harsh outdoor environments
- All-dielectric construction
- Hybrid cables (with single-mode and multimode fibers) are available to provide a built-in migration path for future applications that will require single-mode fibers
- UL and cUL listed OFNR (Riser) and OFNP (Plenum)
- Reverse oscillating lay construction for easy midspan access
- Dry water blocking technology
- TIA color-coded fibers in TIA color-coded tubes for easy identification
- Outer Jacket Color is Black for all Fiber Types

Indoor/Outdoor Stranded Loose Tube Cables

Stranded Loose Tube

Fiber Count Unit (Fibers/Unit)	Fiber Type	UL/NEC Ratings	Part Number	Weight kg/km (lb/kft)	Diameter mm (in)	Tensile Load N (lbf)		Bending Radius mm (in)		
						Installation	Long Term	Installation	Long Term	
24	Single-mode	Riser	0-1664105-5	144 (98)	12.3 (0.48)	2700 (600)	890 (200)	246 (9.7)	123 (4.8)	
		Plenum	0-1664237-5	113 (77)	11.6 (0.46)	2670 (600)	890 (200)	175 (6.9)	117 (4.6)	
	Multimode 50/125 μm	Riser	2-1664106-5	144 (98)	12.3 (0.48)	2700 (600)	890 (200)	246 (9.7)	123 (4.8)	
		Plenum	2-1664232-5	113 (77)	11.6 (0.46)	2670 (600)	890 (200)	175 (6.9)	117 (4.6)	
	XG Multimode 50/125 μm	Riser	8-1664106-5	144 (98)	12.3 (0.48)	2700 (600)	890 (200)	246 (9.7)	123 (4.8)	
		Plenum	8-1664232-5	113 (77)	11.6 (0.46)	2670 (600)	890 (200)	175 (6.9)	117 (4.6)	
	Multimode 62.5/125 μm	Riser	1-1664107-5	144 (98)	12.3 (0.48)	2700 (600)	890 (200)	246 (9.7)	123 (4.8)	
		Plenum	1-1664238-5	113 (77)	11.6 (0.46)	2670 (600)	890 (200)	175 (6.9)	117 (4.6)	
	1 SM (12)	Hybrid - SM 62.5/125 μm	Riser	4-1664123-5	144 (98)	12.3 (0.48)	2700 (600)	890 (200)	246 (9.7)	123 (4.8)
	1 MM (12)	Hybrid - SM XG 50/125 μm	Riser	3-1664411-5	144 (98)	12.3 (0.48)	2700 (600)	890 (200)	246 (9.7)	123 (4.8)
			Plenum	3-1664410-5	113 (77)	11.6 (0.46)	2670 (600)	890 (200)	175 (6.9)	117 (4.6)
	36	Single-mode	Riser	0-1664108-5						
Riser			2-1664109-5							
3 (12)		XG Multimode 50/125 μm	Riser	8-1664109-5	144 (98)	12.3 (0.48)	2700 (600)	890 (200)	246 (9.7)	123 (4.8)
		Multimode 62.5/125 μm	Riser	1-1664110-5						
1 SM (12)		Hybrid - SM	Riser	4-1664124-5						
2 MM (12)		62.5/125 μm	Riser							
48	Single-mode	Riser	0-1664111-5							
		Riser	2-1664112-5							
	4 (12)	XG Multimode 50/125 μm	Riser	8-1664112-5						
		Multimode 62.5/125 μm	Riser	1-1664113-5	144 (98)	12.3 (0.48)	2700 (600)	890 (200)	246 (9.7)	123 (4.8)
	2 SM (12)	Hybrid - SM	Riser	3-1664413-5						
	2 MM (12)	XG 50/125 μm	Plenum	3-1664412-5						
72	Single-mode	Riser	0-1664114-5							
		Riser	2-1664115-5							
	6 (12)	XG Multimode 50/125 μm	Riser	8-1664115-5	168 (110)	13.1 (0.51)	2700 (600)	890 (200)	261 (10.2)	131 (5.1)
		Multimode 62.5/125 μm	Riser	1-1664116-5						
	2 SM (12)	Hybrid - SM	Riser	4-1664125-5						
	4 MM (12)	62.5/125 μm	Riser							
96	Single-mode	Riser	0-1664117-5							
		Riser	2-1664118-5							
	8 (12)	XG Multimode 50/125 μm	Riser	8-1664118-5	277 (190)	17.0 (0.67)	2700 (600)	890 (200)	304 (12.0)	152 (6.0)
		Multimode 62.5/125 μm	Riser	1-1664119-5						
144	Single-mode	Riser	0-1664120-5							
		Riser	2-1664121-5							
	12 (12)	XG Multimode 50/125 μm	Riser	8-1664121-5	305 (210)	18.8 (0.74)	2700 (600)	890 (200)	370 (14.6)	185 (7.3)
		Multimode 62.5/125 μm	Riser	1-1664122-5						

NOTE: Other hybrid fiber count combinations are available - call for more information.

80

Outside Plant (OSP) Dielectric, 4-12 Fiber

2.1

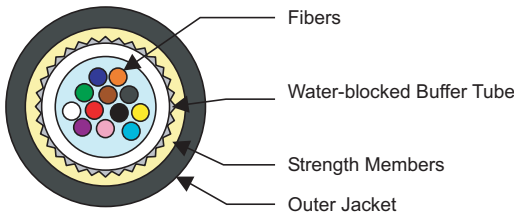
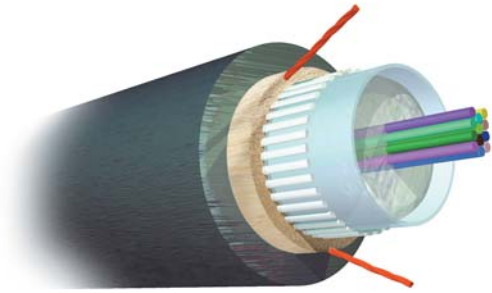

OSP Dielectric Single Loose Tube Cable

Product Facts

- Suitable for inter-building backbone cabling (aerial, duct or direct burial)
- TIA color-coded fibers for easy identification
- Dry water-blocking technology
- Small diameter single tube construction saves space inside ducts
- UV-protected jacket for harsh outdoor environment
- Low friction jacket for ease of pulling through ducts
- All-dielectric construction
- Outer Jacket Color is Black for all Fiber Types

Single Loose Tube

Fiber Count	Unit Count Units (Fibers/Unit)	Fiber Type	Part Number	Weight kg/km (lb/kft)	Diameter mm (in)	Tensile Load N (lbf)		Bending Radius mm (in)	
						Installation	Long Term	Installation	Long Term
4	1 (4)	Single-mode	0-1664211-5	32 (22)	6.0 (0.24)	1000 (220)	890 (200)	100 (3.9)	60 (2.4)
		Multimode 50/125 μm	2-1664212-5						
		XG Multimode 50/125 μm	8-1664212-5						
		Multimode 62.5/125 μm	1-1664213-5						
6	1 (6)	Single-mode	0-1664214-5						
		Multimode 50/125 μm	2-1664215-5						
		XG Multimode 50/125 μm	8-1664215-5						
		Multimode 62.5/125 μm	1-1664216-5						
8	1 (8)	Single-mode	0-1664217-5						
		Multimode 50/125 μm	2-1664218-5						
		XG Multimode 50/125 μm	8-1664218-5						
		Multimode 62.5/125 μm	1-1664219-5						
12	1 (12)	Single-mode	0-1664220-5						
		Multimode 50/125 μm	2-1664221-5						
		XG Multimode 50/125 μm	8-1664221-5						
		Multimode 62.5/125 μm	1-1664222-5						

Outside Plant (OSP) Dielectric, 24-144 Fiber

2.1

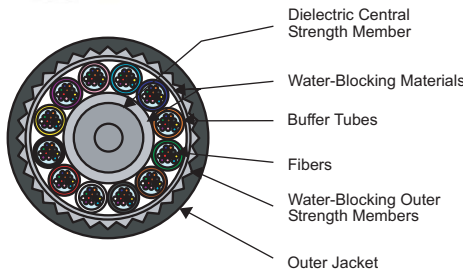
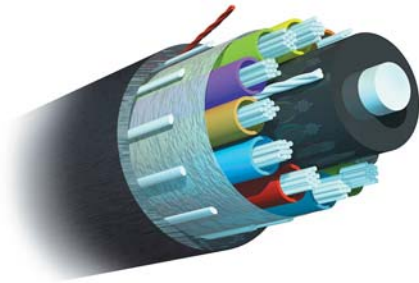

OSP All-Dielectric Stranded Loose Tube Cable

Product Facts

- Suitable for inter-building backbone cabling (aerial, duct or direct buried)
- Dry water-blocking technology
- UV-protected jacket for harsh outdoor environment
- Low friction jacket for ease of pulling through ducts
- All-dielectric construction
- Reverse oscillating lay construction for easy midspan access
- TIA color-coded fibers and buffer tubes for easy identification
- Outer Jacket Color is Black for all Fiber Types

Dielectric Stranded Loose Tube

Fiber Count	Unit Count Units (Fibers/Unit)	Fiber Type	Part Number	Weight kg/km (lb/kft)	Diameter mm (in)	Tensile Load N (lbf)		Bending Radius mm (in)	
						Installation	Long Term	Installation	Long Term
24	2 (12)	Single-mode	0-1664190-5	100 (68)	11.6 (0.46)	2700 (600)	890 (200)	232 (9.2)	116 (4.6)
		Multimode 50/125 μm	2-1664191-5						
		XG Multimode 50/125 μm	8-1664191-5						
		Multimode 62.5/125 μm	1-1664192-5						
	1 SM (12) 1 MM (12)	Hybrid - SM 62.5/125 μm	4-1664208-5						
36	3 (12)	Single-mode	0-1664193-5	100(68)	11.6 (0.46)	2700 (600)	890 (200)	232 (9.2)	116 (4.6)
		Multimode 50/125 μm	2-1664194-5						
		XG Multimode 50/125 μm	8-1664194-5						
		Multimode 62.5/125 μm	1-1664195-5						
	1 SM (12) 2 MM (12)	Hybrid - SM 62.5/125 μm	4-1664209-5						
48	4 (12)	Single-mode	0-1664196-5	100(68)	11.6 (0.46)	2700 (600)	890 (200)	232 (9.2)	116 (4.6)
		Multimode 50/125 μm	2-1664197-5						
		XG Multimode 50/125 μm	8-1664197-5						
		Multimode 62.5/125 μm	1-1664198-5						
	2 SM (12) 4 MM (12)	Hybrid - SM 62.5/125 μm	4-1664210-5						
72	6 (12)	Single-mode	0-1664199-5	130 (88)	12.6 (0.50)	2700 (600)	890 (200)	252 (10.0)	126 (5.0)
		Multimode 50/125 μm	2-1664200-5						
		XG Multimode 50/125 μm	8-1664200-5						
		Multimode 62.5/125 μm	1-1664201-5						
	2 SM (12) 4 MM (12)	Hybrid - SM 62.5/125 μm	4-1664210-5						
96	8 (12)	Single-mode	0-1664202-5	160 (110)	14.4 (0.57)	2700 (600)	890 (200)	288 (11.4)	144 (5.7)
		Multimode 50/125 μm	2-1664203-5						
		XG Multimode 50/125 μm	8-1664203-5						
		Multimode 62.5/125 μm	1-1664204-5						
144	12 (12)	Single-mode	0-1664205-5	250 (170)	18.0 (0.7)	2700 (600)	890 (200)	360 (14.2)	180 (7.1)
		Multimode 50/125 μm	2-1664206-5						
		XG Multimode 50/125 μm	8-1664206-5						
		Multimode 62.5/125 μm	1-1664207-5						

NOTE: Other hybrid fiber count combinations are available - call for more information.

Outside Plant (OSP) Armored, 4-12 Fiber

2.1

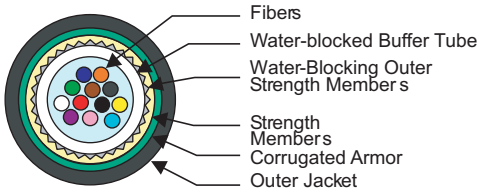
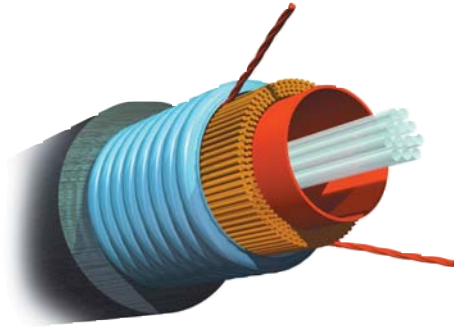

Product Facts

- Suitable for inter-building backbone cabling (aerial, duct or direct buried)
- TIA color-coded fibers for easy identification
- Dry water-blocking technology
- Small diameter single tube construction saves space inside ducts
- UV-protected jacket for harsh outdoor environment
- Low friction jacket for ease of pulling through ducts
- Corrugated steel tape armor for rugged environments and rodent protection
- Outer Jacket Color is Black for all Fiber Types

OSP Armored Single Loose Tube Cable

Armored Single Loose Tube

Fiber Count	Unit Count Units (Fibers/Unit)	Fiber Type	Part Number	Weight kg/km (lb/kft)	Diameter mm (in)	Tensile Load N (lbf)		Bending Radius mm (in)	
						Installation	Long Term	Installation	Long Term
4	1 (4)	Single-mode	0-1664160-5	120 (78)	10.7 (0.42)	2700 (600)	890 (200)	214 (8.4)	107 (4.2)
		Multimode 50/125 μm	2-1664161-5						
		XG Multimode 50/125 μm	8-1664161-5						
		Multimode 62.5/125 μm	1-1664162-5						
6	1 (6)	Single-mode	0-1664163-5						
		Multimode 50/125 μm	2-1664164-5						
		XG Multimode 50/125 μm	8-1664164-5						
		Multimode 62.5/125 μm	1-1664165-5						
8	1 (8)	Single-mode	0-1664166-5						
		Multimode 50/125 μm	2-1664167-5						
		XG Multimode 50/125 μm	8-1664167-5						
		Multimode 62.5/125 μm	1-1664168-5						
12	1 (12)	Single-mode	0-1664169-5						
		Multimode 50/125 μm	2-1664170-5						
		XG Multimode 50/125 μm	8-1664170-5						
		Multimode 62.5/125 μm	1-1664171-5						

Outside Plant (OSP) Armored, 24-144 Fiber

2.1

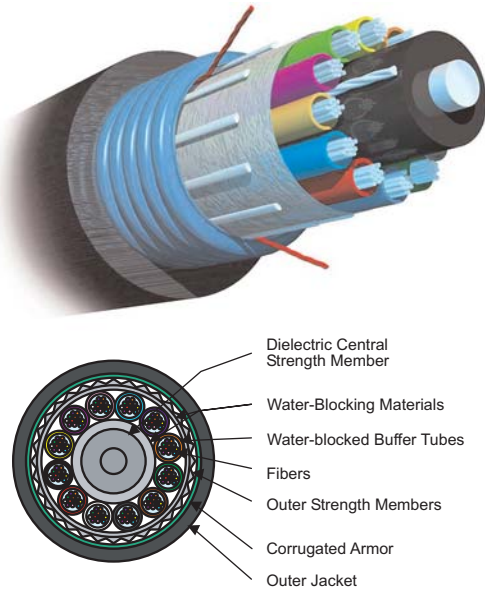

Product Facts

- Suitable for inter-building backbone cabling (aerial, duct or direct burial)
- Dry water-blocking technology
- UV-protected jacket for harsh outdoor environment
- Low friction jacket for ease of pulling through ducts
- Corrugated steel tape for rugged environments and rodent protection
- Reverse oscillating lay construction for easy midspan access
- Hybrid cables (with single-mode and multimode fibers) are available to provide a built-in migration path for future applications that will require single-mode fibers
- TIA color-coded fibers and buffer tubes for easy identification
- Outer Jacket Color is Black for all Fiber Types

OSP Armored Stranded Loose Tube Cable

Armored Stranded Loose Tube

Fiber Count	Unit Count Units (Fibers/Unit)	Fiber Type	Part Number	Weight kg/km (lb/kft)	Diameter mm (in)	Tensile Load N (lbf)		Bending Radius mm (in)	
						Installation	Long Term	Installation	Long Term
24	2 (12)	Single-mode	0-1664172-5	170 (120)	13.4 (0.53)	2700 (600)	890 (200)	268 (10.6)	134 (5.3)
		Multimode 50/125 μm	2-1664173-5						
		XG Multimode 50/125 μm	8-1664173-5						
		Multimode 62.5/125 μm	1-1664174-5						
36	3 (12)	Single-mode	0-1664175-5	160 (110)	13.4 (0.53)	2700 (600)	890 (200)	268 (10.6)	134 (5.3)
		Multimode 50/125 μm	2-1664176-5						
		XG Multimode 50/125 μm	8-1664176-5						
		Multimode 62.5/125 μm	1-1664177-5						
48	4 (12)	Single-mode	0-1664178-5	160 (110)	13.4 (0.53)	2700 (600)	890 (200)	268 (10.6)	134 (5.3)
		Multimode 50/125 μm	2-1664179-5						
		XG Multimode 50/125 μm	8-1664179-5						
		Multimode 62.5/125 μm	1-1664180-5						
72	6 (12)	Single-mode	0-1664181-5	200 (140)	14.2 (0.56)	2700 (600)	890 (200)	284 (11.2)	142 (5.6)
		Multimode 50/125 μm	2-1664182-5						
		XG Multimode 50/125 μm	8-1664182-5						
		Multimode 62.5/125 μm	1-1664183-5						
96	6 (12)	Single-mode	0-1664184-5	230 (160)	16.0 (0.63)	2700 (600)	890 (200)	320 (12.6)	160 (6.3)
		Multimode 50/125 μm	2-1664185-5						
		XG Multimode 50/125 μm	8-1664185-5						
		Multimode 62.5/125 μm	1-1664186-5						
144	12 (12)	Single-mode	0-1664187-5	350 (240)	20.0 (0.78)	2700 (600)	890 (200)	392 (15.4)	196 (7.7)
		Multimode 50/125 μm	2-1664188-5						
		XG Multimode 50/125 μm	8-1664188-5						
		Multimode 62.5/125 μm	1-1664189-5						

NOTE: Hybrid fiber count combinations are available. Call for more information.

Interlocking Jacketed Aluminum Armored Cable



Product Facts

- Robust construction provides extra protection for optical fibers
- Interlocking armor enhances flexibility
- Lightweight aluminum armor simplifies handling
- Installer-friendly plenum rated over-jacketing makes cable pulls easier
- Over-jacketing color:
 - Single-mode: Yellow
 - 50/125 and 62.5/125 μm: Orange
 - XG 50/125 μm: Aqua
 - Hybrid: Orange
- Pending local codes, may eliminate the need for innerduct
- All common fiber types available
- Hybrid single and multimode cables maintain flexibility and support future needs
- OFNP rated
- TIA Color Coded fibers
- Strippable 900 μm tight buffer coating allows for easy connectorization
- Indoor/Outdoor and specialty versions available

2.1

Interlocking Armored Cable

Fiber Count	Unit Count Units (Fibers/Unit)	Fiber Type	Cable Type	UL/NEC Ratings	Part Number	Weight kg/km (lb/kft)	Diameter mm (in)	Tensile Load N (lbf)		Bending Radius mm (in)	
								Installation	Long Term	Installation	Long Term
6	1 (6)	Single-mode	Distribution	Plenum	4-1777121-7	117 (79)	12.8 (.505)	445 (100)	133 (30)	192 (7.6)	128 (5.1)
		Single-mode	Distribution	Plenum	4-1777117-7						
12	1 (12)	Multimode 50/125 μm	Distribution	Plenum	2-1777117-7	87 (129)	13.4 (0.527)	445 (100)	133 (30)	201 (7.9)	134 (5.3)
		XG Multimode 50/125 μm	Distribution	Plenum	3-1777117-7						
		Multimode 62.5/125 μm	Distribution	Plenum	1-1777117-7						
24	2 (12)	Single-mode	Distribution	Plenum	4-1777122-7	240 (161)	18.8 (0.739)	667 (150)	200 (45)	285 (11.2)	190 (7.5)
		Multimode 50/125 μm	Distribution	Plenum	2-1777122-7						
		XG Multimode 50/125 μm	Distribution	Plenum	3-1777122-7						
		Multimode 62.5/125 μm	Distribution	Plenum	1-1777122-7						
	1 SM (12)	Hybrid SM/XG 50 μm	Distribution	Plenum	5-1777122-7						
1 MM (12)	Hybrid SM/50 μm	Distribution	Plenum	6-1777122-7							
48	4 (12)	Multimode 50/125 μm	Distribution	Plenum	2-1777123-7	408 (274)	23.4 (.921)	667 (150)	200 (45)	351 (13.8)	234 (9.2)
		XG Multimode 50/125 μm	Distribution	Plenum	3-1777123-7						
		Hybrid SM/XG 50 μm	Distribution	Plenum	5-1777123-7						
72	6 (12)	Hybrid SM/50 μm	Distribution	Plenum	6-1777123-7	583 (392)	25.4 (1.00)	1334 (300)	400 (90)	381 (15)	254 (10)
		Multimode 50/125 μm	Distribution	Plenum	2-1777124-7						
144	12 (12)	XG Multimode 50/125 μm	Distribution	Plenum	3-1777124-7	159 (350)	24.69 (.972)	2669 (600)	890 (200)	37.1 (14.6)	24.6 (9.7)
		Single-mode	Indoor/Outdoor	Plenum	4-1777139-7						

Horizontal, 2-4 Fiber

2.1

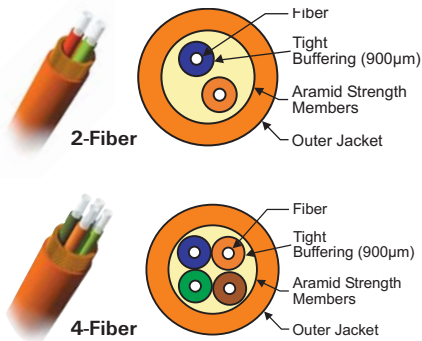

Product Facts

- Suitable for direct termination with epoxy/polish, LightCrimp, LightCrimp PLUS and MT-RJ jacks
- Blue, green, red and yellow Dual and Quad multimode cables for MT-RJ SECURE Networks or network segregation
- Aramid yarn reinforcement
- UL and cUL listed OFNR (Riser) and OFNP (Plenum)

2-Fiber (Dual)

Fiber Count	Unit Count Units (Fibers/Unit)	Fiber Type	UL/NEC Ratings	Jacket Color	Part Number	Weight kg/km (lb/kft)	Diameter mm (in)	Tensile Load N (lbf)		Bending Radius mm (in)	
								Installation	Long Term	Installation	Long Term
2	1(2)	Single-mode	Riser	Yellow	0-1664024-6	19 (13)	4.8 (0.19)	220 (50)	55 (12.5)	95 (3.8)	48 (1.9)
			Plenum	Yellow	0-1664025-6	23 (16)					
			Riser	Orange	2-1664026-1	19 (13)					
				Blue	2-1664026-0	19 (13)					
				Green	2-1664026-2	19 (13)					
				Red	2-1664026-4	19 (13)					
		Multimode 50/125 µm	Yellow	2-1664026-6	19 (13)						
			Orange	2-1664027-1	23 (16)						
			Blue	2-1664027-0	23 (16)						
			Plenum	Green	2-1664027-2	23 (16)					
				Red	2-1664027-4	23 (16)					
			XG Multimode 50/125 µm	Riser	Aqua	8-1664026-9					
		Plenum		Aqua	8-1664027-9	23 (16)					
				Orange	1-1664028-1	19 (13)					
		Riser		Blue	1-1664028-0	19 (13)					
				Green	1-1664028-2	19 (13)					
				Red	1-1664028-4	19 (13)					
				Multimode 62.5/125 µm	Yellow	1-1664028-6					
		Orange			1-1664029-1	23 (16)					
		Blue			1-1664029-0	23 (16)					
Plenum	Green	1-1664029-2			23 (16)						
	Red	1-1664029-4			23 (16)						
Yellow	1-1664029-6	23 (16)									

4-Fiber (Quad)

4	1(4)	Single-mode	Riser	Yellow	0-1664030-6	21 (14)	4.8 (0.19)	220 (50)	55 (12.5)	95 (3.8)	48 (1.9)
			Plenum	Yellow	0-1664031-6	25 (17)					
			Riser	Orange	2-1664032-1	21 (14)					
				Blue	2-1664032-0	21 (14)					
				Green	2-1664032-2	21 (14)					
				Red	2-1664032-4	21 (14)					
		Multimode 50/125 µm	Yellow	2-1664032-6	21 (14)						
			Orange	2-1664033-1	25 (17)						
			Blue	2-1664033-0	25 (17)						
			Plenum	Green	2-1664033-2	25 (17)					
				Red	2-1664033-4	25 (17)					
			Yellow	2-1664033-6	25 (17)						
		XG Multimode 50/125 µm	Riser	Aqua	8-1664032-9	21 (14)					
			Plenum	Aqua	8-1664033-9	25 (17)					
				Orange	1-1664034-1	21 (14)					
			Riser	Blue	1-1664034-0	21 (14)					
				Green	1-1664034-2	21 (14)					
				Red	1-1664034-4	21 (14)					
				Multimode 62.5/125 µm	Yellow	1-1664034-6					
			Orange		1-1664035-1	25 (17)					
Blue	1-1664035-0		25 (17)								
Plenum	Green		1-1664035-2		25 (17)						
	Red		1-1664035-4		25 (17)						
Yellow	1-1664035-6		25 (17)								

86

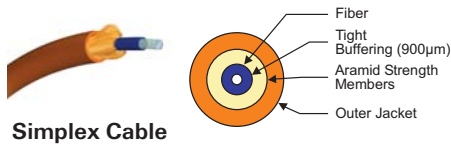

Simplex Cable

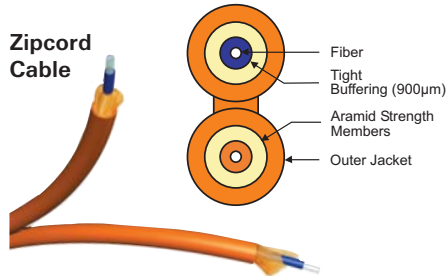

Zipcord Cable

Product Facts

- Suitable for pigtails, patch cords and internal equipment connections
- Aramid yarn reinforcement
- UL and cUL listed OFNR (Riser) and OFNP (Plenum)
- Outer Jacket Color: Single-mode: Yellow
50/125 and 62.5/125 µm: Orange
XG 50/125 µm: Aqua

2.1

Simplex (2.0mm)

Fiber Count	Unit Count Units (Fibers/Unit)	Fiber Type	UL/NEC Ratings	Part Number	Weight kg/km (lb/kft)	Diameter mm (in)	Tensile Load N (lbf)		Bending Radius mm (in)	
							Installation	Long Term	Installation	Long Term
1	1 (1)	Single-mode	Riser	0-1664006-6	5 (3)	2.0 (0.08)	220 (50)	55 (12.5)	40 (1.6)	20 (0.8)
			Plenum	0-1664007-6	6 (4)					
		Multimode 50/125 µm	Riser	2-1664008-1	5 (3)					
			Plenum	2-1664009-1	6 (4)					
		XG Multimode 50/125 µm	Riser	8-1664008-9	5 (3)					
			Plenum	8-1664009-9	6 (4)					
Multimode 62.5/125 µm	Riser	1-1664010-1	5 (3)							
	Plenum	1-1664011-1	6 (4)							

Simplex (2.9mm)

1	1 (1)	Single-mode	Riser	0-1664000-6	8 (5)	2.9 (0.11)	220 (50)	55 (12.5)	58 (2.8)	29 (1.1)
			Plenum	0-1664001-6	9 (6)					
		Multimode 50/125 µm	Riser	2-1664002-1	8 (5)					
			Plenum	2-1664003-1	9 (6)					
		XG Multimode 50/125 µm	Riser	8-1664002-9	8 (5)					
			Plenum	8-1664003-9	9 (6)					
Multimode 62.5/125 µm	Riser	1-1664004-1	8 (5)							
	Plenum	1-1664005-1	9 (6)							

Zipcord (2.0mm)

2	2 (1)	Single-mode	Riser	0-1664018-6	6 (4)	2.0 x 4.0 (0.08 x 0.16)	220 (50)	55 (12.5)	40 (2.2)	20 (0.8)
			Plenum	0-1664019-6	8 (5)					
		Multimode 50/125 µm	Riser	2-1664020-1	6 (4)					
			Plenum	2-1664021-1	8 (5)					
		XG Multimode 50/125 µm	Riser	8-1664020-9	6 (4)					
			Plenum	8-1664021-9	8 (5)					
Multimode 62.5/125 µm	Riser	1-1664022-1	6 (4)							
	Plenum	1-1664023-1	8 (5)							

Zipcord (2.9mm)

2	2 (1)	Single-mode	Riser	0-1664012-6	15 (10)	2.9 x 5.8 (0.11 x 0.22)	220 (50)	55 (12.5)	58 (2.2)	29 (1.1)
			Plenum	0-1664013-6	18 (12)					
		Multimode 50/125 µm	Riser	2-1664014-1	15 (10)					
			Plenum	2-1664015-1	18 (12)					
		XG Multimode 50/125 µm	Riser	8-1664014-9	15 (10)					
			Plenum	8-1664015-9	18 (12)					
Multimode 62.5/125 µm	Riser	1-1664016-1	15 (10)							
	Plenum	1-1664017-1	18 (12)							

Notes

2.1

CONNECTORS, MECHANICAL SPLICES, COUPLERS, & ADAPTERS

MT-RJ Jacks and Accessories	92-94
MT-RJ Outlet Jacks	92
MT-RJ Patch Panel Jacks	93
MT-RJ Accessories	94
LightCrimp PLUS Connectors	95
LC	95
SC	95
ST	95
LightCrimp Connectors	96
SC	96
ST	96
Epoxy/Polish Connectors	97-99
LC	97
Simplex SC	98
Duplex SC	98
ST	99
CORELINK Mechanical Splices	99
Couplers and Adapters	100
Multimedia Inserts and Modules	101

2.2

Chapter Summary

- Tyco Electronics offers a broad product line of connector types (MT-RJ, LC, SC, ST, etc.), termination technologies (no-epoxy/no-polish, no-epoxy/polish and epoxy/polish) and related products. If you have product needs beyond those listed in this catalog, please call the Tyco Electronics Product Information Center at 1-800-522-6752.

2.2



89

Connector Information

2.2

Optical Fiber Cable Assembly Performance Details

Test Description	FOTP*	Requirement
Visual and Mechanical Inspection:	MT-RJ –	TIA/EIA-604-12 (FOCIS 12)
	SC –	TIA/EIA-604-3 (FOCIS 3)
	ST –	TIA/EIA-604-2 (FOCIS 2)
	LC –	TIA/EIA-604-10 (FOCIS 10)
Attenuation	34	≤ 0.75 dB
Return Loss	107	≤ -20 dB
Low Temperature (0° C for 4 days)	188	≤ 0.3 dB change
Temperature Life (55° C for 14 days)	7	≤ 0.3 dB change
Humidity (90 to 95% @ 40° C for 4 days)	5	≤ 0.3 dB change
Impact (8 drops from 1.8 m)	2	≤ 0.75 dB IL, ≤ -20 dB RL
Durability (500 cycles)	21	≤ 0.75 dB IL, ≤ -20 dB RL
Cable Retention (0° and 90°)	6	≤ 0.75 dB IL, ≤ -20 dB RL
Flex (100 cycles)	1	≤ 0.75 dB IL, ≤ -20 dB RL
Twist (10 cycles)	36	≤ 0.75 dB IL, ≤ -20 dB RL

*Note: FOTP = Fiber Optic Test Procedure per TIA/EIA-455-XX Series
FOCIS = Fiber Optic Connector Interchangeability Standard

Optical Fiber Connector Termination Comparison Chart

		MT-RJ Jacks	LightCrimp PLUS	LightCrimp	Epoxy/Polish
Connector Types	50/125 μm Multimode	Outlet, Patch Panel	LC, SC, ST	SC, ST	LC, SC, ST
	XG (850 nm LO 50 μm) Multimode	Outlet, Patch Panel	LC, SC	SC, ST	LC, SC, ST
	62.5/125 μm Multimode	Outlet, Patch Panel	LC, SC, ST	SC, ST	LC, SC, ST
	Single-mode	Pigtail Jacks	LC, SC	ST	LC, SC, ST
Termination Technology	Epoxy Required	NO	NO	NO	YES
	Polish Required	NO	NO	YES	YES
	Crimp Required	NO	YES	YES	YES
Setup Time	Each Location	< 3 Minutes	< 2 Minutes	< 10 Minutes	< 12 Minutes
Installation Time	Each Fiber	~ 1 Minute	~ 1 Minute	< 6 Minutes	7 – 25 Minutes
Connector Cost	Relative	Higher	Higher	Moderate	Lower
Installation Labor Cost	Relative	Lower	Lower	Moderate	Higher
Tool Kit Cost	Relative	Lower	Lower	Moderate	Higher
Skill Level	Relative	Lower	Lower	Moderate	Higher
Training Time	Relative	Short	Short	Moderate	High

NOTE: Entries for time and cost are estimates and relative comparisons. Actual results will vary depending on experience level and conditions at time of termination.

Jack, Plug and Insert Compatibility List

		Part Number	SL Series	MT-RJ and	LightCrimp PLUS			LightCrimp		Epoxy/Polish		
			MT-RJ and MT-RJ SECURE Outlet Jacks	MT-RJ SECURE Patch Panel Jacks	LC	SC	ST	SC	ST	LC	SC	ST
SL Series Modules (Chapter 3)	2-Port	1116409	X	-	-	-	-	-	-	-	-	-
		1116406	X	-	-	-	-	-	-	-	-	-
	3-Port	1116408	X	-	-	-	-	-	-	-	-	-
	Duplex SC, Single-mode	1375306	-	-	-	X	-	X	-	-	X	-
	Duplex SC, Multimode	1375123	-	-	-	X	-	X	-	-	X	-
SL Series Inserts (Chapter 2.2)	Duplex SC to ST, Multimode	1375241	-	-	-	X	X	X	X	-	X	X
	ST, Multimode	1339123	-	-	-	-	X	-	X	-	X	X
	ST, Single-mode	1479181	-	-	-	-	X	-	X	-	-	X
	LC Duplex, Multimode	1435735	-	-	-	X	-	-	-	-	X	-
	LC Duplex, Single-mode	1435799	-	-	-	X	-	-	-	-	X	-
HIDEAWAY and HIDEOUT Accessories (Chapter 3)	MT-RJ SL Series Housing, Single-mode/Multimode	1374416	*X	X	-	-	-	-	-	-	-	-
	SC Duplex, Multimode	5504640	-	-	-	X	-	X	-	-	X	-
	SC Duplex to Dual ST, Multimode	5504663	-	-	-	X	X	X	X	-	X	X
	Dual ST, Multimode	504662	-	-	-	-	X	-	X	-	-	X
	MT-RJ Parallel Dress Clips, 1-Port	1374206	X**	X	-	-	-	-	-	-	-	-
Surface Mount Outlet Inserts (Chapter 3)	MT-RJ Parallel Dress Clips, 2-Port	1374205	X**	X	-	-	-	-	-	-	-	-
	1-Port	1116098	X	-	-	-	-	-	-	-	-	-
	2-Port	557775	X	-	-	-	X	-	X	-	-	X
Universal Office Box Inserts (Chapter 3)	2-Port	557350	-	-	-	-	-	-	-	-	-	-
	ST, Multimode	1479495	-	-	-	-	X	-	X	-	-	X
ACO Dual-Port Faceplate Kit (Chapter 3)	Dual - SC Duplex, Multimode	503662	-	-	-	X	-	X	-	-	X	-
	Quad - ST, Multimode	502604	-	-	-	-	X	-	X	-	-	X
	Dual - ST, Multimode	502604	-	-	-	-	X	-	X	-	-	X
AFWM Flush Faceplates (Chapter 3)	Dual - SC Duplex, Multimode	557322	-	-	-	X	-	X	-	-	X	-
	Quad - ST, Multimode	557474	-	-	-	-	X	-	X	-	-	X
Optical Fiber MUO Modules (Chapter 3)	MT-RJ Jack, Single-mode/Multimode	1375347	X**	X	-	-	-	-	-	-	-	-
	SC Duplex, Multimode	406818	-	-	-	X	-	X	-	-	X	-
	SC Duplex to Dual ST, Multimode	406819	-	-	-	X	X	X	X	-	X	X
	Dual ST, Multimode	406820	-	-	-	-	X	-	X	-	-	X

*Note: SL Series MT-RJ Outlet Jacks come with SL Series MT-RJ Housing.

**Note: SL Series Housing is not used when using SL Series MT-RJ Outlet Jacks with MT-RJ Parallel Dress Clips or MT-RJ Jack MUO Modules.

2.2

MT-RJ Outlet Jacks

2.2

**MT-RJ Outlet Jacks
(No-epoxy/No-polish)**

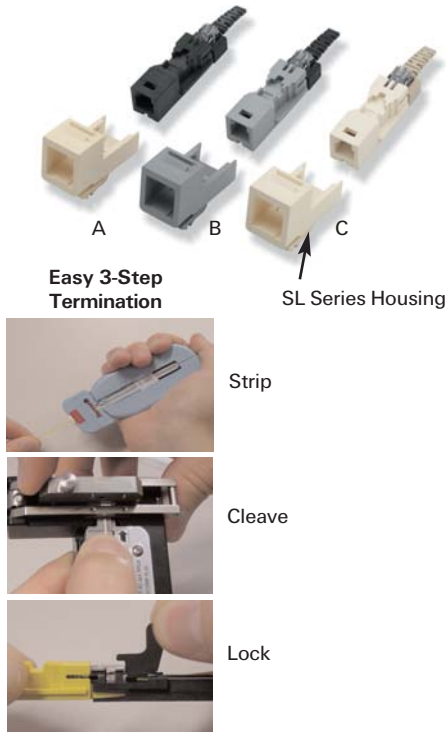

Product Facts

- Outlet jacks terminate two 900 μm tight-buffered fibers
 - No epoxy, no polishing, no crimping
 - Two fibers in one ferrule
 - Re-terminatable - improves yield
 - Tunable
 - No bench tool required
- Each part number includes:
 - One (1) outlet jack
 - Actuation tool
 - Bend-limiting boot
 - SL Series Housing
- Match fiber type of cable to fiber type of MT-RJ Jack
- Jack design eliminates need for MT-RJ Coupler
- Small form factor design is half the size of SC duplex
- Included SL Series housing allows use in any faceplate or outlet that accepts SL Series Jacks
- MT-RJ Cable Assemblies in Chapter 2.3
- For MT-RJ SECURE jacks, see Chapter 4

Fiber Type	Jack Color	Figure	Part Number	
50/125 μm	Used with 900μm Tight-buffered Fibers	Black	A	6278414-X
XG 850nm LO 50/125 μm	Used with 900μm Tight-buffered Fibers	Gray	B	1-6278414-2
62.5/125 μm	Used with 900μm Tight-buffered Fibers	Beige	C	6278415-X

X denotes housing color: -1 = Almond, -2 = Black, -3 = White, -4 = Gray, -5 = Orange, -6 = Blue, -7 = Red, -8 = Yellow, -9 = Green, 1--0 = Violet, 1--1 = Electrical Ivory

MT-RJ Patch Panel Jacks (No-epoxy/No-polish)

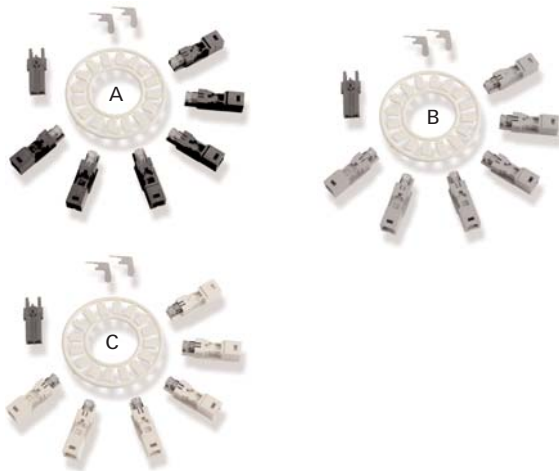

Easy 3-Step Termination



Strip

Cleave

Lock

Product Facts

- Patch panel jacks terminate either two 900 μm tight-buffered fibers or two 250 μm coated fibers (select appropriate part number):
 - No epoxy, no polishing, no crimping
 - Two (2) fibers in one ferrule
 - Re-terminatable – improves yield
 - Tunable
 - No bench tool required
- Each part number includes:
 - Six (6) patch panel jacks
 - Two (2) actuation tools
 - Fiber guide
 - Icon wheel
- Jack design eliminates need for MT-RJ Coupler
- Match fiber type of cable to fiber type of MT-RJ Jack
- Small form factor design is half the size of SC duplex
- Six (6) patch panel jacks fit in the MT-RJ Snap-in Adapter Plate (see Chapter 2.5)
- SL Series Housings and bend-limiting boots sold separately (see this Chapter)
- MT-RJ Cable Assemblies in Chapter 2.3
- Single-mode MT-RJ pigtail jacks in Chapter 2.3
- For MT-RJ SECURE jacks, see Chapter 4

2.2

Fiber Type	Jack Color	Figure	Part Number	
			250 μm Coated Fiber	900 μm Tight-buffered Fiber
50/125 μm	Black	A	6278303-1	6588880-1
XG 850 nm LO 50/125 μm	Gray	B	6278303-4	6588880-3
62.5/125 μm	Beige	C	6278303-2	6588880-2

MT-RJ Patch Panel Jack Accessories

2.2

MT-RJ Bend-Limiting Boots

PART NUMBER 6374208-X



X denotes color: -4 = Black, -5 = Beige, -6 = Blue

Product Facts

- Compatible with all MT-RJ Jacks
- Comes in a package of six
- Protects fiber transition at back of MT-RJ Jack

MT-RJ Parallel Dress Clips



Product Facts

- 1-Port clip holds one MT-RJ Jack (sold separately)
- 2-Port clip holds two MT-RJ Jacks (sold separately)
- Clips allow use of MT-RJ Jacks in faceplates and outlets that hold flanged optical fiber adapters
- MT-RJ Outlet Jacks (this Chapter) not included
- For MT-RJ SECURE jacks, see Chapter 4
- Used with HIDEAWAY and HIDEOUT outlets (Chapter 3)

Description		Part Number
1-Port	Package of 6	1374206-1
2-Port	Package of 3	1374205-1

**LightCrimp PLUS Connectors
(No-epoxy/No-polish)**

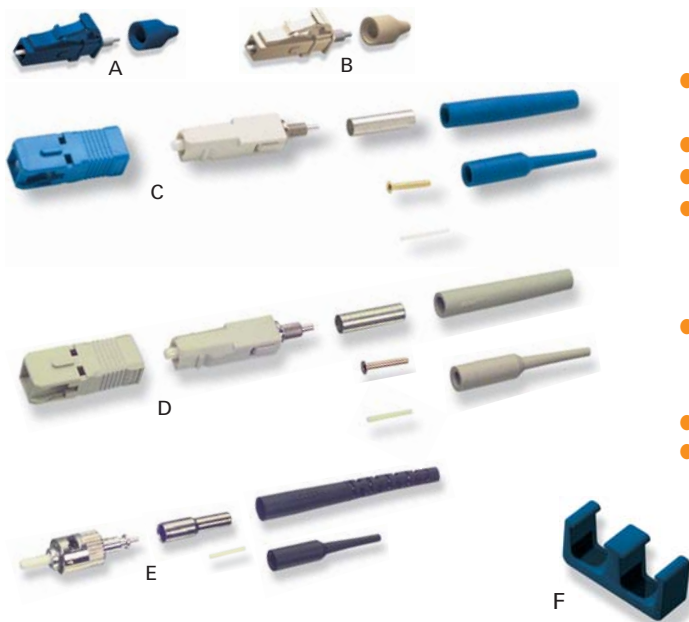

Product Facts

- Easy installation:
 - No epoxy, no polishing
 - No bench tool required
 - Strip, cleave, and crimp
- Match fiber type of cable to fiber type of LightCrimp PLUS
- Mates with standard couplers, adapters, and adapter plates
- LC small form factor design is half the size of SC
- Select appropriate part number for termination to:
 - 900 μm tight-buffered fiber or 250 μm coated fiber
 - 1.6 – 2.0 mm jacketed fiber
 - 3 mm jacketed cable
- LC connector clip turns simplex connectors into duplex connectors and allows for polarity correction after termination.
- Termination tool kits in Chapter 2.7
- For LightCrimp PLUS LC SECURE connectors, see Chapter 4

2.2

Connector Type	Fiber Type	Housing Color	Boot Color	Used With	Figure	Part Number
Simplex LC	Single-mode	Blue	Blue	900 μm & 250 μm Fibers	A	6754482-1
	50/125 μm	Beige	Black	900 μm & 250 μm Fibers	–	6754483-2
	XG (850 nm LO 50/125 μm)	Beige	Aqua	900 μm & 250 μm Fibers	–	6754483-4
	62.5/125 μm	Beige	Beige	900 μm & 250 μm Fibers	B	6754483-1
	Single-mode	Blue	Blue	1.6 - 2.0 mm Cable	–	1918626-1
	50/125 μm	Beige	Black	1.6 - 2.0 mm Cable	–	1918627-2
Duplex LC	XG (850 nm LO 50/125 μm)	Beige	Aqua	1.6 - 2.0 mm Cable	–	1918627-3
	62.5/125 μm	Beige	Beige	1.6 - 2.0 mm Cable	–	1918627-1
	Single-mode	Blue	Blue	900 μm & 250 μm Fibers	–	6754484-1
	50/125 μm	Beige	Black	900 μm & 250 μm Fibers	–	6754485-2
	XG (850 nm LO 50/125 μm)	Beige	Aqua	900 μm & 250 μm Fibers	–	6754485-4
	62.5/125 μm	Beige	Beige	900 μm & 250 μm Fibers	–	6754485-1
Simplex SC	Single-mode	Blue	Blue	900 μm & 250 μm Fibers, 3mm Cable	C	6693276-1
	50/125 μm	Beige	Black	900 μm & 250 μm Fibers, 3 mm Cable	–	6278079-2
	XG (850 nm LO 50/125 μm)	Beige	Aqua	900 μm & 250 μm Fibers, 3 mm Cable	–	6588291-2
	62.5/125 μm	Beige	Beige	900 μm & 250 μm Fibers, 3 mm Cable	–	5492643-1
Duplex SC	Single-mode	Blue	Blue	900 μm & 250 μm Fibers, 3mm Cable	–	6693278-1
	50/125 μm	Beige	Black	900 μm & 250 μm Fibers, 3 mm Cable	–	6278080-2
	XG (850 nm LO 50/125 μm)	Beige	Aqua	900 μm & 250 μm Fibers, 3 mm Cable	–	6588292-2
	62.5/125 μm	Beige	Beige	900 μm & 250 μm Fibers, 3 mm Cable	–	6278009-1
ST	50/125 μm	Metallic	Black	900 μm & 250 μm Fibers, 3 mm Cable	E	6278082-1
	62.5/125 μm	Metallic	Beige	900 μm & 250 μm Fibers, 3 mm Cable	E	5492642-2
Duplex LC Clip		Black	–	package of 6 clips (for use with Simplex kits)	F	1754371-2
Duplex SC Clip (use 2)		Black	–	2 pieces make 1 clip (for use with Simplex kits)	–	6348522-1

95

LightCrimp Connectors

2.2

**LightCrimp Connectors
(No-epoxy/Polish)**

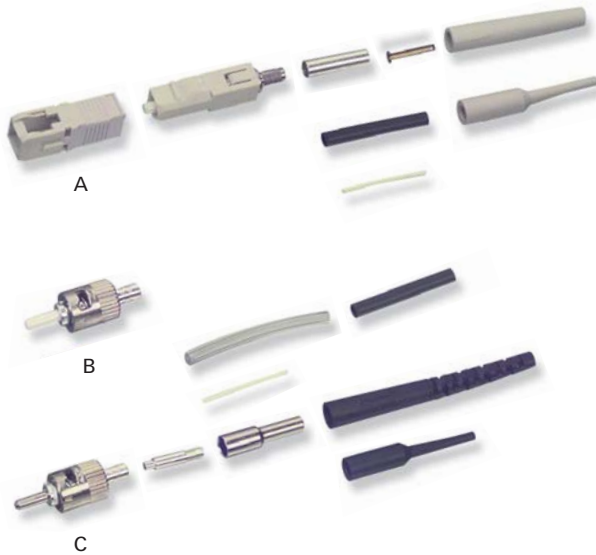

Product Facts

- No epoxy needed
- Easy installation: strip, crimp, cleave, and polish
- Each connector kit comes with accessories needed to terminate to 250 μm fiber, 900 μm tight-buffered fiber, and 3 mm cables
- Duplex part numbers contain two connectors
- Multimode connectors are suitable for use with 50/125 μm, XG (850 nm LO 50/125 μm) and 62.5/125 μm fibers
- Mates with all standards compliant couplers, adapters, and adapter plates

Description			Figure	Part Number
Simplex SC	Multimode	Ceramic Ferrule	A	5503692-1
Duplex SC	Multimode	Ceramic Ferrule	-	5503693-1
	Single-mode	Ceramic Ferrule	B	5504000-1
ST	Multimode	Stainless Steel Ferrule	C	5504034-1
		Ceramic Ferrule	B	5504001-1

LC Connectors (Epoxy/Polish)

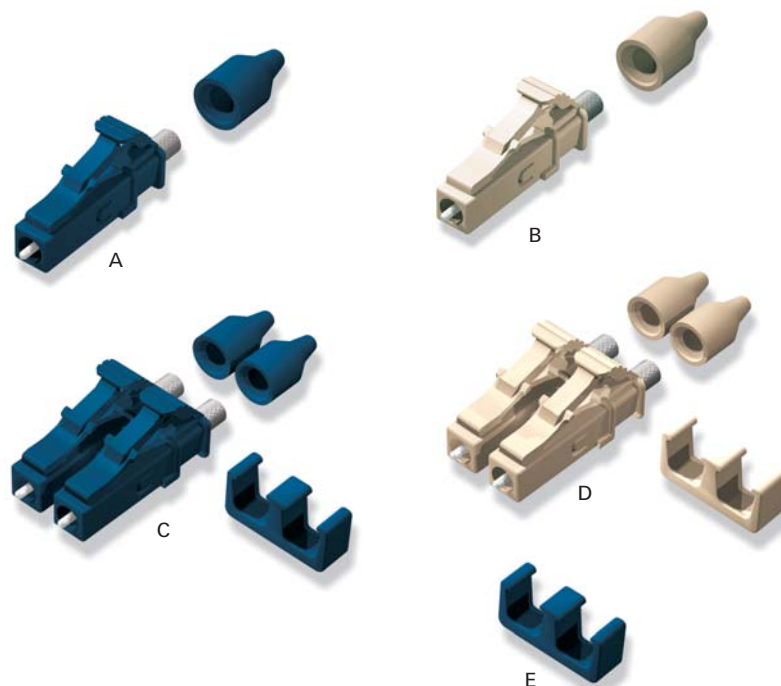

Product Facts

- LC small form factor design is half the size of SC
- Each connector kit comes with accessories needed to terminate to 250 μm fiber, 900 μm tight-buffered fiber, 900 μm easy-strip, buffer tube splitter kits, 2.0 mm or 3 mm cable (select appropriate part number)
- Duplex kits include two simplex connectors and one duplex clip
- Suitable for use with heat-cured or anaerobic (quick cure) adhesive
 - See Instruction Sheet for recommended anaerobic adhesive
- Multimode connectors are suitable for use with 50/125 μm , XG (850 nm LO 50/125 μm), and 62.5/125 μm fibers.
- Mates with standard couplers, adapters, and adapter plates
- Single-mode connectors are tunable.
- For LC SECURE connectors, see Chapter 4

2.2

LC Epoxy/Polish Connectors

Description	Fiber Type	Housing Color	Boot Color	Used With	Figure	Part Number
Simplex	Single-mode	Blue	Blue	900 μm & 250 μm Fibers	A	1918384-1
				1.6 – 2.0 mm Cable	–	1918266-1
				3.0 mm Cable	–	1918374-1
	XG 850nm LO 50/125 μm	Beige	Aqua	900 μm & 250 μm Fibers	–	1918385-3
				1.6 – 2.0 mm Cable	–	1918267-3
				3.0 mm Cable	–	1918375-3
	50/125 μm	Beige	Black	900 μm & 250 μm Fibers	–	1918385-4
				1.6 – 2.0 mm Cable	–	1918267-4
				3.0 mm Cable	–	1918375-4
	62.5/125 μm	Beige	Beige	900 μm & 250 μm Fibers	B	1918385-1
				1.6 – 2.0 mm Cable	–	1918267-1
				3.0 mm Cable	–	1918375-1
Duplex	Single-mode	Blue	Blue	900 μm & 250 μm Fibers	C	1918387-1
				1.6 – 2.0 mm Cable	–	1918372-1
				3.0 mm Cable	–	1918376-1
	XG 850nm LO 50/125 μm	Beige	Aqua	900 μm & 250 μm Fibers	–	1918388-3
				1.6 – 2.0 mm Cable	–	1918373-3
				3.0 mm Cable	–	1918377-3
	50/125 μm	Beige	Black	900 μm & 250 μm Fibers	–	1918388-4
				1.6 – 2.0 mm Cable	–	1918373-4
				3.0 mm Cable	–	1918377-4
	62.5/125 μm	Beige	Beige	900 μm & 250 μm Fibers	D	1918388-1
				1.6 – 2.0 mm Cable	–	1918373-1
				3.0 mm Cable	–	1918377-1
Duplex Clip	(package of 6)	Black	–	(for use with Simplex kits)	E	1754371-2

97

Epoxy/Polish Connectors

2.2

SC Connectors (Epoxy/Polish)

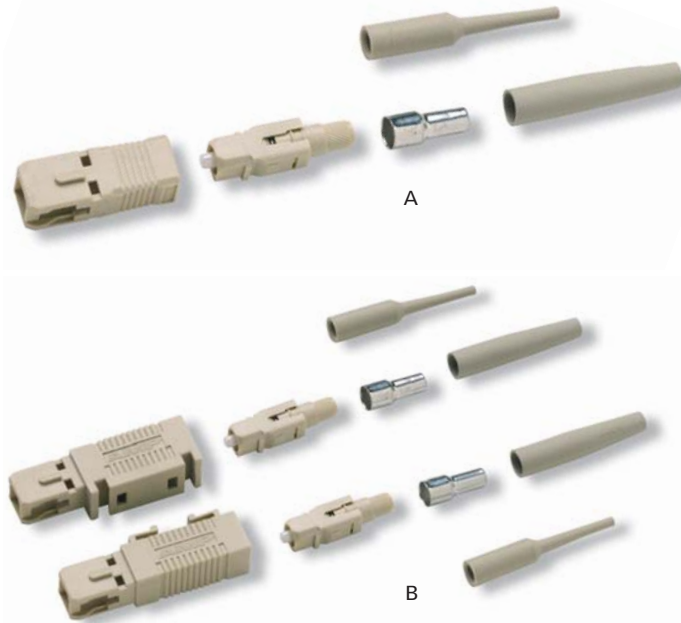

Product Facts

- Each connector kit comes with accessories needed to terminate to 250 μm fiber, 900 μm tight-buffered fiber, 900 μm easy-strip, buffer tube splitter kits, 2.0 mm or 3 mm cable (select appropriate part number)
- Suitable for use with heat-cured or anaerobic (quick cure) adhesive
 - See Instruction Sheet for recommended anaerobic adhesive
- Pre-radiused ceramic ferrules for easy polishing
- Connectors are six-position tunable
- Multimode connectors are suitable for use with 50/125 μm, XG (850 nm LO 50/125 μm) and 62.5/125 μm fibers
- Duplex SC can be assembled using two Simplex SC connectors and one duplex clip
- Mates with standard couplers, adapters, and adapter plates
- Duplex kits have two connectors with interlocking housings

Description	Fiber Type	Housing	Boot Color	Used With	Figure	Part Number
Simplex	Single-mode	Blue	Blue	900μm & 250μm Fibers 3.0mm Cable	–	5504646-7
				3.0mm Cable	–	5504646-1
				900μm & 250μm Fibers 2.0 mm Cable	–	5492123-1
				2.0 mm Cable	–	5504934-2
	XG 850nm LO 50/125 μm	Beige	Aqua	900μm Buffer, 3.0mm Cable	–	1-5503948-1
				3.0mm Cable	–	1-5503948-0
				900μm & 250μm Fibers 2.0 mm Cable	–	5504932-5
				2.0 mm Cable	–	5504931-5
	50/125 μm	Beige	Black	900μm & 250μm Fibers, 3.0mm Cable	–	1-5503948-2
				3.0mm Cable	–	1-5503948-3
				900μm & 250μm Fibers 2.0 mm Cable	–	5504932-1
				2.0 mm Cable	–	5504931-6
62.5/125 μm	Beige	Beige	900μm Buffer, 3.0mm Cable	A	5503948-5	
			3.0mm Cable	–	5503948-1	
			900μm & 250μm Fibers 2.0 mm Cable	–	5504932-6	
			2.0 mm Cable	–	5504931-1	
Duplex	Single-mode	Blue	Blue	3.0mm Cable	–	5504655-1
				2.0 mm Cable	–	5504936-2
	XG 850nm LO 50/125 μm	Beige	Aqua	3.0mm Cable	–	5504657-8
				2.0 mm Cable	–	5504928-3
	50/125 μm	Beige	Black	3.0mm Cable	–	5504657-9
				2.0 mm Cable	–	5504928-4
	62.5/125 μm	Beige	Beige	3.0mm Cable	B	5504657-1
				2.0 mm Cable	–	5504928-1
SC Duplex Clip		Black	2 pieces make 1 clip (for use with Simplex kits)			6348522-1

Epoxy/Polish Connectors and Mechanical Splices

ST Connectors (Epoxy/Polish)



Product Facts

- Each connector kit comes with accessories needed to terminate to 250 μm fiber, 900 μm tight-buffered fiber, 900 μm easy-strip, buffer tube splitter kits, and 3 mm cable (select appropriate part number)
- Boot type and coupling nut options (select appropriate part number)
- Suitable for use with heat-cured or anaerobic (quick cure) adhesive
 - See Instruction Sheet for recommended anaerobic adhesive
- Pre-radiused ceramic ferrules for easy polishing
- Multimode connectors are suitable for use with 50/125 μm, XG (850 nm LO 50/125 μm) and 62.5/125 μm fibers
- Mates with all standards compliant couplers, adapters, and adapter plates

2.2

Fiber Type	Ferrule Type	Body	Coupling Nut	Boot Color	Used With	Part Number
Single-mode	Ceramic	Nickel-plated Brass	Zinc	Yellow (900um)	900μm & 250μm Fibers	5503613-2
				Yellow (Bend-Limiting)	900μm & 250μm Fibers 3.0mm Cable	5502579-2
				Yellow (Short)	900μm & 250μm Fibers 3.0mm Cable	5502580-2
Multimode	Ceramic	Polymer	Polymer	Black (Short & 900um)	900μm & 250μm Fibers 3.0mm Cable	5503571-3
				Black (Short & 900um)	900μm & 250μm Fibers 3.0mm Cable	5492458-1
		Nickel-plated Brass	Zinc	Black (Short)	3.0mm Cable	1-5501380-6
				Black (Bend-Limiting & 900um)	900μm & 250μm Fibers 3.0mm Cable	5501380-1

CORELINK Optical Fiber Splices



Product Facts

- Each CORELINK splice mates two 900 μm tight-buffered fibers or two 250 μm coated fibers
- Easy to install
- Reusable
- No bench tool required
- Splices sold in packs of 12
 - Includes 2 actuator keys
- Optional CORELINK installation tool shown in Chapter 2.7

Description	Part Number
CORELINK Splice Single-mode /Multimode Clear	503577-1
2 Replacement keys in key holder	503681-1

99

Couplers & Adapters

2.2

Couplers & Adapters

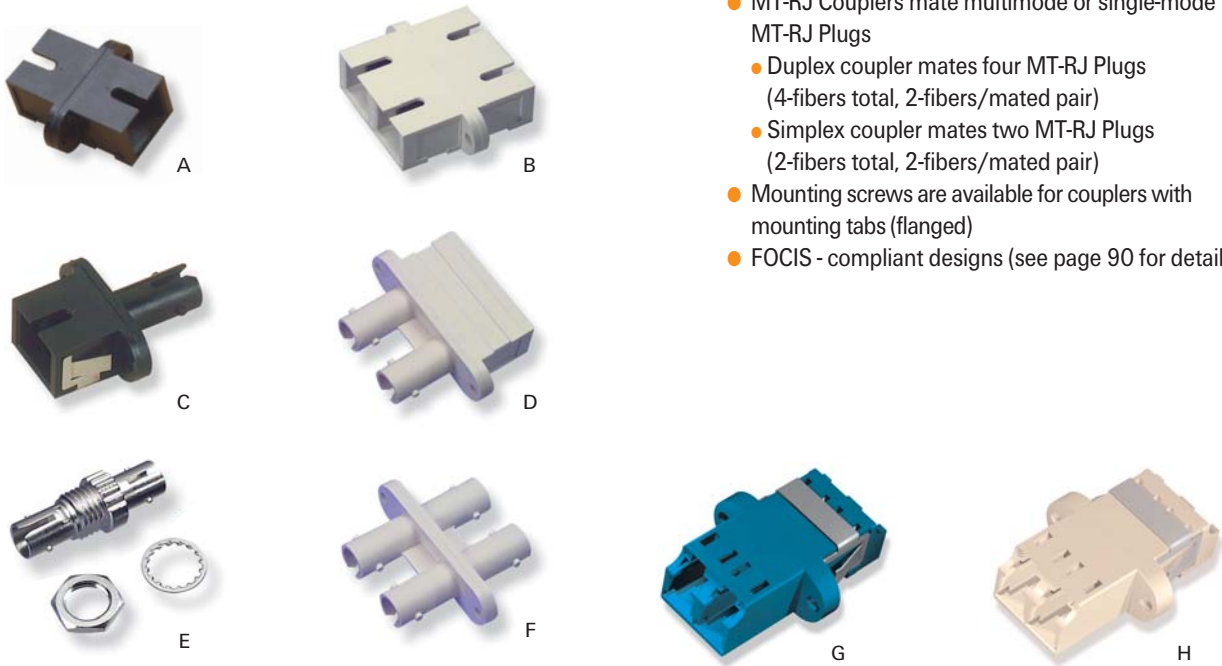

Product Facts

- MT-RJ Couplers mate multimode or single-mode MT-RJ Plugs
- Duplex coupler mates four MT-RJ Plugs (4-fibers total, 2-fibers/mated pair)
- Simplex coupler mates two MT-RJ Plugs (2-fibers total, 2-fibers/mated pair)
- Mounting screws are available for couplers with mounting tabs (flanged)
- FOCIS - compliant designs (see page 90 for details)

Description			Color	Figure	Part Number
MT-RJ Coupler	Single-mode and Multimode	Simplex	Light Almond	–	1278017-1
		Duplex	Almond	–	6374906-1
SC Coupler	Single-mode	Simplex	Blue	A	5502632-8
		Duplex	Blue	–	1-5502776-1
		Simplex	Beige	–	5504614-1
		Simplex	Aqua	–	2-5502632-4
	Multimode	Simplex	Black	–	5502632-7
		Duplex	Beige	B	5504640-1
		Duplex	Aqua	–	2-5502776-6
		Duplex	Black	–	5502776-7
SC to ST Coupling Adapter	Single-mode	Simplex	Blue	–	5502780-2
		Duplex	Blue	–	5503137-5
		Simplex	Beige	–	5502780-3
		Simplex	Aqua	–	2-5502780-1
	Multimode	Simplex	Black	C	5502780-1
		Duplex	Beige	D	5504663-4
		Duplex	Aqua	–	1-5503137-9
		Duplex	Black	–	5503137-1
ST Coupler	Single-mode	Simplex	Metallic	E	504021-1 504021-2*
		Duplex	Blue	–	503273-5
	Multimode	Simplex	Metallic	–	501381-1
		Duplex	Beige	F	504662-2
LC Coupler	Single-mode	Simplex	Blue	–	1457062-1
		Duplex	Blue	G	6457567-4
		Quad	Blue	–	1695790-4
	Multimode	Duplex	Beige	H	6457567-5
		Duplex	Aqua	–	1-6457567-6
		Duplex	Black	–	1-6457567-7

*Note: Bulk packaging (50)

SL Series Optical Fiber Multimedia Inserts

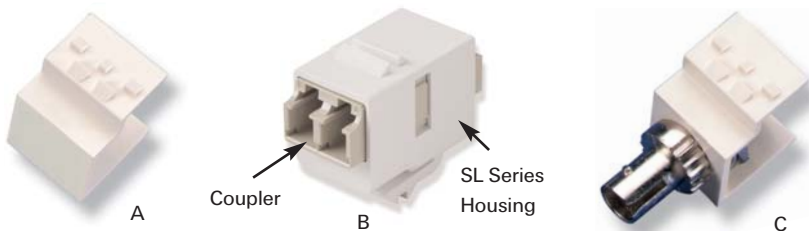

Description	Fiber Type	Figure	LC Coupler and Housing Color	Part Number
Blank		A	—	1116412-X
	62.5/125um	B	Beige	1-1933284-2
	50/125um		Black	1-1933284-1
LC Coupler	XG (LO 850nm 50/125um)		Aqua	1933284-6
	Single-mode		Blue	1933286-4
	Single-mode APC		Green	1933286-3
	Multimode or Single-mode	—	—	1499836-X
SC Simplex Coupler				
	Multimode	C	—	1339123-X
ST Coupler	Single-mode	C	—	1479181-X
		D	—	1374416-Y

X denotes insert color: -1 = Almond, -2 = Black, -3 = White, -4 = Gray, 1--1 = Electrical Ivory

Y denotes color: -1 = Almond, -2 = Black, -3 = White, -4 = Gray, -5 = Orange, -6 = Blue, -7 = Red, -8 = Yellow, -9 = Green, 1--0 = Violet, 1--1 = Electrical Ivory, 2--3 = Rose, 2--4 = Aqua, 2--5 = Brown, 2--6 = Slate

Product Facts

- Provide connections for different media types
- Configure faceplates to handle various services
- May be used in straight or angled faceplate modules
- Inserts easily snap into SL Series Modules, mounting straps, SL Series patch panels, and standard faceplates
- MT-RJ SL Series housing accepts one MT-RJ Jack sold separately (see this Chapter)
- For LC SECURE couplers, see Chapter 4

2.2

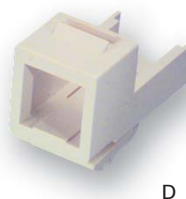

SL Series Optical Fiber Multimedia Modules

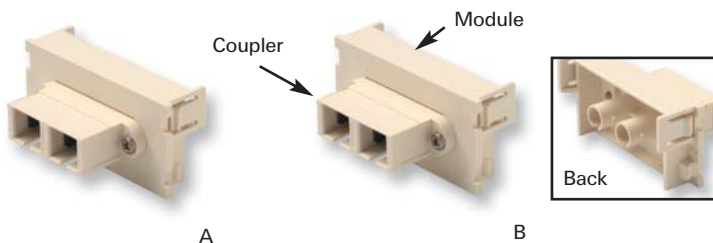

Description	Coupler Type	Fiber Type	Faceplate Units	Figure	Coupler Color	Part Number
2-Fiber Coupler	Duplex SC	Single-mode	1	—	Blue	1375306-X
		Multimode	1	A	Almond	1375123-X
	Duplex SC to ST	Multimode	1	B	Almond	1375241-X

X denotes module color: -1 = Almond, -2 = Black, -3 = White, -4 = Gray, 1--1 = Electrical Ivory

Product Facts

- SL Series Modules fit in SL series Faceplates (see Chapter 3)
- Front loading for ease of installation
- Optical Fiber Coupler Modules are suitable for use with single-mode or multimode connectors as listed

101

OPTICAL FIBER CABLE ASSEMBLIES

MPO Trunk Cable Assemblies	105
MT-RJ Cable Assemblies	106-107
MT-RJ to SC Cable Assemblies	106
MT-RJ to ST Cable Assemblies	107
MT-RJ to LC Cable Assemblies	107
SC Cable Assemblies	108
SC to ST Cable Assemblies	108
SC to LC Cable Assemblies	108
ST Cable Assemblies	109
LC Cable Assemblies	109
Pigtail Plug and Jack (Single-Ended) Cable Assemblies	110
MT-RJ Pigtail Jack (Single-Ended) Cable Assemblies	110
MT-RJ Pigtail Plug (Single-Ended) Cable Assemblies	110
SC Pigtail (Single-Ended) Cable Assemblies	110
LC Pigtail (Single-Ended) Cable Assemblies	110
MT-RJ Test Cable Assemblies	111
MT-RJ OTDR Test Assemblies	111
MT-RJ Loopbacks	111
MT-RJ Test Kits	111
LC Test Kits	112

Chapter Summary

- A complete line of cable assemblies for virtually any communications scenario
- Factory-terminated and tested
- Manufactured using quality AMP NETCONNECT cable and connectors
- Available in 50/125 μm, XG and 62.5/125 μm Multimode and Single-mode
- Available connector styles include MT-RJ, SC, ST, LC and MPO
- Feature connectors with ceramic ferrules
- Call for quotes on custom cable assemblies
- Most standard cable assemblies are shipped within one week, special configuration cable assemblies can be shipped within two weeks
- Selected LSZH cable assemblies available upon request - contact your local NETCONNECT representative for more information

2.3



Optical Fiber Cable Assembly Information

2.3

Optical Fiber Cable Assembly Performance Details

Test Description	FOTP*	Requirement
Visual and Mechanical Inspection:	MT-RJ - 13	TIA/EIA-604-12 (FOCIS 12)
	SC - 13	TIA/EIA-604-3 (FOCIS 3)
	ST - 13	TIA/EIA-604-2 (FOCIS 2)
	LC - 13	TIA/EIA-604-10 (FOCIS 10)
Attenuation	34	≤ 0.75 dB
Return Loss	107	≤ -20 dB
Low Temperature (0° C for 4 days)	188	≤ 0.3 dB change
Temperature Life (55° C for 14 days)	7	≤ 0.3 dB change
Humidity (90 to 95% @ 40° C for 4 days)	5	≤ 0.3 dB change
Impact (8 drops from 1.8 m)	2	≤ 0.75 dB IL, ≤ -20 dB RL
Durability (500 cycles)	21	≤ 0.75 dB IL, ≤ -20 dB RL
Cable Retention (0° and 90°)	6	≤ 0.75 dB IL, ≤ -20 dB RL
Flex (100 cycles)	1	≤ 0.75 dB IL, ≤ -20 dB RL
Twist (10 cycles)	36	≤ 0.75 dB IL, ≤ -20 dB RL

*Note: FOTP = Fiber Optic Test Procedure per TIA/EIA - 455-XX series.
FOCIS = Fiber Optic Connector Interchangeability Standard.

Optical Fiber Cable Assembly Length Reference

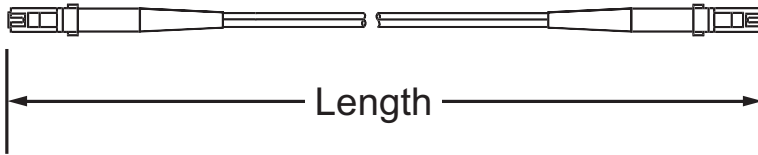

Meter to Foot and Inch Reference

Length in Meters	Length in Feet	Length in Inches
1	3.28	39.37
2	6.56	78.74
3	9.84	118.11
4	13.12	157.48
5	16.40	196.85
6	19.68	236.21
7	22.96	275.59
8	26.25	314.96
9	29.52	354.33
10	32.80	393.70
20	65.62	787.40
30	98.42	1181.10
40	131.23	1574.80
50	164.04	1968.50
60	196.85	2362.20
70	229.66	2755.90
80	262.47	3149.60
90	295.27	3543.30
100	328.08	3937.00
110	360.89	4330.69
120	393.70	4724.39
130	426.51	5118.09
140	459.32	5511.79
150	492.12	5905.49
160	524.93	6299.19
170	557.74	6692.89
180	590.55	7086.59
190	623.36	7480.29
200	656.17	7873.99

Note: Conversion chart is for reference only and does not imply actual assembly length.

Fiber Polarity

Fiber Color	Left Connector	Right Connector
White	A	B
Blue	B	A

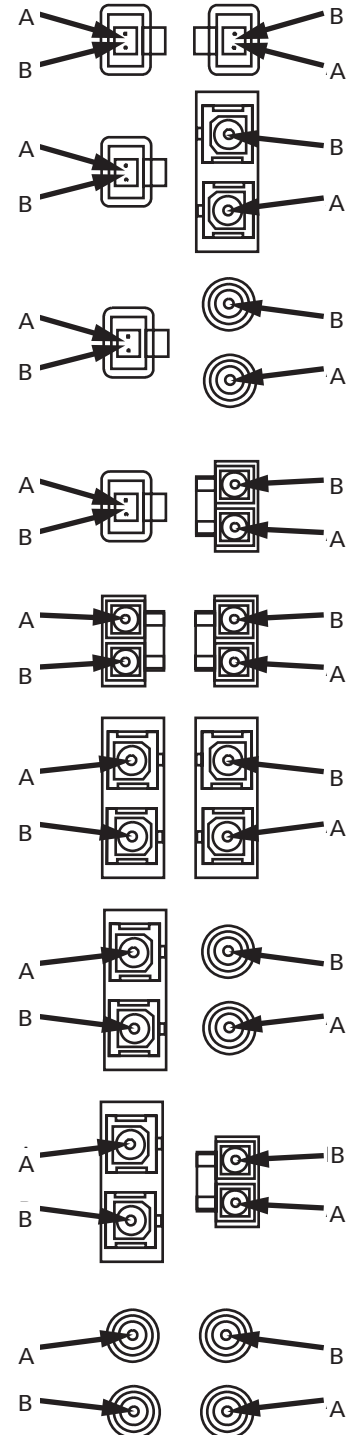

MPO Trunk Cable Assemblies



with Pulling Socks

Product Facts

- Trunk cable fiber polarity is Pair-Flipped AB/BA (see polarity diagram Chapter 2.4)
- Trunk cables with Pair-Straight AB/AB polarity are available
- Pulling socks protect MPO terminations during installation
- Twelve (12) fibers per MPO plug
- Trunk cables come pre-tested and ready for immediate use
- 12 and 24 fiber MPO Trunk cables meet or exceed the requirements of GR-409-CORE and UL/NEC rating for Riser and Plenum applications.
- Plenum Cables can be used in riser spaces
- Additional counts and lengths are available

Description	Fiber Type	UL/NEC Ratings	Jacket Color	Part Number
12-Fiber, Pair-Flipped (AB/BA)	50/125 μm	Plenum (OFNP) Riser (OFNR)	Orange	6435028-X
	XG (850 nm LO 50/125 μm)	Plenum (OFNP) Riser (OFNR)	Aqua	1907404-X
	62.5/125 μm	Plenum (OFNP) Riser (OFNR)	Orange	6435024-X
	Single-mode	Plenum (OFNP) Riser (OFNR)	Yellow	6435070-X
24-Fiber, Pair-Flipped (AB/BA)	50/125 μm	Plenum (OFNP) Riser (OFNR)	Orange	6435029-X
	XG (850 nm LO 50/125 μm)	Plenum (OFNP) Riser (OFNR)	Aqua	1754687-X
	62.5/125 μm	Plenum (OFNP) Riser (OFNR)	Orange	6435025-X
	Single-mode	Plenum (OFNP) Riser (OFNR)	Yellow	6754882-X
72-Fiber, Pair-Flipped (AB/BA)	50/125 μm	Plenum (OFNP) Riser (OFNR)	Orange	6435031-X
	XG (850 nm LO 50/125 μm)	Plenum (OFNP)	Aqua	1828803-X
	62.5/125 μm	Plenum (OFNP) Riser (OFNR)	Orange	6435027-X
	62.5/125 μm	Riser (OFNR)	Orange	6435035-X

X denotes length in feet: -1 = 10, -2 = 20, -3 = 30, -4 = 40, -5 = 50, -6 = 60, -7 = 70, -8 = 80, -9 = 90, 1--0 = 100, 1--1 = 110, 1--2 = 120, 1--3 = 130, 1--4 = 140, 1--5 = 150, 1--6 = 160, 1--7 = 170, 1--8 = 180, 1--9 = 190, 2--0 = 200, 2--1 = 210, 2--2 = 220, 2--3 = 230, 2--4 = 240, 2--5 = 250, 2--6 = 260, 2--7 = 270, 2--8 = 280, 2--9 = 290, 3--0 = 300

MT-RJ and MT-RJ to SC Cable Assemblies

2.3

MT-RJ Cable Assemblies



Product Facts

- Each MT-RJ connector houses two fibers
- Cable assemblies are riser-rated
- For MT-RJ SECURE assemblies, see Chapter 4

Connector End 1	Connector End 2	Fiber Type	Jacket Color	UL/NEC Rating	Part Number
MT-RJ	MT-RJ	50/125 μm	Orange	OFNR	6278128-X
		XG (850 nm 50/125 μm)	Aqua	OFNR	6588572-X
		62.5/125 μm	Orange	OFNR	6278032-X
		Single-mode	Yellow	OFNR	6278033-X

X denotes length in meters: -1 = 1, -2 = 2, -3 = 3, -5 = 5, 1--0 = 10

MT-RJ to SC Cable Assemblies



Product Facts

- Connects between equipment with different interfaces
- SC connectors feature ceramic ferrules
- Each MT-RJ Connector houses two fibers
- For MT-RJ SECURE assemblies, see Chapter 4

Connector End 1	Connector End 2	Fiber Type	Jacket Color	UL/NEC Rating	Part Number
MT-RJ	Duplex SC	50/125 μm	Orange	OFNR	6278126-X
		XG (850 nm 50/125 μm)	Aqua	OFNP	1907429-X
		62.5/125 μm	Orange	OFNR	6278028-X
		Single-mode	Yellow	OFNR	6278031-X
	Simplex SC	50/125 μm	Orange	OFNR	6278127-X
		XG (850 nm 50/125 μm)	Aqua	OFNR	6588573-X
		62.5/125 μm	Orange	OFNR	6278030-X

X denotes length in meters: -1 = 1, -2 = 2, -3 = 3, -5 = 5, 1--0 = 10

MT-RJ to ST Cable Assemblies



Product Facts

- Connects between equipment with different interfaces
- ST Connectors feature ceramic ferrules
- Each MT-RJ Connector houses two fibers
- Cable assemblies are riser-rated
- For MT-RJ SECURE assemblies, see Chapter 4

2.3

Connector End 1	Connector End 2	Fiber Type	Jacket Color	UL/NEC Rating	Part Number
MT-RJ	Dual ST	50/125 μm	Orange	OFNR	6278199-X
		62.5/125 μm	Orange	OFNR	1907441-X
		Single-mode	Yellow	OFNR	6278298-X

X denotes length in meters: -1 = 1, -2 = 2, -3 = 3, -5 = 5, 1--0 = 10

MT-RJ to LC Cable Assemblies

Product Facts

- Connects between equipment with different interfaces
- One Duplex LC Connector and one MT-RJ Plug
- LC Connectors feature ceramic ferrules
- Cable Assemblies are riser-rated
- Each MT-RJ Connector houses two fibers
- For MT-RJ SECURE assemblies, see Chapter 4

Connector End 1	Connector End 2	Fiber Type	Jacket Color	UL/NEC Rating	Part Number
MT-RJ	LC Duplex	50/125 μm	Orange	OFNR	6374647-X
		XG (850 nm LO 50/125 μm)	Aqua	OFNR	1907440-X
		62.5/125 μm	Orange	OFNR	6374646-X
		Single-mode	Yellow	OFNR	6374645-X

X denotes length in meters: -1 = 1, -2 = 2, -3 = 3, -5 = 5, 1--0 = 10

MT-RJ Plug to MT-RJ Right Angle Jack

Product Facts



- Form connections between work area and consolidation point
- Factory-assembled and tested
- Save time and money on moves, adds and changes

Description	Jacket Color	Part Number
50/125 μm OFNR (Riser)	Orange	6457240-X

X denotes length in feet: -1 = 10, -2 = 20, -3 = 30, -4 = 40, -5 = 50

107

SC Cable Assemblies

2.3

SC Cable Assemblies



Product Facts

- Cable assemblies are riser-rated
- Connector features ceramic ferrules

Connector End 1	Connector End 2	Fiber Type	Jacket Color	UL/NEC Rating	Part Number
SC Duplex	SC Duplex	50/125 μm	Orange	OFNR	1907379-X
		XG (850 nm LO 50/125 μm)	Aqua	OFNR	6828151-X
		62.5/125 μm	Orange	OFNR	1907434-X
		Single-mode	Yellow	OFNR	1907435-X

X denotes length in meters: -1 = 1, -2 = 2, -3 = 3, -5 = 5, 1--0 = 10

SC to ST Cable Assemblies



Product Facts

- Connects between equipment with different interfaces
- Cable assemblies are riser-rated
- Connectors feature ceramic ferrules

Connector End 1	Connector End 2	Fiber Type	Jacket Color	UL/NEC Rating	Part Number
SC Duplex	Dual ST	50/125 μm	Orange	ONFR	5492591-X
		XG (850 nm LO 50/125 μm)	Aqua	OFNR	1907339-X
		62.5/125 μm	Orange	OFNR	1907385-X
		Single-mode	Yellow	OFNR	1907357-X

X denotes length in meters: -1 = 1, -2 = 2, -3 = 3, -5 = 5, 1--0 = 10

SC to LC Cable Assemblies

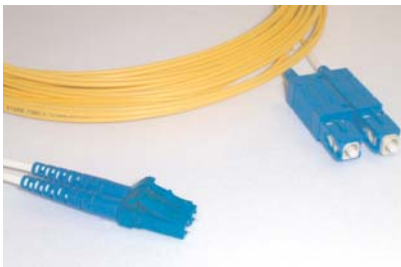

Product Facts

- Connects between equipment with different interfaces
- Connectors feature ceramic ferrules
- Cable Assemblies are riser-rated
- For LC SECURE assemblies, see Chapter 4

Connector End 1	Connector End 2	Fiber Type	Jacket Color	UL/NEC Rating	Part Number
SC Duplex	LC Duplex	50/125 μm	Orange	OFNR	1907380-X
		XG (850 nm LO 50/125 μm)	Aqua	OFNR	1907438-X
		62.5/125 μm	Orange	OFNR	1906777-X
		Single-mode	Yellow	OFNR	1906768-X

X denotes length in meters: -1 = 1, -2 = 2, -3 = 3, -5 = 5, 1--0 = 10

ST Cable Assemblies



Product Facts

- Connectors feature ceramic ferrules
- Cable assemblies are riser-rated

2.3

Connector End 1	Connector End 2	Fiber Type	Jacket Color	UL/NEC Rating	Part Number
Dual ST	Dual ST	50/125 μm	Orange	OFNR	6278207-X
		XG (850nm LO 50/125 nm)	Aqua	OFNR	1907557-X
		62.5/125 μm	Orange	OFNR	1907436-X
		Single-mode	Yellow	OFNR	1907437-X

X denotes length in meters: -1 = 1, -2 = 2, -3 = 3, -5 = 5, 1--0 = 10
 Y denotes length in meters: -1 = 1, -2 = 2, -3 = 3, -4 = 5, -5 = 10

LC Cable Assemblies

Product Facts

- Connectors feature ceramic ferrules
- Cable Assemblies are riser-rated
- For LC SECURE assemblies, see Chapter 4

Connector End 1	Connector End 2	Fiber Type	Jacket Color	UL/NEC Rating	Part Number
LC Duplex	LC Duplex	50/125 μm	Orange	OFNR	1906866-X
		XG (850 nm LO 50/125 μm)	Aqua	OFNR	6828317-X
		62.5/125 μm	Orange	OFNR	1906865-X
		Single-mode	Yellow	OFNR	1906856-X

X denotes length in meters: -1 = 1, -2 = 2, -3 = 3, -5 = 5, 1--0 = 10

109

Single-Ended Cable Assemblies

2.3

MT-RJ Pigtail Jack (Single-Ended) Cable Assemblies

Description	Color	Fiber Type	Part Number
MT-RJ Jack	Black	50/125 μm	6374018-X
	Gray	XG (850 nm LO 50/125 μm)	1938008-X
	Beige	62.5/125 μm	6374019-X
	Blue	Single-mode	6374020-X

X denotes length in meters: -1 = 1, -2 = 2, -3 = 3

Product Facts

- Compatible with MT-RJ Jack Snap-in Adapter Plates
- Two 250 μm coated fiber in protective 900 μm tubing
- Compatible with fusion or mechanical splices
- Each MT-RJ Connector houses two fibers

MT-RJ Pigtail Plug (Single-Ended) Cable Assemblies

Description	Fiber Type	Part Number
MT-RJ Plug	50/125 μm	6588849-X
	XG (850 nm LO 50/125 μm)	1985275-X
	62.5/125 μm	6693532-X
	Single-mode	6693533-X

X denotes length in meters: -1 = 1, -2 = 2, -3 = 3

Product Facts

- Compatible with MT-RJ Plug Snap-in Adapter Plates
- Two 250 μm coated fiber in protective 900 μm tubing
- Compatible with fusion or mechanical splices
- MT-RJ Plugs are pinned
- Each MT-RJ Connector houses two fibers
- For MT-RJ SECURE assemblies, see Chapter 4

SC Pigtail (Single-Ended) Cable Assemblies

Fiber Type	Part Number
Single-mode	Simplex SC - APC 3.0 mm Jacketed 5492193-X
	Simplex SC - UPC 3.0 mm Jacketed 5492081-X
	900 μm Buffered 5492065-X

X denotes length in meters: -1 = 1, -2 = 2, -3 = 3

Product Facts

- Compatible with SC Snap-in Adapter Plates
- Spliceable pigtail assembly
- 250 μm coated fiber in protective 900 μm tubing
- Compatible with fusion or mechanical splices

LC Pigtail (Single-Ended) Cable Assemblies

Connector End 1	Connector End 2	Fiber Type	Part Number
LC Simplex, 1 m	2.0 mm Jacketed	50/125 μm	6754404-1
		XG (850 nm LO 50/125 μm)	6754402-1
		62.5/125 μm	6754400-1
		Single-mode	6754401-1

Product Facts

- Compatible with LC Snap-in Adapter Plates
- Spliceable pigtail assembly
- 250 μm coated fiber in protective 900 μm tubing
- Compatible with fusion or mechanical splices

MT-RJ Test Cable Assemblies

MT-RJ OTDR Test Assemblies

Description	Connector End 1	Connector End 2	Fiber Type	Part Number
Launch Lead	MT-RJ	Dual SC Simplex	50/125 μm	6588080-1
			62.5/125 μm	6588079-1
		Dual ST	50/125 μm	6588078-1
			62.5/125 μm	6588077-1

Product Facts

- For use in testing with an OTDR test set
- All assemblies are 100m in length
- For XG fiber testing, use standard 50/125 μm Multimode products

2.3

MT-RJ Loopbacks

Description	Fiber Type	Part Number
MT-RJ Loopback	50/125 μm	6278357-1
	62.5/125 μm	6278153-1
	Single-mode	6278358-1

Product Facts

- For XG fiber testing, use standard 50/125 μm Multimode products

MT-RJ Test Kits



Connector End 1	Connector End 2	Fiber Type	Part Number
MT-RJ	Dual ST	50/125 μm	1278861-2
		62.5/125 μm	1278862-2
		Single-mode	1278863-2
	SC Duplex	50/125 μm	1278861-1
		62.5/125 μm	1278862-1
		Single-mode	1278863-1

Product Facts

- Each Test Kit includes:
 - 1 - MT-RJ Adapter
 - 2 - MT-RJ (no pins) to SC Simplex or ST Cable Assemblies
 - 1 - MT-RJ (with pins) to SC Simplex or ST Cable Assembly
 - 1 - MT-RJ to MT-RJ Cable Assembly
 - 2 - Mandrels (not included with Single-mode Kit)
 - 1 - Carrying case
- Test Kits for MT-RJ SECURE Connector Systems also available
- See "MT-RJ OPTICAL FIBER SYSTEMS TESTING" White Paper (available on-line at www.ampnetconnect.com) for details
- For XG fiber testing, use standard 50/125 μm Multimode products

Replacement Components for MT-RJ Test Kits

Connector End 1	Connector End 2	Fiber Type	Part Number		
Unpinned MT-RJ	Unpinned MT-RJ	50/125 μm	6435096-2		
		62.5/125 μm	6435096-1		
		Single-mode	6435096-3		
		50/125 μm	6435092-2		
		SC	62.5/125 μm	6435092-1	
			Single-mode	6435092-3	
	ST	50/125 μm	6435094-2		
			62.5/125 μm	6435094-1	
		Single-mode	6435094-3		
			50/125 μm	6435096-5	
		Pinned MT-RJ	Pinned MT-RJ	62.5/125 μm	6435096-4
				Single-mode	6435096-6
50/125 μm	6435092-5				
SC	62.5/125 μm		6435092-4		
	Single-mode		6435092-6		
	50/125 μm		6435094-5		
ST	62.5/125 μm	6435094-4			
	Single-mode	6435094-6			

Product Facts

- All assemblies are 4 m in length
- Pinned MT-RJ Cable Assemblies are used for testing only
- Cable Assemblies are riser-rated
- For XG fiber testing, use standard 50/125 μm Multimode products

111

LC Test Kits and Replacement Cables

2.3

LC Test Kits

Description	Fiber Type	Part Number
For use with Dual Fiber Testers with SC Transmit and LC Receive Ports	50/125 μm / XG 50/125 μm	1828867-1
	62.5/125 μm	1828868-1
	Single-mode	1828869-1
For use with Dual Fiber Testers with ST Transmit and LC Receive Ports	50/125 μm / XG 50/125 μm	1828867-2
	62.5/125 μm	1828868-2
	Single-mode	1828869-2
For use with Dual Fiber Testers with LC Transmit and LC Receive Ports	50/125 μm / XG 50/125 μm	1828867-3
	62.5/125 μm	1828868-3
	Single-mode	1828869-3

Product Facts

- Test Kits includes:
 - Cable Assemblies
 - LC Duplex Clips
 - Mandrels (not included with Single-mode Kit)
 - Carrying case
- Test Kits for LC SECURE Connector Systems also available
- See "FIELD TESTING LC OPTICAL FIBER SYSTEMS" White Paper (available on-line at www.ampnetconnect.com) for test details

Replacement Components for LC Test Kits

Description	Fiber Type	Part Number
Mandrels (Transmit side only)	50/125 μm / XG 50/125 μm	1435119-1
	62.5/125 μm	1435118-1
	Single-mode	-
LC Duplex Clips (pack of 6)	50/125 μm / XG 50/125 μm	1754371-2
	62.5/125 μm	
	Single-mode	
SC to LC Simplex Assembly, 3m	50/125 μm / XG 50/125 μm	1907490-3
	62.5/125 μm	1907491-3
	Single-mode	1907489-3
ST to LC Simplex Assembly, 3m	50/125 μm / XG 50/125 μm	1907493-3
	62.5/125 μm	1907494-3
	Single-mode	1907492-3
LC to LC Simplex Assembly, 3m	50/125 μm / XG 50/125 μm	1907496-3
	62.5/125 μm	1907497-3
	Single-mode	1907495-3

Product Facts

- Assemblies are 3m in length
- Assemblies are Simplex style
- Cable Assemblies are riser-rated

OPTICAL FIBER DATA CENTER/SAN PRODUCTS

MPO and PARA-OPTIX System Polarity	114
PARA-OPTIX Cabling System	115
MPO Trunk Cable Assemblies	116
MPO Cassettes	117

2.4

Chapter Summary

- PARA-OPTIX trunk cables pre-terminated with high-density MPO 72-fiber connectors
- MPO trunk cables pre-terminated with high-density MPO 12-fiber connectors
- Cassettes offer MPO fiber break out in convenient and easy-to-install package
- Simple, flexible fiber cabling system for LAN, SAN and Data Center installations
- Best combination of high data rates, fast installation and reliability

2.4



MPO and PARA-OPTIX Polarity

2.4

System Polarity with MPO Pair-Flipped AB/BA Trunk Cable

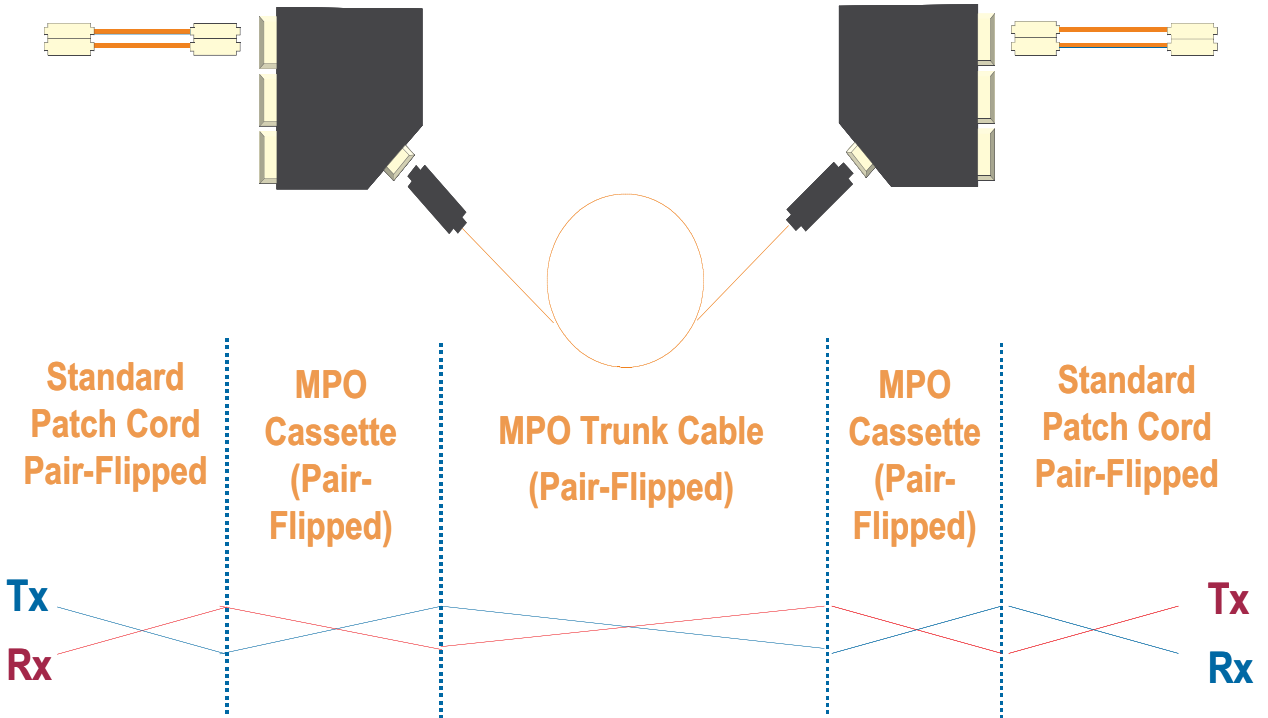

System Polarity with PARA-OPTIX Pair-Straight AB/AB Trunk Cable

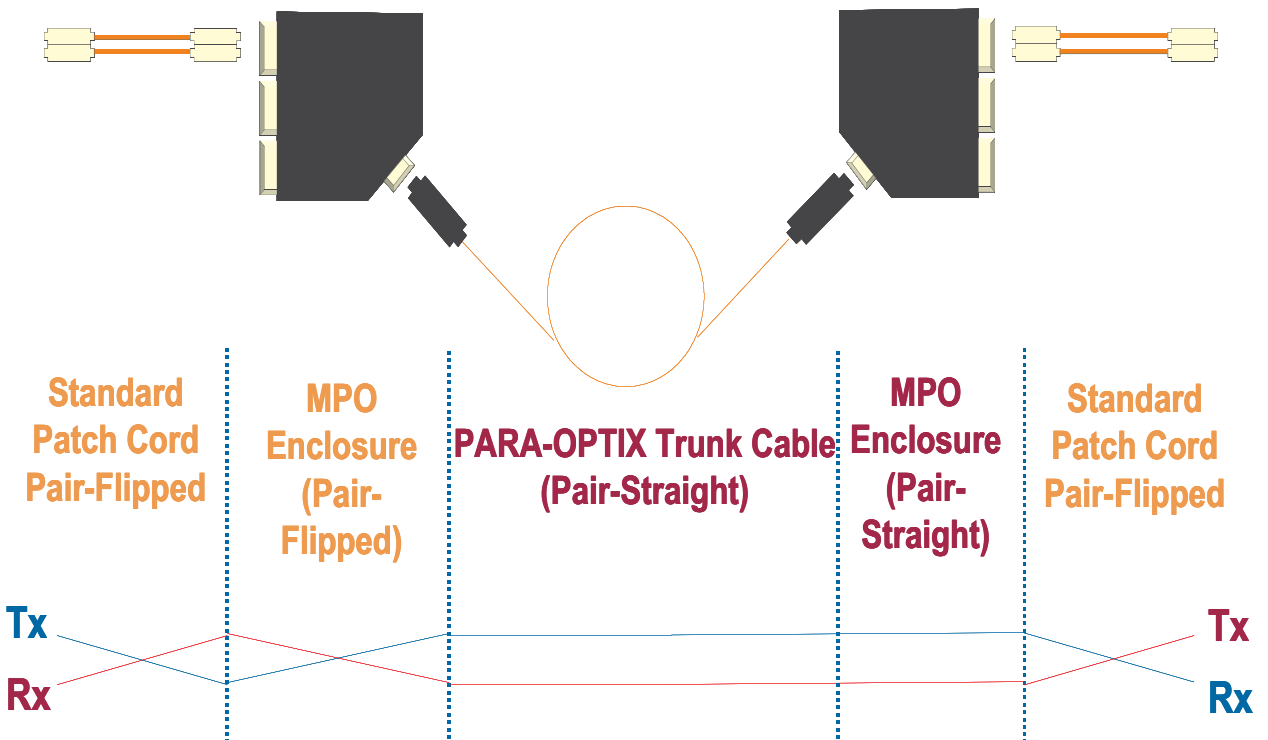

114

PARA-OPTIX Backbone Enclosure Kit Part Number 1919547-1

Kit Includes:

- : 1 Pair-Straight AB/AB PARA-OPTIX Enclosure
- : 1 Pair-Flipped AB/BA PARA-OPTIX Enclosure

Each Enclosure provides 36 LC Duplex Connectors to a single 72 fiber MPO connector interface using XG (850nm LO 50/125 μm) fiber.



Product Facts

- 1U high rack mounted enclosures
- Pre-installed cable management
- High density saves space and installation time

2.4

PARA-OPTIX Trunk Assembly



Product Facts

- 72 XG (850nm LO 50/125 μm) fibers in a single MPO style connector
- Pulling socks protect MPO style terminations during installation
- Trunk cable and Enclosures Pre-tested and ready for installation
- Trunk cable must be connected between Pair-Flipped AB/BA and Pair-Straight AB/AB Enclosure (see polarity diagram)

Description	Fiber Type	UL/NEC Ratings	Jacket Color	Part Number
72 Fiber Trunk Assembly, Pair-Straight AB/AB	XG (850 nm LO 50/125 μm)	Plenum (OFNP)	Aqua	1919505-X

X denotes length in feet: -1 = 10, -2 = 20, -3 = 30, -4 = 40, -5 = 50, -6 = 60, -7 = 70, -8 = 80, -9 = 90, 1--0 = 100, 1--1 = 110, 1--2 = 120, 1--3 = 130, 1--4 = 140, 1--5 = 150, 1--6 = 160, 1--7 = 170, 1--8 = 180, 1--9 = 190, 2--0 = 200, 2--1 = 210, 2--2 = 220, 2--3 = 230, 2--4 = 240, 2--5 = 250, 2--6 = 260, 2--7 = 270, 2--8 = 280, 2--9 = 290, 3--0 = 300

Optional System Products

Description	Fiber Type	UL/NEC Ratings	Jacket Color	Part Number
LC Duplex to LC Duplex Cable Assemblies	XG (850 nm LO 50/125 μm)	Riser (OFNR)	Aqua	6828317-X
		Plenum (OFNP)	Aqua	1907451-X
Rear Cable Management	-	-	-	556561-1
Grounding Lug Kit	-	-	-	556438-1
White Front Labels	-	-	-	1375354-1
Blue Front Labels	-	-	-	1375354-2

X denotes length in meters: -1 = 1, -2 = 2, -3 = 3, -4 = 4, -5 = 5, -6 = 6, -7 = 7

115

MPO Trunk Cable Assemblies

2.4

MPO Trunk Cable Assemblies



with Pulling Socks

Product Facts

- Trunk cable fiber polarity is Pair-Flipped AB/BA (see polarity diagram this Chapter)
 - Trunk cables with Pair-Straight AB/AB polarity are available
- Pulling socks protect MPO terminations during installation
- Twelve (12) fibers per MPO plug
- Trunk cables come pre-tested and ready for installation
- 12 and 24 fiber MPO Trunk cables meet or exceed the requirements of GR-409-CORE and UL/NEC rating for Riser and Plenum applications.
- Plenum Cables can be used in riser spaces
- Custom counts and lengths are available

Description	Fiber Type	UL/NEC Ratings	Jacket Color	Part Number
12-Fiber, Pair-Flipped (AB/BA)	50/125 μm	Plenum (OFNP) Riser (OFNR)	Orange	6435028-X
	XG (850 nm LO 50/125 μm)	Plenum (OFNP) Riser (OFNR)	Aqua	1907404-X
	62.5/125 μm	Plenum (OFNP) Riser (OFNR)	Orange	6435024-X
	Single-mode	Plenum (OFNP) Riser (OFNR)	Yellow	6435070-X
24-Fiber, Pair-Flipped (AB/BA)	50/125 μm	Plenum (OFNP) Riser (OFNR)	Orange	6435029-X
	XG (850 nm LO 50/125 μm)	Plenum (OFNP) Riser (OFNR)	Aqua	1754687-X
	62.5/125 μm	Plenum (OFNP) Riser (OFNR)	Orange	6435025-X
	Single-mode	Plenum (OFNP) Riser (OFNR)	Yellow	6754882-X
72-Fiber, Pair-Flipped (AB/BA)	50/125 μm	Plenum (OFNP) Riser (OFNR)	Orange	6435031-X
	XG (850 nm LO 50/125 μm)	Plenum (OFNP)	Aqua	1828803-X
	62.5/125 μm	Plenum (OFNP) Riser (OFNR)	Orange	6435027-X

X denotes length in feet: -1 = 10, -2 = 20, -3 = 30, -4 = 40, -5 = 50, -6 = 60, -7 = 70, -8 = 80, -9 = 90, 1-0 = 100, 1--1 = 110, 1--2 = 120, 1--3 = 130, 1--4 = 140, 1--5 = 150, 1--6 = 160, 1--7 = 170, 1--8 = 180, 1--9 = 190, 2--0 = 200, 2--1 = 210, 2--2 = 220, 2--3 = 230, 2--4 = 240, 2--5 = 250, 2--6 = 260, 2--7 = 270, 2--8 = 280, 2--9 = 290, 3--0 = 300

MPO Optical Fiber Cassettes

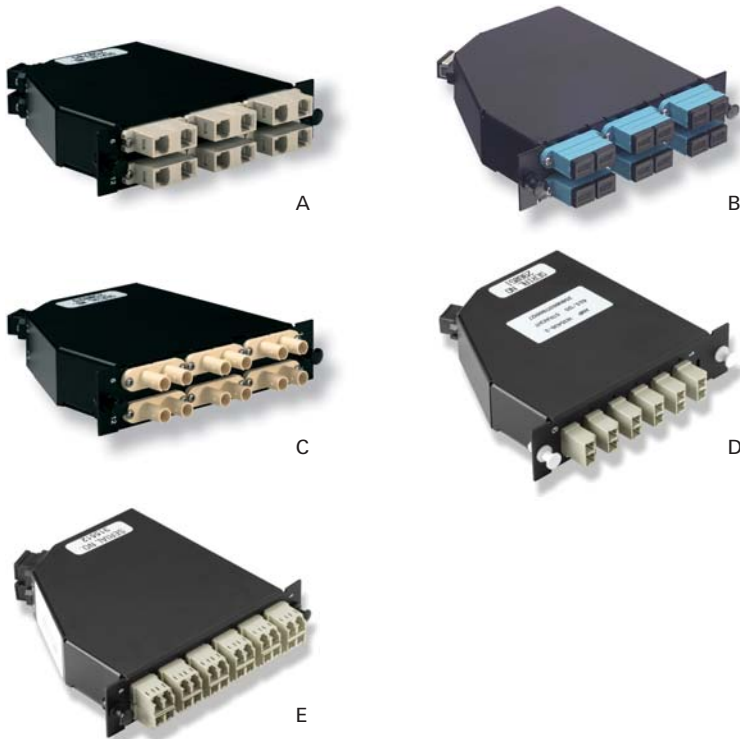

Product Facts

- Cassette fiber polarity is Pair-Flipped (AB/BA)
- Cassettes with polarity Pair-Straight (AB/AB) are available
- Cassettes have one MPO connection (12-Fiber) or two MPO connections (24-Fiber) on the back of each cassette
- Highest density option uses small form factor connectors (MT-RJ or LC)
- Cassettes house one or two MPO 12-fiber break-out assemblies
- Cassettes have same footprint as Snap-in Adapter Plates mount in all AMP NETCONNECT enclosures that accept Snap-in Adapter Plates
- Factory tested and ready for installation

2.4

Description	Fiber Type	Fiber Count	Duplex Port Count	Adapter Color	Figure	Part Number	
MT-RJ	50/125 μm	12	6	Black	–	6754286-1	
		24	12	Black	–	6754288-1	
	XG (850 nm LO 50/125 μm)	12	6	Aqua	–	1918777-1	
		24	12	Aqua	–	1918778-1	
	62.5/125 μm	12	6	Beige	–	6754285-1	
		24	12	Beige	A	6754287-1	
Single-mode		12	6	Blue	–	1938996-1	
		24	12	Blue	–	6828819-1	
SC	50/125 μm	12	6	Black	–	6435181-2	
	XG (850 nm LO 50/125 μm)	12	6	Aqua	–	6754333-2	
	62.5/125 μm	12	6	Black	–	6435180-2	
	Single-mode	12	6	Blue	B	6435069-2	
ST	50/125 μm	12	6	Black	C	6435067-2	
	62.5/125 μm	12	6	Black	C	6278418-2	
LC	50/125 μm	12	6	Black	–	1918779-1	
		24	12	Black	–	1918780-1	
	XG (850 nm LO 50/125 μm)	12	6	Aqua	–	1918783-1	
		24	12	Aqua	–	1918784-1	
	62.5/125 μm	12	6	Beige	D	1918781-1	
		24	12	Beige	E	1918782-1	
	Single-mode		12	6	Blue	–	1938056-1
			24	12	Blue	–	1918786-1

RACK MOUNT ENCLOSURES AND ACCESSORIES

Snap-in Adapter Plates 120-121
 Patch Panels 122
 1U Patch Panel Enclosures 123-124
 2U and 3U Patch Panel Enclosures 125
 4U Patch Panel Enclosures 126
 2U Fiber Storage Enclosure 126
 3U and 4U Splice Enclosure 127
 Splice Trays 127
 2U Splice and Patch Enclosure 128
 Splice Trays 128

Chapter Summary

- Rack mount enclosures provide options for rack placement and protection of fiber terminations
- Complete line of connectivity, splice and size options – up to 288 fibers
- Splice and patch enclosures
- Unloaded enclosures accept AMP NETCONNECT Snap-in Adapter Plates
 - Mix and match connector types in the same enclosure
- Loaded enclosures
- Cable management and accessories

2.5



Snap-In Adapter Plates

2.5

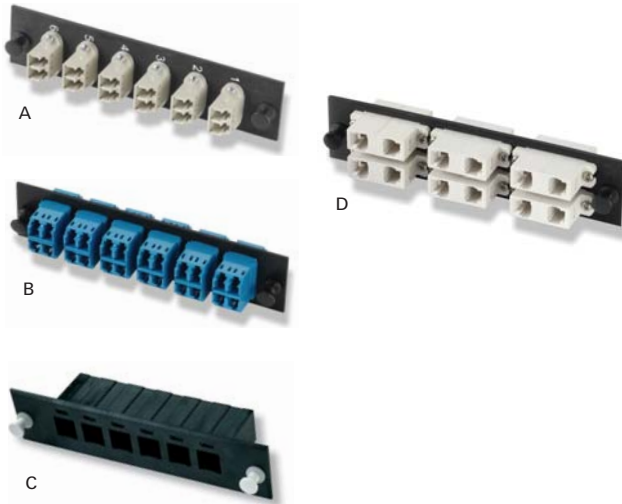

Product Facts

- All Snap-in Adapter Plates fit AMP NETCONNECT unloaded Optical Fiber Enclosures included in this chapter
- MT-RJ Jack Adapter Plates:
 - Hold up to six (6) MT-RJ (standard or secure) Jacks or Pigtail Jack Cable Assemblies
 - Accepts labeling icons in Chapter 8
- MT-RJ Plug Adapter Plates hold up to twelve (12) MT-RJ Plugs (standard only)
- LC SECURE plugs will only mate with the same color LC SECURE adapter.
- Package quantity = 1 per pack

Adapter Description	Fibers	Type	Adapter Color	Figure	Part Number
LC Duplex	12	Multimode (62.5/125,OM1)	Beige	A	1374463-3
		Multimode (50/125,OM2)	Black	-	1374463-4
		Multimode (XG LO 50/125,OM3)	Aqua	-	1374463-5
		Single-mode (UPC)	Blue	-	1374463-1
		Single-mode (APC)	Green	-	1374463-6
LC Duplex	24	Multimode (62.5/125,OM1)	Beige	-	1435516-2
		Multimode (50/125,OM2)	Black	-	1435516-4
		Multimode (XG LO 50/125,OM3)	Aqua	-	1435516-5
		Single-mode (UPC)	Blue	B	1435516-1
		Single-mode (APC)	Green	-	1435516-6
LC SECURE Duplex	24	Multimode/Single-mode	Red	-	1499702-2
		Multimode/Single-mode	Yellow	-	1499703-2
		Multimode/Single-mode	Green	-	1499704-2
		Multimode/Single-mode (UPC Polish)	Blue	-	1499705-2
		Multimode/Single-mode	Rose	-	1499706-2
		Multimode/Single-mode	Aqua	-	1499707-2
		Multimode/Single-mode	Brown	-	1499708-2
		Multimode/Single-mode	Violet	-	1499709-2
		Multimode/Single-mode	Orange	-	1499710-2
		Multimode/Single-mode	Slate	-	1499711-2
MT-RJ, Holds 6 Jacks	12	-	-	C	1278328-3
MT-RJ, 12 Plugs	24	Multimode (62.5/125,OM1)	Beige	D	1435440-1
		Multimode (50/125,OM2)	Black	-	1435440-2
		Single-mode (UPC)	Blue	-	1435440-3
SC Simplex	6	Multimode (62.5/125,OM1)	Beige	-	559517-7
		Multimode (50/125,OM2)	Black	-	559517-3
		Multimode (XG LO 50/125,OM3)	Aqua	-	559517-8
		Single-mode (UPC)	Blue	-	559517-1
		Single-mode (APC)	Green	-	559517-2

Note: UPC - Ultra Physical Contact, APC - Angled Polish Connector

Snap-In Adapter Plates

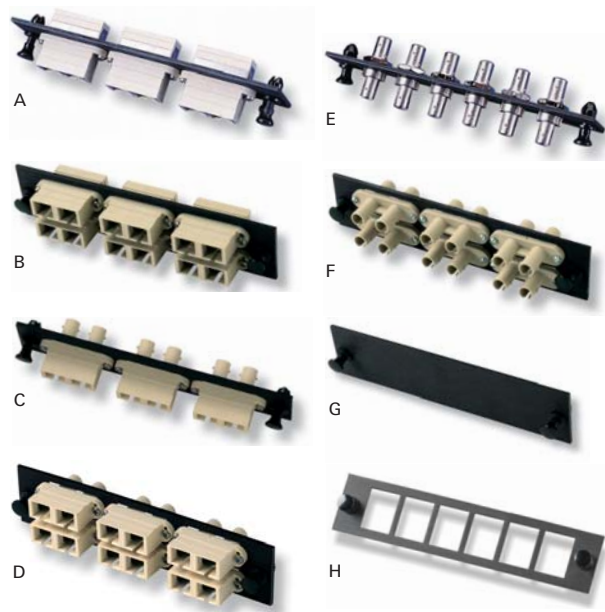

Product Facts

- All Snap-in Adapter Plates fit AMP NETCONNECT unloaded Optical Fiber Enclosures included in this chapter
- SL Series Discrete Adapter Plates accept SL Series Jacks (see Chapter 2.2) and Multimedia Inserts (see Chapters 1.2 & 2.2)
- Package quantity = 1 per pack

2.5

Adapter Description	Fibers	Type	Adapter Color	Figure	Part Number
SC Duplex	6	Multimode (62.5/125,OM1)	Beige	A	559558-1
		Multimode (50/125,OM2)	Black	-	559558-5
		Multimode (XG LO 50/125,OM3)	Aqua	-	559558-6
		Single-mode (UPC)	Blue	-	559558-2
		Single-mode (APC)	Green	-	559558-7
SC Duplex	12	Multimode (62.5/125,OM1)	Beige	B	559596-1
		Multimode (50/125,OM2)	Black	-	559596-5
		Multimode (XG LO 50/125,OM3)	Aqua	-	559596-6
		Single-mode (UPC)	Blue	-	559596-2
		Single-mode (APC)	Green	-	559596-3
SC to ST Duplex	6	Multimode (62.5/125,OM1)	Beige	C	559601-1
		Multimode (50/125,OM2)	Black	-	559601-4
		Multimode (XG LO 50/125,OM3)	Aqua	-	559601-5
		Single-mode (UPC)	Blue	-	559601-6
SC to ST Duplex	12	Multimode (62.5/125,OM1)	Beige	D	1278368-1
		Multimode (50/125,OM2)	Black	-	1278368-2
		Multimode (XG LO 50/125,OM3)	Aqua	-	1278368-3
		Single-mode (UPC)	Blue	-	1278368-5
ST Simplex	6	-	Metallic	E	559557-1
		Single-mode (UPC)	Metallic	E	559515-2
ST Duplex	12	Multimode (62.5/125,OM1)	Beige	F	1278567-1
		Single-mode (UPC)	Blue	-	1278567-2
MPO 6 Port	-	-	Black	-	1374598-1
Blank	-	-	-	G	559523-1
SL 6 Port	-	-	-	H	1479508-1

Note: UPC - Ultra Physical Contact, APC - Angled Polish Connector

Fiber Optic Rack Mount Patch Panels

2.5

1U Rack Mount Fiber Optic Patch Panel
PART NUMBER 1777125-1



Product Facts

- Accepts three (3) Snap-in Adapter Plates or MPO Cassettes (see this Chapter and 2.4, not included)
- Fits standard TIA 19" rack
- 1U (1.75")

Fiber Densities

Insert Type	Fiber Density (max)	Duplex Port Density (max)
6-Fiber Adapter Plates	18	9
12-Fiber Adapter Plates or MPO Cassettes	36	18
24-Fiber Adapter Plates or MPO Cassettes	72	36



Panel Holds 3 Snap-in Adapter Plates or MPO Cassettes (not included)

2U Rack Mount Fiber Optic Patch Panel
PART NUMBER 1435847-1



Product Facts

- Rack Mount Panel holds 72 SL Series Fiber Inserts (see Chapter 2.2, not included)
- SL Series Inserts not included with Panel (see Chapter 1.2)
- Fits standard TIA 19" rack
- Integrated front (3") and rear (8") cable management trays
- 2U (3.5")

Fiber Densities

SL Series Insert (not included with panel)	Fiber Density (max)	Duplex Port Density (max)
MT-RJ Jack Housing, 2 Fiber	144	72
LC Coupler, 2 Fiber	144	72
ST Coupler, 1 Fiber	72	36



Panel Holds 72 SL Series Fiber Inserts (not included)

122

1U Rack Mount Patch Enclosures



Description	Height	Width	Part Number
Standard Cables	1U (1.75")	19"	1348876-4
Armored and Multiple Trunk Cables	1U (1.75")	19"	1435555-1

Fiber Densities

Insert Type	Fiber Density (max)	Duplex Port Density (max)
6-Fiber Adapter Plates	18	9
12-Fiber Adapter Plates or MPO Cassettes	36	18
24-Fiber Adapter Plates or MPO Cassettes	72	36

Product Facts

- Accept three (3) Snap-in Adapter Plates or MPO Cassettes (see this Chapter and 2.4, not included)
- Enclosure 1348876-4 holds two FOSC 500 AA splice trays
 - P/N: 3-1201266-4 (not included)
 - Each tray holds 24 Fibers
- Quick release Slide and tilt drawer
- Forward, flush or recessed mounting
- Fit standard TIA 19" rack
- Include fiber management rings
- Standard Cable Enclosure includes cable strain relief
- Armored and Multiple Trunk Cables Enclosure includes:
 - Special design to hold armored or multiple trunk cables in place
 - Large rear cable entry with tie down brackets that can be mounted inside or outside of Enclosure

2.5

1U Rack Mount Patch Enclosure



Description	Height	Width	Part Number
Panel Enclosure	1U (1.75")	19"	1-1657014-7

Fiber Densities

Insert Type	Fiber Density (max)	Duplex Port Density (max)
6-Fiber Adapter Plates	18	9
12-Fiber Adapter Plates or MPO Cassettes	36	18
24-Fiber Adapter Plates or MPO Cassettes	72	36
Splice Trays (2)	48	24

Product Facts

- Accept three (3) Snap-in Adapter Plates or MPO Cassettes (see this Chapter and 2.4, not included)
- Heavy duty, smoothly operating, slide mounting brackets
- Clear top removable cover
- Flush mount
- Holds 2 Splice trays (not included)
 - P/N: 1435574-1
- Fits standard TIA 19" rack



Panel Holds 3 Snap-in Adapter Plates or MPO Cassettes (not included)

123

Loaded Enclosures

2.5

1U MT-RJ Rack Mount Patch Enclosure

PART NUMBER 1206704-4



Fiber Densities

Insert Type	Fiber Density (max)	Duplex Port Density (max)
2-Fiber MT-RJ Jacks	48	24

Product Facts

- 1U 48-Fiber Rack Mount Enclosure high-density solution
- Loaded with housings for MT-RJ Patch Panel Jacks
- Holds up to twenty-four (standard or secure) MT-RJ Patch Panel Jacks or MT-RJ Pigtail Jack Cable Assemblies (each purchased separately, see Chapter 2.3)
- Quick release Slide and tilt drawer
- Cable strain relief and management rings included
- Forward, flush or recessed mounting
- Fits standard TIA 19" rack
- Accepts icons for identification (see Chapter 8)

1U LC, SC, and ST Rack Mount Patch Enclosures



Product Facts

- Enclosures pre-loaded with LC, SC, or ST Adapters
- Quick release Slide and tilt drawer
- Cable strain relief and management rings included
- Forward, flush or recessed mounting
- Fits standard TIA 19" rack
- Enclosure 1348876-4 holds two FOSC 500 AA splice trays
 - P/N: 3-1201266-4 (not included)
 - Each tray holds 24 Fibers

Description			Coupler Color	Fiber Density	Duplex Port Density	Part Number
ST	Simplex	Multimode	Metallic	12	6	2-1206114-4
				24	12	4-1206114-4
SC	Duplex	Multimode	Beige	12	6	2-1206138-4
				24	12	4-1206138-4
		Single-mode	Blue	12	6	2-1348960-4
				24	12	4-1348960-4
LC	Duplex	Multimode	Beige	24	12	2-1671000-8
				48	24	4-1671000-8
		Single-mode	Blue	24	12	2-1671000-4
				48	24	4-1671000-4

2U Rack Mount Patch Enclosures



Description	Height	Width	Part Number
Standard Cables	2U (3.50")	19" or 23"	559542-2
Armored and Multiple Trunk Cables	2U (3.50")	19" or 23"	1435556-1

Fiber Densities

Insert Type	Fiber Density (max)	Duplex Port Density (max)
6-Fiber Adapter Plates	24	12
12-Fiber Adapter Plates or MPO Cassettes	48	24
24-Fiber Adapter Plates or MPO Cassettes	96	48

Product Facts

- Accept up to four (4) Snap-in Adapter Plates or MPO Cassettes (see this Chapter and 2.4, not included)
- Removable front and rear covers for easy access and installation
- Front and rear fiber/cable management rings
- Edge guard on front cable entries for cable assembly protection
- Forward, flush or recessed mounting
- Fits standard TIA 19" and 23" racks
- Standard Cable Enclosure includes cable strain relief
- Armored and Multiple Trunk Cable Enclosure includes:
 - Special design to hold armored or multiple trunk cables in place
 - Large rear cable entry with tie down brackets that can be mounted inside or outside of Enclosure
- Shown loaded with 6-Fiber Duplex SC Snap-in Adapter Plates (not included)

2.5

3U Rack Mount Patch Enclosures and Accessories



Standard Front



Back

Description	Height	Width	Part Number
Standard Cables	3U (5.25")	19" or 23"	559614-2
Armored and Multiple Trunk Cables	3U (5.25")	19" or 23"	1435557-1
3U Security Kit	-	-	1435187-2

Fiber Densities

Insert Type	Fiber Density (max)	Duplex Port Density (max)
6-Fiber Adapter Plates	48	24
12-Fiber Adapter Plates or MPO Cassettes	96	48
24-Fiber Adapter Plates or MPO Cassettes	192	96

Product Facts

- Accept up to eight (8) Snap-in Adapter Plates or MPO Cassettes (see this Chapter and 2.4, not included)
- Removable front and rear covers for easy access and installation
- Front and rear cable management rings
- Edge guard on front cable entries for cable assembly protection
- Forward, flush or recessed mounting
- Fits standard TIA 19" and 23" racks
- Standard Cable Enclosure includes cable strain relief
- Armored and Multiple Trunk Cable Enclosure includes:
 - Special design to hold armored or multiple trunk cables in place
 - Large rear cable entry with tie down brackets that can be mounted inside or outside of Enclosure
- Security Kit includes two (2) locks and one (1) aluminum front door (black)
 - For use with 3U enclosure 559614-2 only
- Shown loaded with 12-Fiber MT-RJ Snap-in Adapter Plates (not included)

125

Unloaded Enclosures and Accessories

2.5

4U Rack Mount Patch Enclosures and Accessories



Description	Height	Width	Part Number
Standard Cables	4U (7.0")	19" or 23"	559552-2
Armored and Multiple Trunk Cables	4U (7.0")	19" or 23"	1435558-1
4U Security Kit	-	-	*1435161-2

Fiber Densities

Insert Type	Fiber Density (max)	Duplex Port Density (max)
6-Fiber Adapter Plates	72	36
12-Fiber Adapter Plates or MPO Cassettes	144	72
24-Fiber Adapter Plates or MPO Cassettes	288	144

Product Facts

- Accept twelve (12) Snap-in Adapter Plates or MPO Cassettes (see this Chapter and 2.4, not included)
- Removable front and rear covers for easy access and installation
- Front and rear cable management rings
- Edge guard on front cable entries for cable assembly protection
- Forward, flush or recessed mounting
- Fits standard TIA 19" and 23" racks
- Standard Cable Enclosure includes cable strain relief
- Armored and Multiple Trunk Cable Enclosure includes:
 - Special design to hold armored or multiple trunk cables in place
 - Large rear cable entry with tie down brackets that can be mounted inside or outside of Enclosure
- Security Kit includes two (2) locks and one (1) aluminum front door (black)
 - *For use with 4U enclosure 559552-2 only
- Shown loaded with 6-Fiber ST Snap-in Adapter Plates (not included)

Rack Mount Fiber Management Enclosures and Accessories

PART NUMBER 1435808-1



Front, Extended

Product Facts

- Holds excess loops of fiber cable or patch cords
- Drawer style
- Cable Management loops included
- 2U (3.50")

Accessories for Rack Mount Enclosures

Description	Cable Diameter	Figure	Part Number
Cable Strain Relief	3.5 - 8mm	A	1206144-1
	9 - 14mm	B	1206145-1
Cable Management Ring Kit	-	C	1206146-1



126

Rack Mount Splice Enclosures

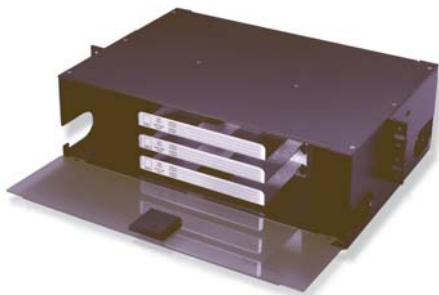

Description		Part Number
3U	3 Splice Tray Holders	559089-2
4U	4 Splice Tray Holders	1435990-2

Fiber Density/Splice Tray Capacity

Insert Type	Fiber Count (max)	Splice Tray Holder Capacity(splice trays)
3U Fiber Density	72	6
4U Fiber Density	96	8

Product Facts

- Each splice tray holder accepts two (2) splice trays
 - 1435839 or 559433 splice trays (not included)
- Splice tray holders are located in front of unit allowing cable storage in rear
- Removable rear and clear front covers for easy access and installation
- Clear front cover
- Edge guard on front cable entry for cable assembly protection
- Fits standard TIA 19" and 23" racks

Splice Trays and Accessories for 3U and 4U Rack Mount Splice Enclosures

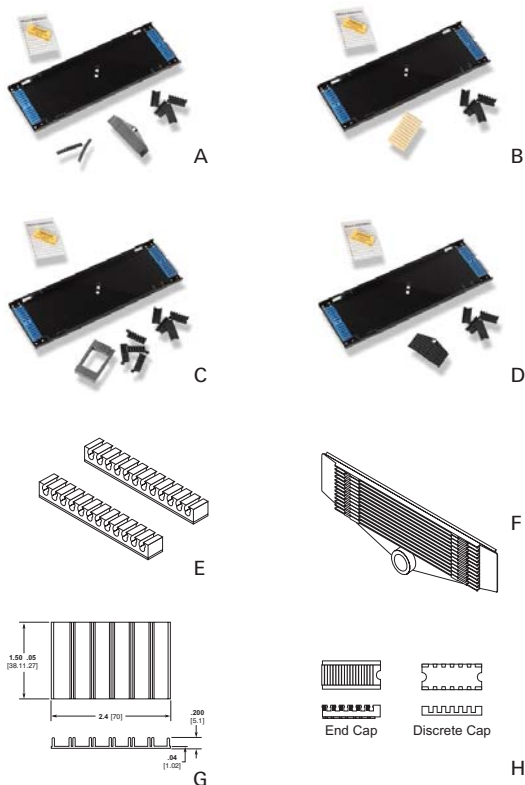

Product Facts

- Hold up to 12 splices each
- Used with 2U, 3U, and 4U Rack Mount Splice Enclosures
- Accommodates both through (in-line) and end (butt) splice configurations
- Black anodized aluminum construction for durability and clear plastic top for improved fiber visibility
- Each splice tray includes clear plastic cover, end caps for fiber retention, and splice holders as listed
- Splice and Fiber Holders are also available separately
- 559433 splice tray holders found in Chapter 2.6

Splice Trays with Splice Holders

Description	Included Splice Holder	Figure	Part Number
Splice Tray	Fusion with sleeve & Elastomeric	A	1435839-1
	CORELINK	B	1435839-2
	Universal	C	1435839-3
	Mechanical	D	1435839-4

Splice and Fiber Holders

Description	Figure	Part Number
Splice Holder	Fusion with sleeve & Elastomeric	E
	Fusion	F
	CORELINK	G
Fiber Holder	H	559532-1

Splice and Patch Enclosure

2.5

Rack Mount Splice and Patch Enclosures, 2U (3.50-inch)

PART NUMBER 1435652-1



Back, Open



Front, Open with Tray Extended

Fiber Density/Splice Tray Capacity

Insert Type	Fiber Count (max)	Splice Tray Holder Capacity (splice trays)
6-Fiber Adapter Plates	18	9
12-Fiber Adapter Plates or MPO Cassettes	36	18
24-Fiber Adapter Plates or MPO Cassettes	72	36
Spliced Fiber Capacity	72	–
Splice Tray Holder Capacity	6	–

Product Facts

- Accepts:
 - Up to three (3) Snap-in Adapter Plates or MPO Cassettes (see this Chapter and 2.4, not included)
 - Up to six (6) 559433 splice trays (see splice accessories table below)
- Removable front and rear covers for easy access and installation
- Front and rear cable management rings
- Edge guard on front cable entries for cable assembly protection
- Forward, flush or recessed mounting
- Fits standard TIA 19" and 23" racks
- Specially designed to hold armored or multiple trunk cables in place
- Large side or rear cable entry features tie down brackets that can be mounted inside or outside of enclosure
- A splicing shelf is located over adapter plates
- Designed as a drawer for easy access

Splice Accessories for Rack Mount Splice and Patch Enclosure

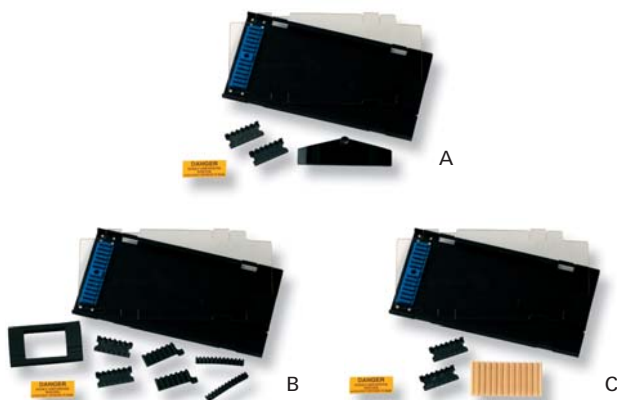

Product Facts

- Can mix and match splice trays
- Splice trays hold up to 12 fusion, elastomeric, or mechanical splices (select appropriate part number)
 - CORELINK mechanical splices in Chapter 2.2
- Black anodized aluminum construction for durability and improved fiber visibility
- Each splice tray includes clear plastic cover, end caps for fiber retention, and appropriate splice holders

Description	Included Splice Holder	Figure	Part Number
Splice Tray	Fusion	A	559433-2
	Elastomeric & Fusion with Sleeve	B	559433-3
	CORELINK	C	559433-4

128

WALL MOUNT ENCLOSURES & ACCESSORIES

Unloaded Wall Mount Enclosures 130
 Unloaded Wall Mount Patch Enclosures 131
 Unloaded Wall Mount Splice and Patch Enclosures 132
 Splice Trays and Accessories 132
 Loaded Wall Mount Patch Enclosures 133
 Loaded Wall Mount Splice and Patch Enclosures 133

2.6

Chapter Summary

- Wall mount enclosures provide options for remote placement and protection of fiber terminations
- Complete line of connectivity, splice and size options - up to 96 fibers
- Hold the AMP NETCONNECT product line of Snap-in Adapter Plates and MPO Cassettes
- Mix and match snap-in adapter plates to accommodate multiple connector types
- Loaded enclosures include pre-mounted SC Duplex or ST Adapters
- Rack mount enclosures

2.6

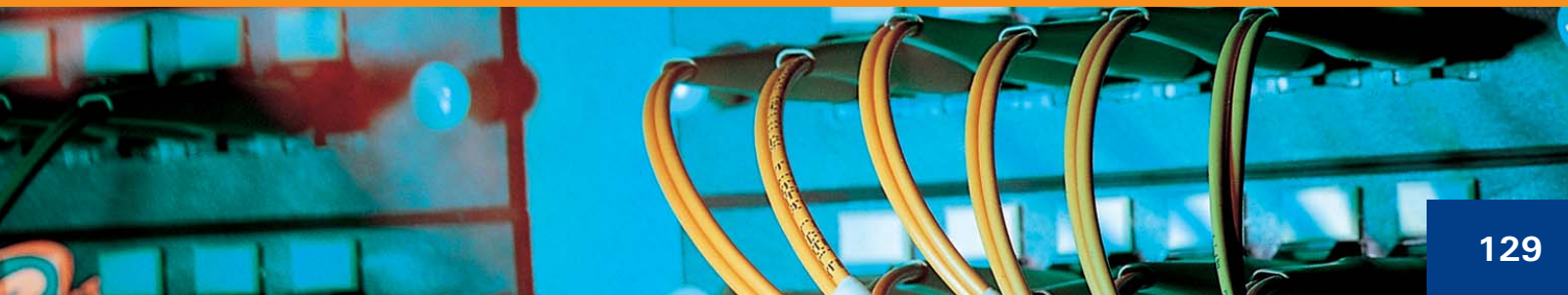

129

Unloaded Enclosures & Accessories

2.6

Single Sided, Single Door Wall Mount Patch Enclosure



Description	Part Number
Double Adapter Plate Wall Mount Patch Enclosure	1278323-2
Optional Lock	559501-2
Replacement Cable Grommets	559496-2

Fiber Densities

Insert Type	Fiber Density (max)	Duplex Port Density (max)
6-Fiber Adapter Plates	12	6
12-Fiber Adapter Plates or MPO Cassettes	24	12
24-Fiber Adapter Plates or MPO Cassettes	48	24

Product Facts

- Accepts two snap-in adapter plates or MPO Cassettes (see this Chapter and 2.4, not included)
- Top and bottom cable entries feature integral rubber cable grommets
- Reversible cable strain relief bracket
- Internal cable management
- Fiber loop storage and management
- Recessed, easy-to-use door latch
- Optional lock package for added security
- Designed for use in protected areas
 - Allows access to adapter ports even when door closed
- Nominal dimensions: 8" (20cm) H x 4" (10cm) D x 8" (20cm) W

Double Sided, Double Door Wall Mount Patch Enclosure

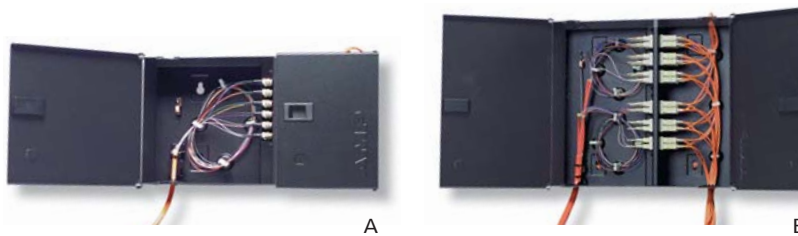

Description	Adapter Plate Capacity		Part Number
	Figure	Figure	
Double Sided, Double Door Wall Mount Enclosures	2	A	559560-2
	4	B	559561-2
	4	-	559561-3
Optional Lock			559501-2
Replacement Cable Grommets			559496-2

Fiber Densities

Insert Type	Two Adapter Plate		Four Adapter Plate	
	Fiber Count (max)	Duplex Port Density (max)	Fiber Count (max)	Duplex Port Density (max)
6-Fiber Adapter Plates	12	6	24	12
12-Fiber Adapter Plates or MPO Cassettes	24	12	48	24
24-Fiber Adapter Plates or MPO Cassettes	48	24	96	48

Product Facts

- Accepts two or four snap-in adapter plates or MPO Cassettes (see this Chapter and 2.4, not included)
- Top and bottom cable entries feature integral rubber cable grommets
- Reversible cable strain relief bracket
- Internal cable management
- Fiber loop storage and management
- Recessed, easy-to-use door latches
- Optional lock package for added security
- Designed for indoor use
- Doors prevent access to adapter ports when closed
- Nominal dimensions: 13.5" (38cm) H x 4" (10cm) D x 15" (34cm) W

130

Double Sided, Single Door Wall Mount Patch Enclosure

PART NUMBER 1435128-1



Fiber Densities

Insert Type	Fiber Density (max)	Duplex Port Density (max)
6-Fiber Adapter Plates	24	12
12-Fiber Adapter Plates or MPO Cassettes	48	24
24-Fiber Adapter Plates or MPO Cassettes	96	48

Product Facts

- Accepts up to four snap-in adapter plates or two MPO Cassettes (see this Chapter and 2.4, not included)
 - MPO Cassettes in top two slots only
- Top and bottom cable entries feature integral rubber cable grommets
- Integral hasp for use with off-the-shelf padlocks
- Recessed, easy-to-use door latch
- Designed for indoor use
- Door prevents access to adapter ports when closed
- Nominal dimensions: 12" (30.5cm) H x 3" (7.6cm) D x 12" (30.5cm) W

2.6

Wall/Furniture Mounting Bracket

PART NUMBER 1777126-1



Shown with optional cable ring

Product Facts

- Accepts up to two snap-in adapter plates or two MPO Cassettes (see this Chapter and 2.4, not included)
- Optional Cable Management Ring
P/N: 1206146-1
- Mounting holes for fastening to TIA rack, wall, or furniture
- Bracket Color: Black
- Compatible with magnetic means

Fiber Densities

Insert Type	Fiber Density (max)	Duplex Port Density (max)
6-Fiber Adapter Plates	12	6
12-Fiber Adapter Plates or MPO Cassettes	24	12
24-Fiber Adapter Plates or MPO Cassettes	48	24

131

Unloaded Enclosures & Accessories

2.6

Double Sided, Double Door Wall Mount Splice and Patch Enclosures



Description	Part Number
Double Sided, Double Door Wall Mount Patch and Splice Enclosures	1278755-1
with Cable Grommets and Cable Glands	1278755-3
with Grommets, Cable Glands and one Splice Tray Holder (1374526)	1278755-4
Optional Lock	559501-2
Replacement Cable Grommets	559496-2

Fiber Densities/Fiber Splice Capacity

Insert Type	Fiber Count (max)	Duplex Port Density (max)
6-Fiber Adapter Plates	36	18
12-Fiber Adapter Plates or MPO Cassettes	72	36
24-Fiber Adapter Plates or MPO Cassettes	144	72
Spliced Fiber Capacity	48	-

Product Facts

- Accepts up to six snap-in adapter plates or MPO Cassettes (see this Chapter and 2.4, not included)
- Top and bottom cable entries feature integral rubber cable grommets as listed
- Reversible cable strain relief bracket
- Can hold one splice holder (1374526, below)
 - Splice holder can hold up to four splice trays (listed below)
- Recessed, easy-to-use door latches
- Optional lock package for added security
- Designed for indoor use
- Doors prevent access to adapter ports when closed
- Knockout ports for cable glands or grommets
- Nominal dimensions: 16.5" (40cm) H x 14" (35.5cm) D x 5" (13cm) W

Splice Accessories for Wall Mount Splice and Patch Enclosure

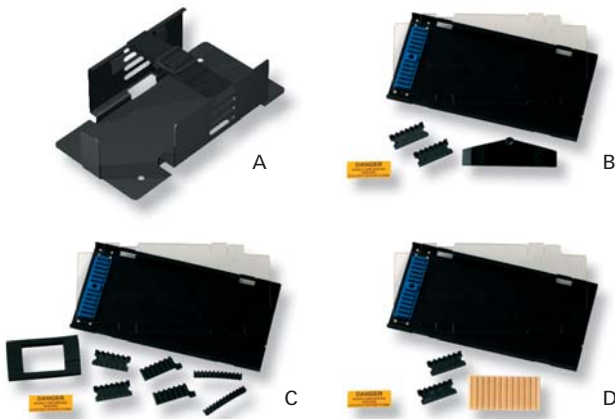

Description	Included Splice Holder	Figure	Part Number
Splice Tray Holder	-	A	1374526-1
Splice Tray	Fusion	B	559433-2
	Elastomeric & Fusion with Sleeve	C	559433-3
	CORELINK	D	559433-4

Product Facts

- Splice tray holder can hold up to four splice trays
 - Can mix and match splice trays
- Splice trays hold up to 12 fusion, elastomeric or mechanical splices (select appropriate part number)
 - CORELINK mechanical splices in Chapter 2.2
- Black anodized aluminum construction for durability and improved fiber visibility
- Each splice tray includes clear plastic cover, end caps for fiber retention, and appropriate splice holders

132

Double Sided, Single Door Wall Mount Patch Enclosure



Product Facts

- Pre-loaded with Multimode ST or SC Duplex Adapters
- Integral hasp for use with off-the-shelf padlocks
- Recessed, easy-to-use door latches
- Designed for indoor use
- Door prevents access to adapter ports when closed
- Recessed, easy-to-use door latch
- Nominal dimensions: 12" (30 cm) H x 3" (77cm) D x 12" (30 cm) W

Description		Coupler Color	Fiber Density	Duplex Port Density	Part Number
ST	Multimode	Beige	12	6	1435129-1
			24	12	1435129-2
SC Duplex	Multimode	Beige	12	6	1435130-1
			24	12	1435130-2

Double Sided, Single Door Wall Mount Splice and Patch Enclosure



Product Facts

- Pre-loaded with SC Duplex Adapters as listed
- Top and bottom, left and right cable entries feature plastic grommets
- Includes cable management rings
- Includes one splice holder and one splice tray
 - Splice tray can hold up to twelve splices
- Integral hasp for use with off-the-shelf padlocks
- Designed for indoor use
- Door prevents access to adapter ports when closed
- Recessed, easy-to-use door latch
- Nominal dimensions: 12" (30.5cm) H x 3" (7.6cm) D x 12" (30.5cm) W

Description		Coupler Color	Fiber Density	Duplex Port Density	Part Number
SC Duplex	Multimode	Beige	12	6	1435467-3
			12	6	1435467-4
	Single-mode	Blue	6	3	1435467-1
			2	1	1435467-2

Notes

2.6

134

OPTICAL FIBER TOOLS & ACCESSORIES

No-epoxy/No-polish Termination Tool Kits 137-138
 LightCrimp PLUS Cable Holders/Cleave Tools 139
 No-epoxy/Polish Termination Tools Kits 140
 Epoxy/Polish Termination Tool Kits 141
 Epoxy/Polish LC Termination Accessories 142
 Epoxies 142
 Epoxy Applicator Syringe 143
 Polishing Consumables 143
 Epoxy Curing Oven 143
 Inspection Microscope and Accessories 144
 Optical Fiber Termination Accessories 145
 AMP CORELINK Splice Workstation 145
 Polishing Bushings, Curing Sleeves and Strip Template Kit 145
 PRO-CRIMPER III Hand Tool and Optical Fiber Die Set 146
 Optical Fiber Cleaning Accessories 147

Chapter Summary

- Tools come in convenient kits optimized for each connector technology
 - No-epoxy/No-polish
 - No-epoxy/Polish
 - Epoxy/Polish
- Epoxies, polishing film, polishing bushings (“pucks”) and other consumables
- Crimp tools, cleavers, strippers and microscopes
- Curing ovens
- Most tools can also be purchased separately
- Cleaning accessories

2.7



Tool Kit Compatibility Chart

	Part Number	MT-RJ Jacks	MT-RJ SECURE Jacks	LightCrimp PLUS			LightCrimp		Epoxy/Polish		
				**LC	SC	ST	SC	ST	LC	SC	ST
Deluxe Premises Termination Tool Kit	1278949-2	X	X	X	X	X	X	X	-	-	-
Deluxe Premises Termination Tool Kit	1278949-3	X	X	X	X	X	X	X	-	-	-
MT-RJ Jack Tool Kit	1278346-1	X	X	-	-	-	-	-	-	-	-
MT-RJ Jack Tool Kit	1278346-2	X	X	-	-	-	-	-	-	-	-
LightCrimp PLUS No-epoxy/No-polish Universal Tool Kit	1278118-4	X	X	X	X	X	-	-	-	-	-
LightCrimp PLUS No-epoxy/No-polish Universal Tool Kit	1278118-5	X	X	X	X	X	-	-	-	-	-
LightCrimp PLUS No-epoxy/No-polish LC Tool Kit	1754845-1	-	-	X	-	-	-	-	-	-	-
LightCrimp PLUS No-epoxy/No-polish LC Tool Kit	1754845-2	-	-	X	-	-	-	-	-	-	-
LightCrimp PLUS No-epoxy/No-polish SC Tool Kit	1278022-1	-	-	-	X	-	-	-	-	-	-
LightCrimp PLUS No-epoxy/No-polish SC Tool Kit	1278022-2	-	-	-	X	-	-	-	-	-	-
LightCrimp PLUS No-epoxy/No-polish ST Tool Kit	492697-1	-	-	-	-	X	-	-	-	-	-
LightCrimp PLUS No-epoxy/No-polish ST Tool Kit	492697-2	-	-	-	-	X	-	-	-	-	-
LightCrimp SC/ST No-epoxy/Polish Tool Kits	503957-1	-	-	-	-	-	X	X	-	-	-
	503957-3	-	-	-	-	-	X	X	-	-	-
	492543-1	-	-	-	-	-	X	X	-	-	-
LightCrimp SC No-epoxy/Polish Tool Kits	503706-1	-	-	-	-	-	X	-	-	-	-
	503706-2	-	-	-	-	-	X	-	-	-	-
LightCrimp ST No-Epoxy/Polish Tool Kits	503330-1	-	-	-	-	-	-	X	-	-	-
	503330-3	-	-	-	-	-	-	X	-	-	-
	492322-1	-	-	-	-	-	-	X	-	-	-
Pro-installer Epoxy/Polish Tool Kits	501258-7	-	-	-	-	-	-	-	X*	X	X
	501258-8	-	-	-	-	-	-	-	X*	X	X
	501258-9	-	-	-	-	-	-	-	X*	X	X
Epoxy/Polish Tool Kits	503746-7	-	-	-	-	-	-	-	X*	X	-
	503746-1	-	-	-	-	-	-	-	X*	-	X

*Note: Termination of LC Epoxy/Polish Connectors requires additional tools listed in this chapter.

**Note: Termination includes LC SECURE Connectors

Epoxy/Polish Connector Consumables/Compatibility Chart

	Epoxies			Polishing Films					Consumable Package*
	EPO-TEK 504035-1	TRA-CON 1918652-1	HYSOL 502418-1	9 µm 1374484-1	5 µm 228433-8	Diamond Film 503887-1	0.3 µm 228433-5	Final Polishing Film 502748-2	
LC Single-mode	X	X	X	X	X	X	X	-	502306-4
LC Multimode	X	X	X	X	X	X	X	-	502306-4
SC Single-mode	X	X	X	-	X	-	X	X	502306-2
SC Multimode	X	X	X	-	X	-	X	X	502306-2
ST Single-mode	-	X	X	-	X	-	X	X	502306-2
ST Multimode	-	X	X	-	X	-	X	-	502306-1

*Note: Epoxy & film for ~ 100 connectors.

No-epoxy/No-polish Termination Tools Kits

2.7

Deluxe Premises Termination Tool Kit



Product Facts

- Includes all tools need for installing popular field-installable connectors
 - MT-RJ and MT-RJ SECURE Jacks
 - LightCrimp PLUS SC, LC, LC SECURE and ST connectors
 - LightCrimp SC and ST connectors
- Convenient carrying case
- Includes consumables for LightCrimp connector terminations
 - For additional LightCrimp connector terminations, order additional polishing films 228433-9, 228433-8, 228433-7 and 228433-5
- See this chapter for cleave tool descriptions

Description	Part Number
No-epoxy/No-polish Termination Tool Kit with cleave tool (492674-1), no microscope	1278949-2
No-epoxy/No-polish Termination Tool Kit with cleave tool (1871696-1) and inspection microscope	1278949-3

MT-RJ Jack Termination Tool Kit



Product Facts

- Includes all tools needed for installing MT-RJ and MT-RJ SECURE Jacks
- See this chapter for cleave tool descriptions

Description	Figure	Part Number
MT-RJ Termination Tool Kit with cleave tool (492674-1), no microscope	A	1278346-1
MT-RJ Termination Tool Kit with cleave tool (1871696-1) and inspection microscope	-	1278346-2

LightCrimp PLUS Termination Tool Kits

Description	Part Number
Universal LightCrimp PLUS No-epoxy/No-polish Tool Kit (SC, LC and ST) with cleave tool (492674-1), no microscope	1278118-4
Universal LightCrimp PLUS No-epoxy/No-polish Tool Kit (SC, LC and ST) with cleave tool (1871696-1) and inspection microscope	1278118-5
LightCrimp PLUS LC Connector Termination Tool Kit with cleave tool (492674-1), no microscope	1754845-1
LightCrimp PLUS LC Connector Termination Tool Kit with cleave tool (1871696-1) and inspection microscope	1754845-2
LightCrimp PLUS SC Connector Termination Tool Kit with cleave tool (492674-1), no microscope	1278022-1
LightCrimp PLUS SC Connector Termination Tool Kit with cleave tool (1871696-1) and inspection microscope	1278022-2
LightCrimp PLUS ST Connector Termination Tool Kit with cleave tool (492674-1), no microscope	492697-1
LightCrimp PLUS ST Connector Termination Tool Kit with cleave tool (1871696-1) and inspection microscope	492697-2

Product Facts

- Universal kits Include all tools needed for installing all LightCrimp PLUS no-epoxy/no-polish connectors, MT-RJ, and MT-RJ SECURE Jacks
- Convenient carrying case
- See this chapter for cleave tool descriptions



137

No-epoxy/No-polish Termination Tools Kits

2.7

No-epoxy/No-polish Upgrade and Adaptive Termination Tool Kits

Product Facts

- Upgrade Tool Kit supplements existing LightCrimp PLUS Tool Kits with tools needed to install LC connectors
- Adaptive Tool Kits supplements existing fiber optic tool kits with the tools needed to terminate LightCrimp PLUS connectors
- Saves money on full tool kit by reusing tools from currently owned tool kits

Description	Terminates	Includes	Cost Savings	Part Number
LC LightCrimp PLUS Upgrade Kit	LightCrimp PLUS LC	LC Die Set and Cable Holder	Low Cost Upgrade for Current Tool Kit	1754847-2
LC LightCrimp PLUS Adaptive Kit	LightCrimp PLUS LC	Crimp Tool, LC Die Set, LC Cable Holder, Cleave Tool (492674-1), Instruction Sheet	Fiber and Cable Strippers in Current Tool Kit	1754846-1
LC LightCrimp PLUS Adaptive Kit	LightCrimp PLUS LC	Crimp Tool, LC Die Set, LC Cable Holder, Cleave Tool (1871696-1), Inspection Microscope, Instruction Sheet		1754846-2
SC LightCrimp PLUS Adaptive Kit	LightCrimp PLUS SC	Crimp Tool, SC Die Set, SC Cable Holder, Cleave Tool (492674-1), Instruction Sheet	Fiber and Cable Strippers in Current Tool Kit	1754737-1
SC LightCrimp PLUS Adaptive Kit	LightCrimp PLUS SC	Crimp Tool, SC Die Set, SC Cable Holder, Cleave Tool (1871696-1), Inspection Microscope, Instruction Sheet		1754737-2
Combination LightCrimp PLUS Adaptive Kit	LightCrimp PLUS SC and ST	Crimp Tool, SC and ST Die Sets, SC and ST Cable Holders, Cleave Tool (492674-1), Instruction Sheets	Fiber and Cable Strippers in Current Tool Kit	1754739-1
Combination LightCrimp PLUS Adaptive Kit	LightCrimp PLUS SC and ST	Crimp Tool, SC and ST Die Sets, SC and ST Cable Holders, Cleave Tool (1871696-1), Inspection Microscope, Instruction Sheets		1754739-2
ST LightCrimp PLUS Adaptive Kit	LightCrimp PLUS ST	Crimp Tool, ST Die Set, ST Cable Holder, Cleave Tool (492674-1), Instruction Sheet	Fiber and Cable Strippers in Current Tool Kit	1754738-1
ST LightCrimp PLUS Adaptive Kit	LightCrimp PLUS ST	Crimp Tool, ST Die Set, ST Cable Holder, Cleave Tool (1871696-1), Inspection Microscope, Instruction Sheet		1754738-2

No-epoxy/No-polish Termination Tools

LightCrimp PLUS Cable Holders

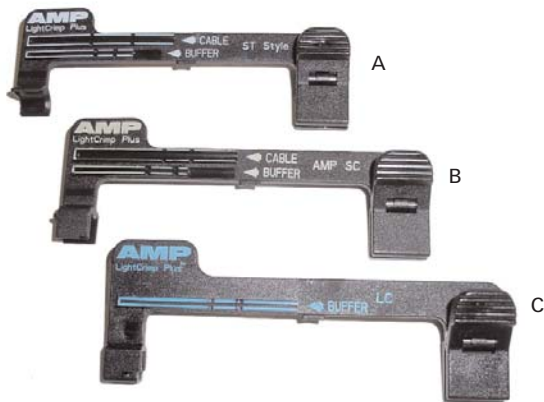

Product Facts

- Used in LightCrimp PLUS connector terminations (included in LightCrimp PLUS Tool Kits)

2.7

Description	Figure	Part Number
ST	A	492703-1
SC	B	1278023-1
LC	C	1754138-1

Fiber Optic Cleave Tool

PART NUMBER 492674-1



Product Facts

- Cleave fibers for LightCrimp PLUS connectors, MT-RJ and MT-RJ SECURE Jacks
- Included in most tool kits for MT-RJ Jacks and LightCrimp PLUS connectors (not included with LC Upgrade Kit)
- Easy to use: clamp, score and bend
- Blade life-span is ~ 1000 cleaves

Hand Held Cleaver

PART NUMBER 1871696-1



Product Facts

- Cleave fibers for LightCrimp PLUS connectors, and MT-RJ Jacks
- Operator independent
- Cleave lengths of 4mm, 6mm, and 8mm
- Blade life-span more than 10,000 cleaves
- Cleave surface angle <1.5 degrees
- No fracture, roll-off, or lid cleaves

139

No-epoxy/Polish Termination Tool Kits

2.7

LightCrimp Termination Tool Kits



Product Facts

- Includes all tools needed for installing the listed type LightCrimp no-epoxy/polish connectors
- Convenient carrying case
- Includes consumables for installing 60 LightCrimp connectors
- For additional LightCrimp terminations, order additional polishing films 228433-9, 228433-8, 228433-7 and 238433-5 (this Chapter)
- Note: photo is representative of kits – contents may vary by part number

Description		Microscope (if listed)	Part Number
LightCrimp SC	Termination Kit	–	503706-1
		Premium Microscope	503706-2
LightCrimp ST	Termination Kit	–	503330-1
		Premium Microscope	503330-3
	Mini Tool Kit	–	492322-1
LightCrimp SC and ST	Termination Kit	–	503957-1
		Premium Microscope	503957-2
	Mini Tool Kit	–	492543-1

LightCrimp Cleave Tool

PART NUMBER 503705-1



Product Facts

- Used in both SC and ST LightCrimp Connector terminations
- Included in the Deluxe and LightCrimp Tool Kits

Epoxy/Polish Termination Tool Kits

2.7

Pro-Installer Epoxy/Polish Connector Termination Tool Kits



Professional Installer Kit

Description	Part Number
With 110 V Curing Oven and Microscope	501258-7
With 220 V Curing Oven and Microscope	501258-8
Without Curing Oven or Microscope	501258-9

Product Facts

- Includes all tools necessary to install SC, ST, and FC Connectors
 - For LC terminations, also order parts listed in the Epoxy/Polish LC Terminations Accessories page (this Chapter)
- Tool kits include:
 - PRO-CRIMPER III Hand Tool and crimping dies
 - Polishing bushings
 - Polishing film (also sold separately, this chapter)
 - Fiber strippers
 - Scribe tool
- Includes polishing films to install 60 epoxy/polish connectors
 - Epoxy is sold separately (this Chapter)
- Kits available with curing oven and microscope or without
- Convenient carrying case
- Photo is representative of kits – contents vary by part number

Epoxy/Polish Connector Termination Tool Kits



Description	Part Number
SC	503746-7
ST	503746-1

Product Facts

- Includes all tools necessary to install the listed epoxy/polish connectors
 - For LC terminations, also order parts listed in the Epoxy/Polish LC Terminations Accessories page (this Chapter)
- Tool kits include:
 - PRO-CRIMPER III Hand Tool and crimping dies
 - Polishing bushings
 - Polishing film (also sold separately, this chapter)
 - Fiber strippers
 - Scribe tool
- Includes polishing films to install ~ 60 epoxy/polish connectors
 - Epoxy is sold separately (this Chapter)
- Does not include curing oven or microscope
- Convenient carrying case

141

Epoxy/Polish Termination Accessories and Epoxies

2.7

Epoxy/Polish LC Termination Accessories

Description	Part Number
LC Polishing Puck- metal	1754074-1
LC Polishing Puck- polymer	1918196-1
LC Cable Preparation Template	1588756-1
LC Hand Tool and Die Set	1588176-1
LC 1.25mm Ferrule Microscope Adapter	1278997-1
LC Oven Block Assembly	1457628-1
LC Adaptive Kit - Anaerobic adhesive style	1754603-1
LC Adaptive Kit - Heat cure	1754462-1

Product Facts

- Supplement epoxy/polish tool kits (this Chapter) with these components to terminate LC Epoxy/Polish Connectors
- One of each of the first three components is required
- Different polishing films are required for LC polishing (see table and films in this Chapter)
- In addition to the Epoxy/Polish tool kits on the previous page, these items are needed to terminate LC Epoxy/Polish Connectors

EPO-TEK 353ND Epoxy
PART NUMBER 504035-1



Product Facts

- For use with SC and LC Connectors
- Pre-measured two-part packets for consistent results
- Long pot life once mixed
- Heat-cured epoxy
- Supplied in 4-gram packets
- Cures in 15 minutes at 115° C
- Epoxy curing time starts after the oven has restabilized to the desired temperature after inserting the connectors into the curing block

TRA-CON Epoxy
PART NUMBER 1918652-1



Product Facts

- For use with SC, LC and ST Connectors
- Pre-measured two-part packets for consistent results
- Can be heat-cured or cured at ambient temperature
- Supplied in 2-gram packets
- Each packet terminates ~ 250 connectors
- 25 packets per pack
- Pot life = 30 minutes
- Cures in:
 - 24 hours @ 25°C
 - 2 hours @ 65°C
 - 10 minutes @ 110°C
- Epoxy curing time starts after the oven has restabilized to the desired temperature after inserting the connectors into the curing block

HYSOL Epoxy-Tubes
PART NUMBER 502418-1



Product Facts

- For use with SC, LC and ST Connectors
- Two-part epoxy in two tubes
- Heat-cured epoxy
- Terminates ~ 400 connectors
- One set of two (2) tubes per part number
- Pot life = 30 minutes
- Cures in 30 minutes at 100°C
- Epoxy curing time starts after the oven has restabilized to the desired temperature after inserting the connectors into the curing block

142

Epoxy Applicator Syringe

PART NUMBER 501473-3



Product Facts

- 3 cc capacity

2.7

Polishing Films

Description	Grit Grade	Part Number	
Hand Polishing Film	Packet of 100	15 μm	228433-9
	Packet of 15	9 μm	1374484-1
	Packet of 100	5 μm	228433-8
	Packet of 100	1 μm	228433-7
	Packet of 5	Diamond	503887-1
Final Polishing Film	Packet of 100	0.3 μm	228433-5
	Packet of 5	Final	502748-2
Consumables Kit	Multimode ST	-	502306-1
	SC, Single-mode ST	-	502306-2
	LC	-	502306-4

Product Facts

- Polishing films used to install LightCrimp and Epoxy/Polish Connectors
- See listing of correct films by connector type (this Chapter)
- Consumable kits include all consumables needed to install ~ 100 of the listed Epoxy/Polish connectors

Epoxy Curing Oven



Description	Part Number
110 VAC	502134-1
220 VAC	502134-2
Adapter Block for 8 Duplex Connectors	502222-1
Adapter Block for 24 Single Connectors	502129-1
LC Oven Block Assembly	1457628-1

Product Facts

- Reduces time required to cure epoxy
- Provides a uniform, controlled curing environment
- Used for all AMP NETCONNECT Optical Fiber epoxy/polish connectors
- Comes equipped to cure up to four Duplex Connectors and 12 Simplex Connectors at once
 - Optional blocks reconfigure to 8 Duplex or 24 Simplex Connectors
- Variable temperature control (60°C to 125°C)
- Includes thermometer - Epoxy curing time starts after the oven has restabilized to the desired temperature after inserting the connectors into the curing block
- Includes cable support bracket
- Two voltage options
- Curing sleeves (this Chapter)

143

Inspection Microscope



Product Facts

- Optimal visual examination of terminated ends
 - 500 μm field of view
- Dual illumination
 - Coaxial for inspecting polish quality
 - Oblique for general conditions
- Pre-centered, threaded adapter mount provides easy focusing and changing of connectors
- Field and laboratory examination for multimode and single-mode fibers
- Portable
- Integral infrared filter for safety
 - Do NOT use any microscope to view active fiber signals
- Disposable, Type LR44 batteries
- Long-life LED (approximately 100,000 hours of operation)
- Each Kit includes:
 - 10-power objective microscope with an impact resistant ergonomic rubber shell and high quality glass optics
 - 20-power eyepiece
 - Padded carrying case with an integrated belt loop and internal adapter storage pocket
 - Neck lanyard with safety breakaway feature
 - Universal 2.5mm ferrule adapter (for SC, ST and FC)

Description		Part Number
Inspection Microscope		1754767-1
	1.25 mm Universal LC and MU	1754765-1
	2.5 mm Universal SC, ST and FC	1754766-1
	MT-RJ	1754768-1
	SC APC	1828833-1
Adapters	MPX	1828834-1
	MPX APC	1828835-1
	MPO	1828836-1
	MPO APC	1828837-1
	FSMA	1985040-1
	Required FSMA coupling adapter	1985041-1

DANGER: Active fibers should never be viewed through a microscope.

Sapphire-Tipped Scribe Tool and Accessories



Description	Part Number
Sapphire-tipped Scribe Tool	504064-1
Replacement Blades	504290-1

Product Facts

- Long-lasting sapphire blade
- Pen-type casing
- Used to install all AMP NETCONNECT Epoxy/Polish Connectors
- Included in Epoxy/Polish Tool Kits

2.7

CORELINK Splice Workstation PART NUMBER 503605-1



Product Facts

- Optional tool for installing CORELINK mechanical splices (Chapter 2.2)
- Convenient fiber and splice holder for easy installation
- Works with single-mode and multimode CORELINK mechanical splices

Polishing Bushings, Curing Sleeves, and Strip Card Kit

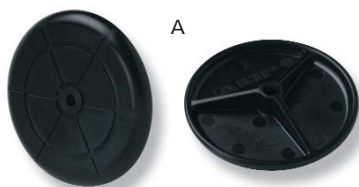

Polishing Bushing 2.5mm

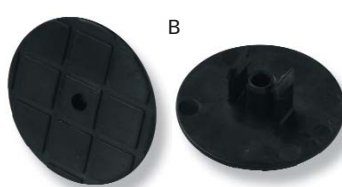

Polishing Bushing SC



ST Curing Sleeve,
2.5mm Bayonet

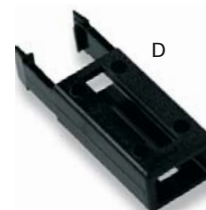

SC Curing Sleeve

Product Facts

- Polishing bushings included in many tool kits
- Curing sleeves hold connectors in oven

Description	Cable Jacket Diameter (mm)	Used With	Notes	Figure	Part Number
LC Fiber Protectors, for Buffered Fiber		Epoxy/Polish LC Connectors	–	–	1457630-1
LC Fiber Protectors, for Jacketed Cable		Epoxy/Polish LC Connectors	–	–	1457630-2
Polish Bushing	3.0	Ceramic and Stainless Steel ST Connectors	Metal	–	503337-1
		Ceramic, Stainless Steel and Polymer Composite ST Connectors	Black Polymer	A	503304-1
	–	SC Connectors	Black Polymer	B	502631-1
	–	LC Connectors	Metal	–	1754074-1
Curing Sleeve	3.0	Ceramic, Stainless Steel and Polymer Composite ST Connectors	12 pieces	C	502259-1
		SC Connectors	1 piece	D	502656-1
Strip Template Kit	–	SC and ST Connectors	–	–	501818-1

145

Termination and Cleaning Accessories

2.7

PRO-CRIMPER III Hand Tool and Optical Fiber Die Sets



PRO-CRIMPER III Hand Tool
(shown with a die set)

Product Facts

- Crimp tools included in many tool kits
- Crimp tools and dies used with LightCrimp and Epoxy/Polish Connectors
- Die sets are interchangeable in the crimp tool

For Use With	Cable Jacket Diameter (mm)	Part Number		
		Hand Tool Only	Die Set Only	Hand Tool w/Die Set
PRO-CRIMPER III Hand Tool	-	58532-1	-	-
SC (Polymer Crimp Body)	3.0	58532-1	503910-1	503911-1
	2.4 & 3.0	58532-1	492025-1	492026-1
SC (Metal Crimp Body)	1.6 - 2.0, 2.4	58532-1	1588175-1	1588176-1
	3.0	58532-1	492131-1	-
LC	1.6 - 2.0, 2.4, 3.0	58532-1	1588175-1	1588176-1
ST, Ceramic	3.0	58532-1	58424-1	58433-4
ST, Stainless Steel	3.0	58532-1	58424-1	58433-4
ST, Stainless Steel (504000-X Series Only)	3.0	58532-1	58552-1	58551-1
ST Ceramic Used with Loose Tube	3.8	58532-1	503890-1	-
LightCrimp PLUS LC	1.6 - 2.0	58532-2	1754136-1	1754137-1
LightCrimp PLUS and LightCrimp SC	3.0	58532-2	492783-1	492782-1
LightCrimp PLUS and LightCrimp ST	3.0	58532-2	492622-1	492623-1

MTP/MPO IBC (In Bulkhead Cleaner)

PART NUMBER 1918809-1



Product Facts

- Dry cloth cleaner utilizes densely woven micro-fiber cloth
- Cleans male (with pins) or female MTP/MPO connectors in adapters, bulkheads, and faceplates
- Pre-washed cleaning cloth is lint and debris free
- Each cleaner is capable of more than 400 cleanings
- Protective dust cover doubles as an adapter cap for cleaning unmated connectors
- FOCIS 5-Type MTP/MPO interface compliant
- Removes dust and oil contamination

146

OPTIPOP R Reel Optical Connector Cleaner



Product Facts

- Densely woven micro-fiber cloth cleans fiber optic connector tips while reducing static charge
- Variety of reel cleaner configurations allow for use on the major connector types including FC, SC, ST, LC, MT-RJ, and MPO

2.7

Description	Part Number
MPO w/pins Reel Cleaner	1918802-1
One slot Reel Cleaner; 1.25mm, 2.5mm, MT no pins	1918803-1
MT-RJ plug w/pins Reel Cleaner	1918804-1
Two slot Reel Cleaner; 1.25mm and 2.5mm	1918805-1
Reel Cleaner refill (6 per pack)	1918806-1

OPTIPOP C Card Optical Connector Cleaner



Product Facts

- Densely woven micro-fiber cloth cleans fiber optic connector tips while reducing static charge
- For use on the major connector types including FC, SC, ST, LC, MT-RJ, and MPO
- Captures debris and other contamination
- Cloth dimensions: 120mm [4.72 in] x 57mm [2.24 in]

Description	Part Number
Fiber Connector Card Cleaner	1918810-1
Card Cleaner Refill (10 per pack)	1918811-1

NEOCLEAN Stick Cleaner



Product Facts

- Dry cloth stick cleaners utilize a densely woven micro-fiber cloth to clean fiber optic connector tips while reducing static charge
- Perforated handle for customizing length and angle
- Overall stick length: 151mm [5.94 in]
- 10 Sticks per package

Description	Part Number
Stick Cleaner - 2.5mm Tip Diameter	1918807-1
Stick Cleaner - 1.25mm Tip Diameter	1918808-1

147

OUTLETS, FACEPLATES, AND ACCESSORIES

SL Series Faceplates and Modules	152-153
Standard, Angled, and Flush Faceplates	154-157
HIDEOUT Outlets	158
HIDEAWAY Multimedia Outlets	159-160
SL Series Inserts	161-165
SL Series and 110Connect Modular Jacks	166
Multimedia Security Outlet	167
Surface Mount Outlet and Office Boxes	168-170
AMP COMMUNICATIONS OUTLET (ACO)	171-182
Faceplates for Wiremold Raceways	183
Access Floor Workstation Modules (AFWM)	184-187
Desktop Monuments	188
Modular Furniture Faceplate Kits	189-192
Multi-User Outlets (MUO)	193-194

3

CONSOLIDATION POINTS & ACCESSORIES

Consolidation Points for Drop Ceiling Systems	195
Consolidation Points for Raised Floor Systems	196
Modular Consolidation Points and Accessories	197-199

Chapter Summary

- Outlet styles to meet every need
- SL Series provides high density and front-loadable modularity
- Faceplates are available in plastic and stainless steel, angled and straight
- HIDEAWAY and HIDEOUT outlets excel in fiber interoperability
- The AMP Communications Outlet (ACO) is uniquely suited for Sheath-sharing applications
- Access Floor Workstation Modules accommodate raised flooring
- Outlets for modular furniture and raceway applications
- Zone cabling helps realize long-term cost benefits on moves, adds and changes
- Fully compliant with TIA/EIA-568-B.2

3



149

Outlets, Faceplates, and Accessories Information

Faceplate/Outlet, Jack and Insert Twisted Pair Compatibility List

		SL Series Unshielded Modular Jacks	SL Series Shielded Modular Jacks	SL Series AMP-TWIST Modular Jack	SL Series Multimedia Jacks	SL Series Multimedia Inserts	SL Series Multimedia Modules	SL Series Modules	110Connect Unshielded Modular Jacks	110Connect Shielded Modular Jacks
SL Series Modules	1116409	X	X	X	X	X	-	-	X	-
	1116406	X	X	X	X	X	-	-	X	-
	1116408	X	X	-	X	X	-	-	-	-
SL Series Faceplates	1339118	-	-	-	-	-	X	X	-	-
	1339119	-	-	-	-	-	X	X	-	-
	1479486	-	-	-	-	-	X	X	-	-
Standard Faceplates	557505	X	X	X	X	X	-	-	X	X
	557502	X	X	X	X	X	-	-	X	X
	558088	X	X	X	X	X	-	-	X	X
	83935	X	X	X	X	X	-	-	X	X
	557691	X	X	X	X	X	-	-	X	X
	83936	X	X	X	X	X	-	-	X	X
	558086	X	X	X	X	X	-	-	X	X
Angled Faceplates	1375155	X	X	X	X	X	-	-	X	X
	406185	X	X	X	X	X	-	-	X	X
Flush Faceplates	1479152	X	X	X	X	X	-	-	X	X
	1479443	X	X	X	X	X	-	-	X	X
	1479444	X	X	X	X	X	-	-	X	X
	1479445	X	X	X	X	X	-	-	X	X
	1479446	X	X	X	X	X	-	-	X	X
Stainless Steel Faceplates from Semtron	1479447	X	X	X	X	X	-	-	X	X
	1FM-ØE-AMP-PHONE	X	X	X	X	-	-	-	X	X
	1FM-ØE-AMP	X	X	X	X	-	-	-	X	X
	1FM-(4)ØE-AMP	X	X	X	X	-	-	-	X	X
	1FM-(6)ØE-AMP	X	X	X	X	-	-	-	X	X
	1FM-ØE-AMP-LAB	X	X	X	X	-	-	-	X	X
	1FM-ØE-AMP-LAB	X	X	X	X	-	-	-	X	X
	1FM-(3)ØE-AMP-LAB	X	X	X	X	-	-	-	X	X
	1FM-(4)ØE-AMP-LAB	X	X	X	X	-	-	-	X	X
	1FM-(6)ØE-AMP-LAB	X	X	X	X	-	-	-	X	X
	2FM-DØE-AMP	X	X	X	X	-	-	-	X	X
	2FM-D(4)ØE-AMP	X	X	X	X	-	-	-	X	X
	2FM-D(6)ØE-AMP	X	X	X	X	-	-	-	X	X
2FM-(6)ØE-AMP-LAB	X	X	X	X	-	-	-	X	X	
2FM-(12)ØE-AMP-LAB	X	X	X	X	-	-	-	X	X	
Mounting Straps	1116618	X	X	X	X	X	-	-	X	-
	1339120	X	-	X	X	X	-	-	-	-
	1479784	X	X	X	X	X	-	-	X	-
	1116616	X	X	X	X	X	-	-	X	-
	1479504	X	X	X	X	X	-	-	-	-
HIDEOUT Outlet	503999	X	-	-	X	X	-	-	X	-
	503997	X	-	-	X	X	-	-	X	-
	503998	X	-	-	X	X	-	-	X	-
HIDEAWAY Multimedia Outlets	1479815	X	-	-	X	X	-	-	-	-
	1479946	X	X	X	X	X	-	-	-	-
Multimedia Security Outlet	1116535	X	X	X	X	X	-	-	X	X
Universal Office Boxes	1479488	X	X	-	X	-	-	-	X	X
	1479489	X	X	-	X	-	-	-	X	X
	1479490	X	X	-	X	-	-	-	X	X
12-Port Universal Office Box	1479358	X	X	X	X	X	-	-	X	X
Modular Jack Boxes	1116697	X	-	-	-	-	-	-	X	-
	1116698	X	-	-	-	-	-	-	X	-
WIREMOLD Raceway Faceplates	1375050	X	X	X	X	X	-	-	X	X
	1375049	X	X	X	X	X	-	-	-	-
WIREMOLD 2A Inserts	CM2-U2AMP-XX	X	X	X	X	-	-	-	-	-
AFWM Flush Faceplates	569916	X	X	-	X	-	-	-	X	-
	569917	X	X	-	X	-	-	-	X	X
	1116695	X	X	-	X	-	-	-	X	X
FLEX-MODE Modular Furniture Faceplates Kits	1375288	X	X	-	X	X	-	-	-	-
	558106	X	X	X	X	X	-	-	X	X
	558107	X	X	X	X	X	-	-	X	X
SL Series Furniture Outlets	1375005	X	-	-	X	X	-	-	-	-
	1375006	X	-	-	X	X	-	-	-	-
Flush Faceplate for Herman Miller Furniture	558357	X	X	X	X	X	-	-	X	-
Standard Faceplates for Herman Miller Furniture	569127	X	X	X	X	-	-	-	X	-
	558191	X	X	X	X	-	-	-	X	-

Outlets, Faceplates, and Accessories Information

Faceplate/Outlet, Jack and Insert Optical Fiber Compatibility List

	Part Number	Jacks and Inserts				
		SL Series MT-RJ and MT-RJ SECURE Outlet Jacks	SL Series Multimedia Inserts - Single ST	SL Series Multimedia Inserts - LC Duplex	SL Series Multimedia Modules SC Duplex, Dual ST	Duplex Couplers (SC and ST) and Parallel Dress Clips
SL Series Modules	1116409	X	X	X	-	-
	1116406	X	X	X	-	X
	1116408	X	X	X	-	-
SL Series Faceplates	1339118	-	-	-	X	-
	1339119	-	-	-	X	-
	1479486	-	-	-	X	-
Standard Faceplates	557505	X	X	X	-	-
	557502	X	X	X	-	-
	558088	X	X	X	-	-
	83935	X	X	X	-	-
	557691	X	X	X	-	-
	83936	X	X	X	-	-
Angled Faceplates	558086	X	X	X	-	-
	1375155	X	X	X	-	-
	406185	X	X	X	-	-
Flush Faceplates	1479152	X	X	X	-	-
	1479443	X	X	X	-	-
	1479444	X	X	X	-	-
	1479445	X	X	X	-	-
	1479446	X	X	X	-	-
	1479447	X	X	X	-	-
Stainless Steel Faceplates from Semtron	1FM-ØE-AMP-PHONE	X	X	X	-	-
	1FM-ØE-AMP	X	X	X	-	-
	1FM-(4)ØE-AMP	X	X	X	-	-
	1FM-(6)ØE-AMP	X	X	X	-	-
	1FM-ØE-AMP-LAB	X	X	X	-	-
	1FM-ØE-AMP-LAB	X	X	X	-	-
	1FM-(3)ØE-AMP-LAB	X	X	X	-	-
	1FM-(4)ØE-AMP-LAB	X	X	X	-	-
	1FM-(6)ØE-AMP-LAB	X	X	X	-	-
	2FM-DØE-AMP	X	X	X	-	-
	2FM-D(4)ØE-AMP	X	X	X	-	-
	2FM-D(6)ØE-AMP	X	X	X	-	-
Mounting Straps	2FM-(6)ØE-AMP-LAB	X	X	X	-	-
	2FM-(12)ØE-AMP-LAB	X	X	X	-	-
	1116618	X	X	X	-	-
	1339120	X	X	X	-	-
	1479784	X	X	X	-	-
	1116616	X	X	X	-	-
HIDEOUT Outlet	1479504	X	X	X	-	-
	503999	X	X	X	-	X
	503997	X	X	X	-	X
HIDEAWAY Multimedia Outlets	503998	X	X	X	-	X
	1479815	X	X	X	-	X
Multimedia Security Outlet	1479946	X	X	X	-	X
	1116535	X	X	X	-	X
Surface Mount Outlet Accessories	1116098	X	X	X	-	-
	557775	X	X	X	-	-
12-Port Universal Office Box	1116111	-	-	-	-	X
	1479358	X	X	X	-	-
WIREMOLD Raceway Faceplates	1375050	X	X	X	-	-
	1375049	X	X	X	-	-
WIREMOLD 2A Inserts	CM2-U2AMP-XX	X	X	X	-	-
	569646	-	-	-	-	X
	569648	-	-	-	-	X
AFWM Flush Faceplates	569916	X	-	X	-	-
	569917	X	-	X	-	-
	1116695	X	-	X	-	-
FLEX-MODE Modular Furniture Faceplates Kits	1375288	X	X	X	-	-
	558106	X	X	X	-	-
	558107	X	X	X	-	-
SL Series Furniture Outlets	1375005	X	X	X	-	-
	1375006	X	X	X	-	-
Flush Faceplate for Herman Miller Furniture	558357	X	X	X	-	-
Standard Faceplates for Herman Miller Furniture	569127	X	X	X	-	-
	558191	X	X	X	-	-

3

151

AMP, AMP NETCONNECT, FLEX-MODE, HIDEAWAY, HIDEOUT, MT-RJ SECURE, NETCONNECT, TE Logo and Tyco Electronics are trademarks. Herman Miller is a trademark of Herman Miller, Inc. Semtron is a trademark of Semtron, Inc. WIREMOLD is a trademark of The Wiremold Company.

SL Series Faceplates

3

SL Series Faceplates

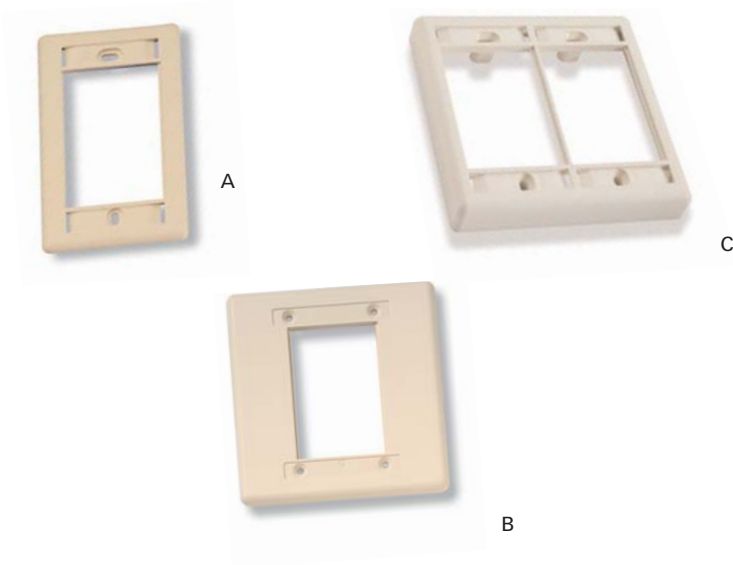

Product Facts

- Single gang and double gang, single-sided faceplates accept three 1 Unit or two 1.5 Unit SL Series Modules
- Double gang, double-sided faceplates accept three 1 Unit or two 1.5 Unit SL Series Modules on each side
- Front-loading modules eliminate need to remove faceplates from wall for changes or repairs
- Double gang, double-sided SL Series faceplates:
 - Dimensions: 0.675" D x 4.490" W x 4.540" H
 - For use with openings a minimum of 2.81" x 3.59" (not suitable for mud rings/device covers)

Description	Figure	Part Number
Faceplate Single Gang	A	1339118-X
Faceplate Double Gang	Single-Sided	B
	Double-Sided	C

X denotes color: -1 = Almond, -2 = Black, -3 = White, -4 = Gray, 1--1 = Electrical Ivory

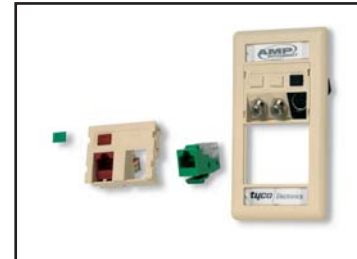

SL Series Modules

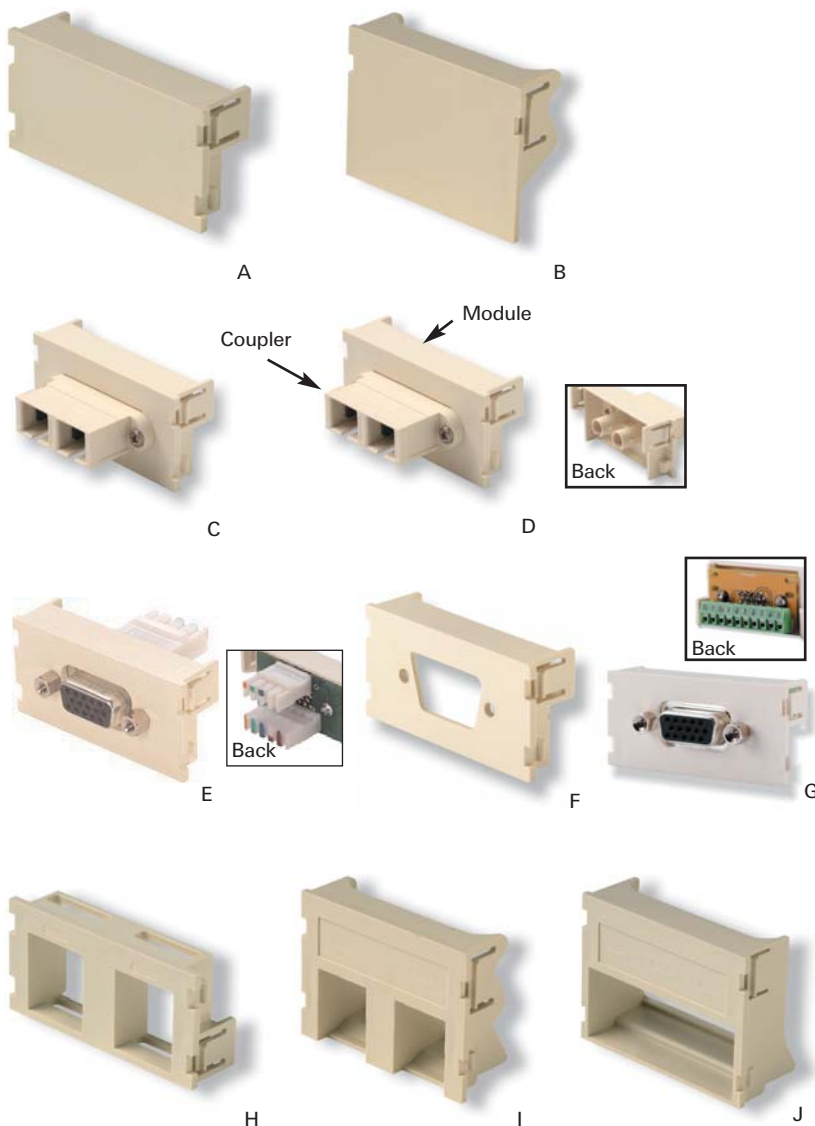

Product Facts

- Fit SL Series Faceplates
- Front loading
- Optical Fiber Coupler Modules are suitable for use with multimode or single-mode connectors as listed
- SVGA Multimedia Modules are available loaded with a SVGA 110 Termination Module or unloaded for use with 15 position subminiature D connectors (sold separately)
- SVGA-110 Termination Module
 - Is suitable for use with Standard Category 5e or 6 UTP or FTP (recommended) cables
 - Works with VGA and SVGA signals
 - Can be used where distances between monitor and computer do not exceed:
 - 15 ft with Cat 5e UTP cable
 - 20 ft with Cat 6 UTP cable
 - 35 ft with Cat 5e or 6 FTP cables
 - Requires a 9th conductor and is recommended for use with FTP cables (utilizes drain wire for 9th conductor)
- SVGA-Screw terminal
 - Allows field termination of SVGA cable
 - For distances up to 150 feet at a resolution of 800 x 600 using standard 5 conductor 26 AWG coaxial video cable
- 2-Port Modules are suitable for use with all SL Series and 110Connect Jacks, MT-RJ Outlet Jacks and SL Series Multimedia Inserts
- 3-Port Module is suitable for use with unshielded SL Series Jacks, MT-RJ Outlet Jacks and SL Series Multimedia Inserts
- 2- and 3-Port Modules feature patented "invisible" icon holes which stay hidden until used

Description	Units	Figure	Part Number	
Blank	1	A	1116410-X	
	1.5	B	1116407-X	
2-Fiber Coupler	Duplex SC	Single-mode, Blue Coupler	1	1375306-X
		Multimode, Beige Coupler	1	1375123-X
	Duplex SC to ST	Multimode, Beige Coupler	1	1375241-X
SVGA-110	Loaded (with SVGA-110)	1	1479288-X	
SVGA - Blank	Unloaded	1	1479079-X	
SVGA-Screw Terminal	Loaded (with SVGA-Screw Terminal)	1	1933423-X	
2-Port	Straight		1	1116409-X
		Angled	1.5	1116406-X
3-Port	Angled	1.5	1116408-X	

X denotes module color: -1 = Almond, -2 = Black, -3 = White, -4 = Gray, 1--1 = Electrical Ivory

Standard and Angled Faceplates

3

Standard Faceplates

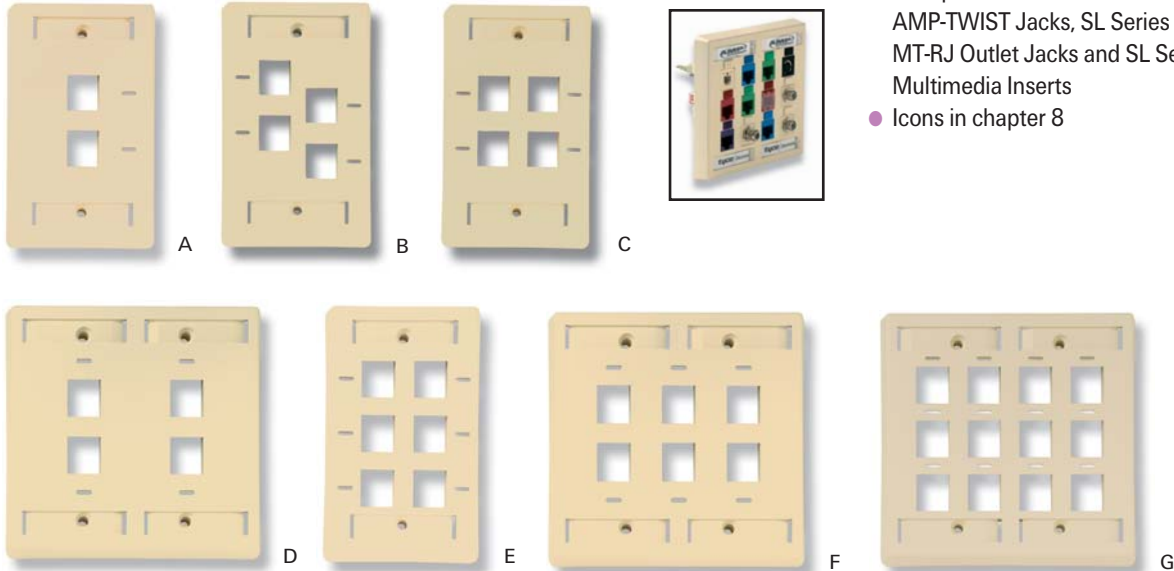

Product Facts

- Accepts all 110Connect Jacks, AMP-TWIST Jacks, SL Series Jacks, MT-RJ Outlet Jacks and SL Series Multimedia Inserts
- Icons in chapter 8

Description		Figure	Part Number	
Standard Faceplate	2-Port	Single Gang	A	557505-X
	4-Port Staggered	Single Gang	B	557502-X
	4-Port	Single Gang	C	558088-X
		Double Gang	D	83935-X
	6-Port	Single Gang	E	557691-X
		Double Gang	F	83936-X
	12-Port	Double Gang	G	558086-X

X denotes color: -1 = Almond, -2 = Black, -3 = White, -4 = Gray, 1--1 = Electrical Ivory

Angled Faceplates

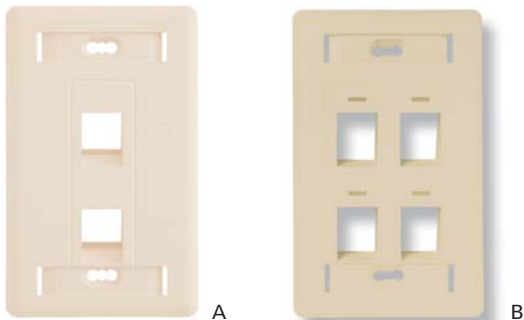

Product Facts

- Accept all 110Connect Jacks, AMP-TWIST Jacks, SL Series Jacks, MT-RJ Outlet Jacks and SL Series Multimedia Inserts
- Angled connector exits
- Protects connections
- Allows closer furniture placement
- Icons in Chapter 8



Description		Figure	Part Number
Angled Faceplate	2-Port	A	1375155-X
	4-Port	B	406185-X

X denotes color: -1 = Almond, -2 = Black, -3 = White, -4 = Gray, 1--1 = Electrical Ivory

Flush Faceplates

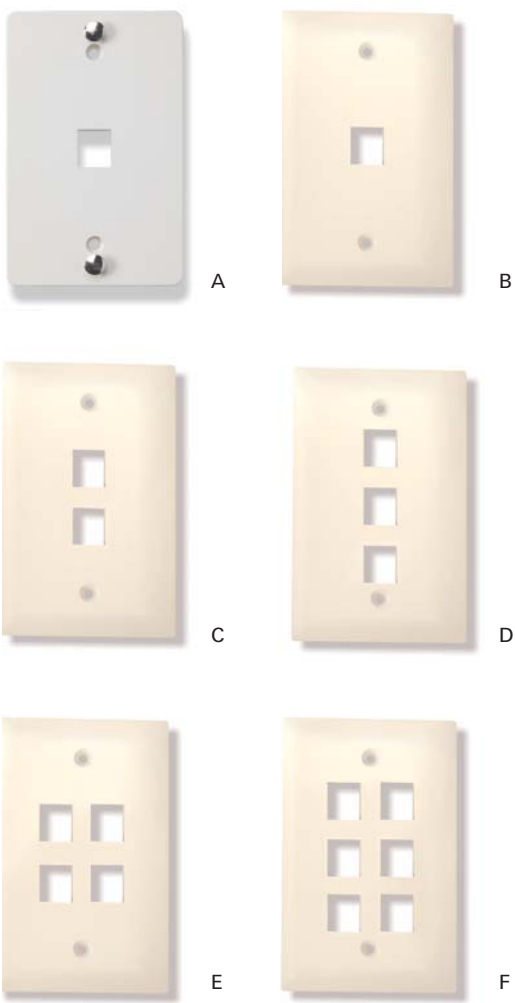

Product Facts

- Flush mount installation
- Accepts all 110Connect and SL Series Jacks, AMP-TWIST Jacks, MT-RJ Outlet Jacks, and SL Series Multimedia Inserts
- Accepts RJ45 SECURE jacks, see Chapter 4
- Mid-sized faceplate
- 1479152 is for use with 110Connect or SL Series Modular Jacks, and features studs used to mount standard wall mount telephones

Description	Figure	Part Number	
Flush Faceplate	1-Port/Phone	A	1479152-X
	1-Port	B	1479443-X
	2-Port	C	1479444-X
	3-Port	D	1479445-X
	4-Port	E	1479446-X
	6-Port	F	1479447-X

X denotes color: -1 = Almond, -2 = Black, -3 = White, -4 = Gray, 1--1 = Electrical Ivory

Stainless Steel Faceplates from Semtron

Stainless Steel Faceplates from Semtron

3

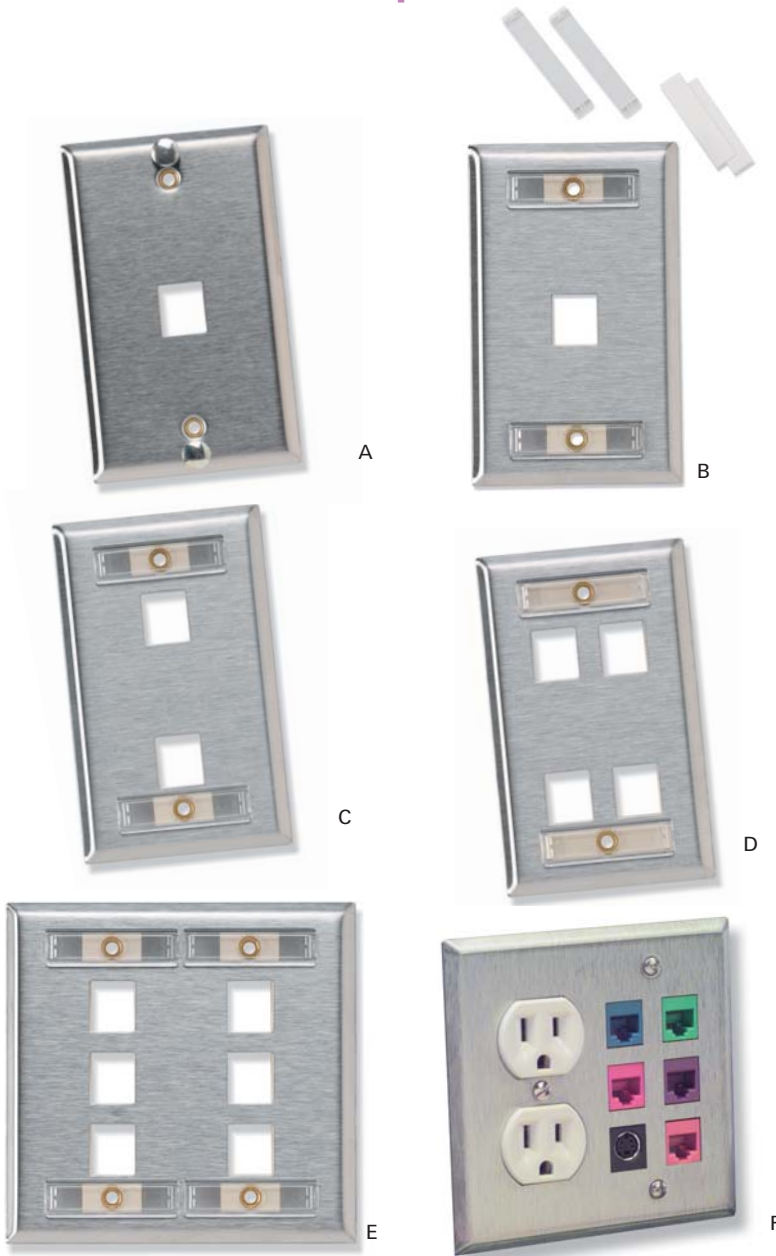

Product Facts

- Flush mount installation
- 1FM-ØE-AMP-PHONE is for use with 110Connect or SL Series Modular Jacks and features studs used to mount standard wall mount telephones
- 2-, 4- and 6-Port Faceplates accept 110Connect and SL Series Jacks, AMP-TWIST Jacks, MT-RJ Outlet Jacks, and SL Series Multimedia Inserts
- Double Gang Stainless Steel Faceplates with Power additionally accept one duplex power receptacle (sold separately)
- These faceplates are available directly from: Semtron, Inc.
6465 Corunna Rd.
Flint, MI 48532
Phone: 1-800-732-9080
Fax: 810-732-9665
Email: semtron@semtron.com
www.semtron.com

Description		Figure	Semtron Part Number
Single Gang for Wall Phone	1-Port	A	1FM-ØE-AMP-PHONE
	2-Port	-	1FM-ØØE-AMP
Single Gang	4-Port	-	1FM-(4)ØE-AMP
	6-Port	-	1FM-(6)ØE-AMP
	1-Port	B	1FM-ØE-AMP-LAB
Single Gang with Labels and Label Covers	2-Port	C	1FM-ØØE-AMP-LAB
	3-Port	-	1FM-(3)ØE-AMP-LAB
	4-Port	D	1FM-(4)ØE-AMP-LAB
	6-Port	E	1FM-(6)ØE-AMP-LAB
Double Gang	2-Port with power	F	2FM-DØØE-AMP
	4-Port with power	-	2FM-D(4)ØE-AMP
	6-Port with power	-	2FM-D(6)ØE-AMP
Double Gang with Labels and Label Covers	6-Port with power	-	2FM-(6)ØE-AMP-LAB
	12-Port with power	-	2FM-(12)ØE-AMP-LAB

HIDEOUT Outlet

HIDEOUT Outlets

3

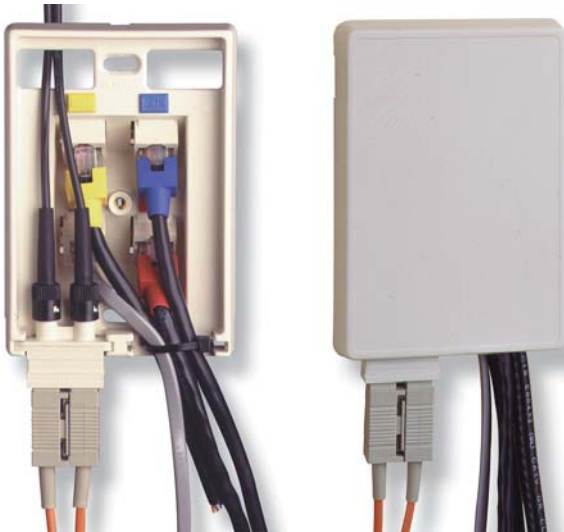

Screw-on Cover

Snap-on Cover

Product Facts

- Double gang box with single gang cover recommended.
 - May not fit all single gang boxes
- Hides and protects cable connections
- Feeds from bottom to allow flush furniture placement
- Accepts unshielded 110Connect or SL Series Modular and Multimedia Jacks, MT-RJ Outlet Jacks, duplex fiber optic adapters, MT-RJ Parallel Dress Clips, or SL Series Multimedia Inserts
- Multimedia options:
 - Four 110Connect Jacks and one MT-RJ Parallel Dress Clip (simplex or duplex) or one duplex optical fiber adapter
 - Four 110Connect or SL Series Jacks and two MT-RJ Parallel Dress Clips (simplex or duplex) or two duplex optical fiber adapters
- Match office with choice of four decorator colors or stainless steel faceplate
- Fits standard electrical boxes
- Icons in Chapter 8
- Each kit includes sub-plate, faceplate, adhesive labels, cable ties, and mounting screws. Media modules and icons must be ordered separately. Faceplates are plastic except for the stainless steel version

Description	Part Number
Snap-On Faceplate Kit	503999-X
Snap-On Faceplate Only	504641-X
Screw-On Faceplate Kit	503997-X
Stainless Steel Screw-On Faceplate Kit	503998-1
Screw-On Faceplate Only	504629-X
Stainless Steel Screw-On Faceplate Only	504643-1

X denotes color: -1 = Almond, -2 = Black, -3 = White, -4 = Gray

HIDEAWAY Multimedia Outlets

HIDEAWAY Multimedia Outlets

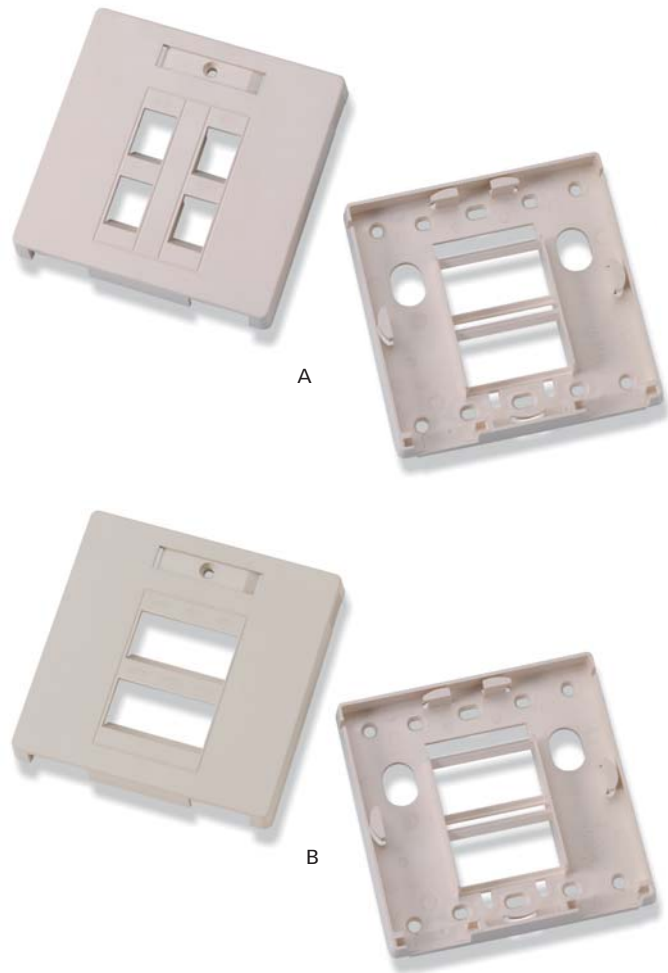

Product Facts

- Accepts unshielded SL Series Jacks, MT-RJ Outlet Jacks, and SL Series Multimedia Inserts
- Accepts two duplex Optical Fiber Couplers or MT-RJ Parallel Dress Clips (see this Chapter)
- Fit Single and Double Gang Electrical J-Boxes
- Feature patented "invisible" icon holes which remain hidden until used
- Feature integral tabs for easy fiber loop management
- 4-Port HIDEAWAY will accept SL Series Shielded Jacks and AMP-TWIST Jacks

3

Description		Figure	Part Number
Double Gang	4-Port	A	1479946-X
	6-Port	B	1479815-X

X denotes color: -1 = Almond, -2 = Black, -3 = White, -4 = Gray, 1--1 = Electrical Ivory

HIDEAWAY Outlet Accessories

HIDEAWAY Multimedia Outlet Accessories

3

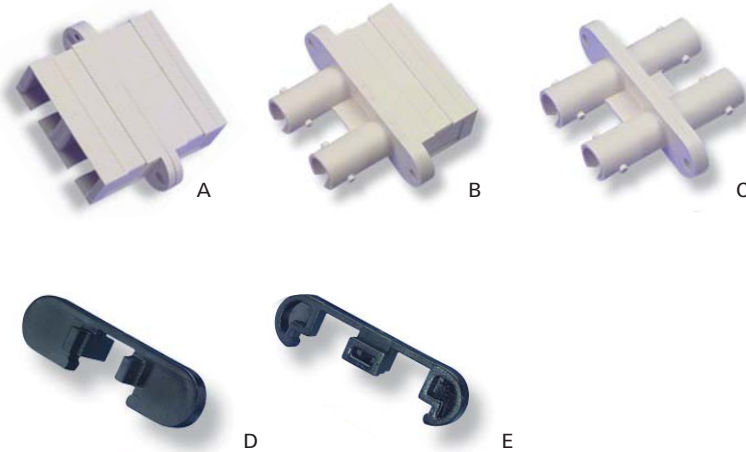

Product Facts

- 1-Port MT-RJ Parallel Dress Clip holds one MT-RJ Jack sold separately (see Chapter 2.2)
- 2-Port MT-RJ Parallel Dress Clip holds two MT-RJ Jacks sold separately (see Chapter 2.2)
- Optical Fiber Couplers are suitable for use with Multimode Connectors
- Other Optical Fiber Couplers available (see Chapter 2.2)

Description		Figure	Part Number
Duplex Optical Fiber Adapters	Multimode	Duplex SC	A 5504640-3
		Duplex SC to ST	B 5504663-1
		Duplex ST	C 504662-1
MT-RJ Parallel Dress Clips for HIDEAWAY Outlets	Pkg of 6	1-Port	D 1374206-1
	Pkg of 3	2-Port	E 1374205-1

SL Series Inserts and Multimedia Jacks

SL Series Multimedia Inserts

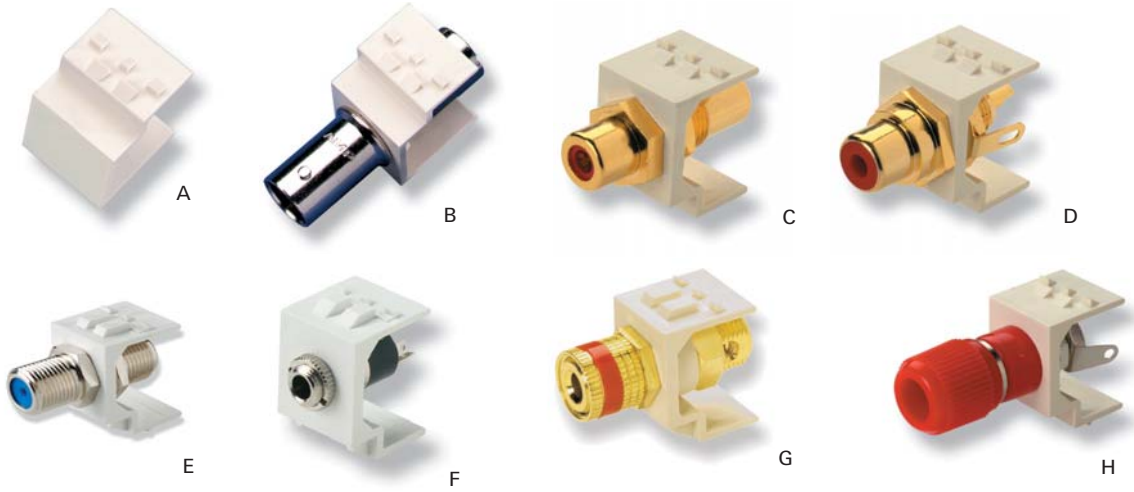

Description	Figure	Part Number
Blank	A	1116412-X
BNC Coupler	B	1339124-X
RCA Coupler	Red Dielectric	C 1375361-X
	White Dielectric	- 1375362-X
	Yellow Dielectric	- 1375363-X
	Green Dielectric	- 1933192-X
	Blue Dielectric	- 1933193-X
	Orange Dielectric	- 1933194-X
RCA, Solder Termination	Red Dielectric	D 1375364-X
	White Dielectric	- 1375365-X
	Yellow Dielectric	- 1375366-X
F-Connector Coupler, 2 GHz	E	1499855-X
3.5 mm Stereo, Mini-Headphone, Solder Termination	F	1479086-X
3.5 mm Stereo, Mini-Headphone, Screw Terminal	-	1933582-X
Speaker Post	Black Stripe	- 1479190-X
	Red Stripe	G 1479191-X
Binding Post	Black	- 1375359-X
	Red	H 1375360-X
RCA to F-Connector	I	1933096-X

X denotes insert color: -1 = Almond, -2 = Black, -3 = White, -4 = Gray, 1--1 = Electrical Ivory



Product Facts

- Provide connections for different media types
- Configure faceplates to handle various services
- May be used in straight or angled faceplates, SL Series Faceplate Module, and Mounting Straps
- Inserts easily snap into SL Series Modules, Mounting Straps, and Standard Faceplates

3

161

SL Series Inserts

SL Series Multimedia Jacks

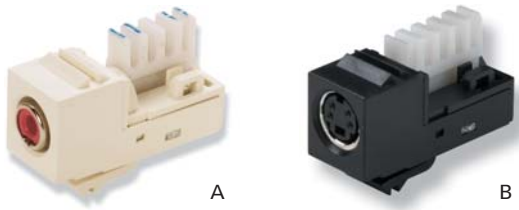

Description	Figure		Part Number
RCA	A	Red Dielectric	1479230-X
		White Dielectric	1479231-X
		Yellow Dielectric	1479232-X
S-Video	B		1375149-X

X denotes color: -1 = Almond, -2 = Black, -3 = White, -4 = Gray, 1--1 = Electrical Ivory

Product Facts

- For use where distances are less than 130 ft.
- Uses Standard 110 Termination and will accept 26-22 AWG conductors
- RCA Multimedia Jack
 - For audio and video signals
 - Uses one pair of twisted-pair cable white, red or yellow dielectrics to match home theater equipment
- S-Video Multimedia Jack
 - For S-Video Y/C (Luminance/Chrominance Black and White/Color) signals
 - Uses two pairs of a standard twisted-pair cable

Optical Fiber SL Series Multimedia Inserts

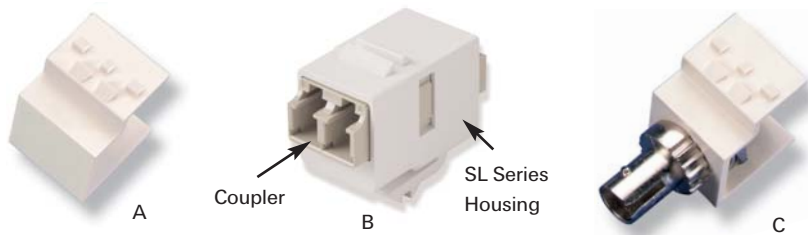

Description	Fiber Type	Figure	LC Coupler and Housing Color	Part Number
Blank		A	—	1116412-X
LC Coupler	62.5/125um	B	Beige	1-1933284-2
	50/125um		Black	1-1933284-1
	XG		Aqua	1933284-6
	(LO 850nm 50/125um)			
SC Simplex Coupler	Single-mode		Blue	1933286-4
	Single-mode APC		Green	1933286-3
ST Coupler	Multimode or Single-mode	—	—	1499836-X
ST Coupler	Multimode	C	—	1339123-X
	Single-mode	C	—	1479181-X
MT-RJ SL Series Housing		D	—	1374416-Y

X denotes insert color: -1 = Almond, -2 = Black, -3 = White, -4 = Gray, 1--1 = Electrical Ivory

Y denotes color: -1 = Almond, -2 = Black, -3 = White, -4 = Gray, -5 = Orange, -6 = Blue, -7 = Red, -8 = Yellow, -9 = Green, 1--0 = Violet, 1--1 = Electrical Ivory, 2--3 = Rose, 2--4 = Aqua, 2--5 = Brown, 2--6 = Slate

Product Facts

- Provide connections for different media types
- Configure faceplates to handle various services
- May be used in straight or angled faceplate modules
- Inserts easily snap into SL Series Modules, mounting straps, SL Series patch panels, and standard faceplates
- MT-RJ SL Series housing accepts one MT-RJ Jack sold separately (see Chapter 2.2)
- For LC SECURE Couplers, see Chapter 4

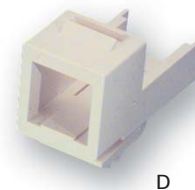

XG Category 6A AMP-TWIST Shielded Modular Jacks



Description	Wiring Pattern	Part Number
Cat 6A, Shielded	T568A/T568B	1711342-1
	with Dust Cover	1711160-1
Side Entry	T568A/T568B	1711343-1
Cat 6A, Shielded	with Dust Cover	1711295-1

Product Facts

- Meets or exceeds all TIA/EIA Category 6A performance standards
- Will allow 10GBASE-T (IEEE 802.3an) on 100 m channels
- Easy installation with only 2 parts
- Termination time: about 90 seconds (using AMP NETCONNECT SL Series Termination Tool, without Lacing Fixture-1725150-3 (see Chapter 1.7)
- Patented shield clamp
- Integrated strain relief
- Integrated dust cover option
- Re-usable
- Universal wiring label permits wiring to T568A or T568B
- 8-Position RJ45 Modular Jacks for 1-, 2-, 3-, and 4-Pair applications
- RoHS compliant

3

SL Series Category 6 Modular Jacks



Description	Wiring Pattern	Part Number	
Cat 6 Unshielded	T568A/T568B	1375055-X	
		Bulk Packaged - 25 Jacks	Y-1375055-Y
		With Dust Cover	1375187-X
Cat 6 Shielded	T568A/T568B	180° (Rear) Entry	1375188-1*
		90° (Side) Entry	1479552-1*

X denotes color: -1 = Almond, -2 = Black, -3 = White, -4 = Gray, -5 = Orange, -6 = Blue, -7 = Red, -8 = Yellow, -9 = Green, 1--0 = Violet, 1--1 = Electrical Ivory

Y denotes color and bulk package: 2- -1 = Almond, 2--2 = Black, 2--3 = White, 2--4 = Gray, 2--5 = Orange, 2--6 = Blue, 2--7 = Red, 2--8 = Yellow, 2--9 = Green, 3--0 = Violet, 3--1 = Electrical Ivory

*Note: Shielded jacks are not available in colors and do not accept strain reliefs.

Product Facts

- Thin profile improves outlet density
- Modular Jacks available with integral dust covers
- 180° or 90° cable dress for easy termination
- Universal wiring label permits wiring to T568A or T568B
- Meets or exceeds all TIA and ISO component performance requirements
- Bend-limiting strain relief included with unshielded jacks
- UL Listed: E8 1956
- 8-Position RJ45 Modular Jacks for 1-, 2-, 3- and 4-Pair applications
- Can be terminated with either SL Series Modular Jack Termination Tool or standard 110 punch-down tools (see Chapter 1.7)
- RoHS compliant
- For RJ45 SECURE jacks, see Chapter 4

163

SL Series Modular Jacks

SL Series Category 5e Modular Jacks



Description	Wiring Pattern	Part Number	
Cat 5e Unshielded	T568A/T568B	Bulk Packaged - 25 Jacks	1375191-X
		With Dust Cover	Y-1375191-Y
Cat 5e Shielded	T568A/T568B	180° (Rear) Entry	1375189-1*
		90° (Side) Entry	1479717-1*

X denotes color: -1 = Almond, -2 = Black, -3 = White, -4 = Gray, -5 = Orange, -6 = Blue, -7 = Red, -8 = Yellow, -9 = Green, 1--0 = Violet, 1--1 = Electrical Ivory

Y denotes color and bulk package: 2- -1 = Almond, 2- -2 = Black, 2- -3 = White, 2- -4 = Gray, 2- -5 = Orange, 2- -6 = Blue, 2- -7 = Red, 2- -8 = Yellow, 2- -9 = Green, 3--0 = Violet, 3--1 = Electrical Ivory

*Note: Shielded jacks are not available in colors and do not accept strain reliefs.

Product Facts

- Thin profile improves outlet density
- Modular Jacks available with integral dust covers
- 180° or 90° cable dress for easy termination
- Universal wiring label permits wiring to T568A or T568B
- Meets or exceeds all TIA and ISO component performance requirements
- Bend-limiting strain relief included with unshielded jacks
- UL Listed: E81956
- 8-Position RJ45 Modular Jacks for 1-, 2-, 3- and 4-Pair applications
- Can be terminated with either SL Series Modular Jack Termination Tool (1725150-1 in Chapter 1.7) or standard 110 punch-down tools (in Chapter 1.7)
- RoHS compliant

SL Series Category 3 Modular Jacks

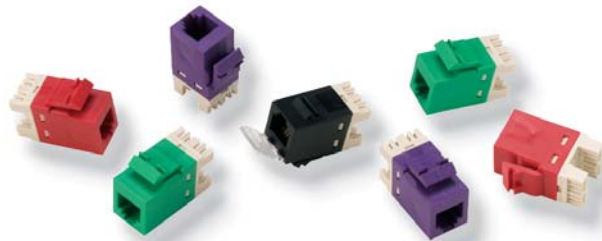

Description	Wiring Pattern	Part Number	
Cat 3 Unshielded	RJ11c/RJ14c/RJ25c	Bulk Packaged - 25 Jacks	1375192-X
		With Dust Cover	Y-1375192-Y

X denotes color: -1 = Almond, -2 = Black, -3 = White, -4 = Gray, -5 = Orange, -6 = Blue, -7 = Red, -8 = Yellow, -9 = Green, 1--0 = Violet, 1--1 = Electrical Ivory

Y denotes color and bulk package: 2- -1 = Almond, 2- -2 = Black, 2- -3 = White, 2- -4 = Gray, 2- -5 = Orange, 2- -6 = Blue, 2- -7 = Red, 2- -8 = Yellow, 2- -9 = Green, 3--0 = Violet, 3--1 = Electrical Ivory

Product Facts

- Thin profile improves outlet density
- Modular Jacks available with integral dust covers
- 180° or 90° cable dress for easy termination
- UL Listed: E81956
- 6-Position RJ11c/RJ14c/RJ25c Modular Jacks for 1-, 2- and 3-Pair applications
- Can be terminated with either SL Series Modular Jack Termination Tool (1725150-1 in Chapter 1.7) or standard 110 punch-down tools (in Chapter 1.7)
- RoHS compliant

SL Series Modular Jack Strain Reliefs

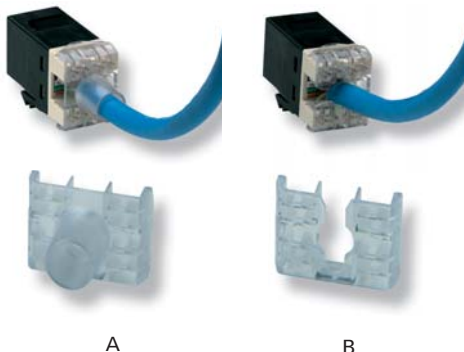

Product Facts

- Provide strain relief for terminated cables in the Work Area
- For use with unshielded SL Series Modular Jacks only

Description	Used with	Color	Figure	Part Number
Bend-Limiting Strain Relief	Category 6	Smoked Gray	A	1375200-1
	Category 5e	Blue	A	1375200-2
Strain Relief	Category 6, 5e, 3	Clear	B	1375157-1

SL Series Toolless Modular Jacks

SL Series Toolless Category 5e Modular Jacks



Description	Wiring Pattern	Part Number
Cat 5e Unshielded	T568A/T568B	1116604-X
	With Dust Cover	1339189-X
Cat 5e Shielded	T568A/T568B	1339015-1*

X denotes color: -1 = Almond, -2 = Black, -3 = White, -4 = Gray, -5 = Orange, -6 = Blue, -7 = Red, -8 = Yellow, -9 = Green, 1--0 = Violet, 1--1 = Electrical Ivory

*Note: Shielded jacks are not available in colors.

Product Facts

- Thin profile improves outlet density
- Terminate with common pliers
- Hinged stuffer cap simplifies assembly
- Jacks available with integral dust covers
- Universal wiring label permits wiring to T568A or T568B
- Meets or exceeds all TIA and ISO component performance requirements
- UL Listed: E81956
- 8-Position RJ45 Modular Jacks for 1-, 2-, 3- and 4-Pair applications
- RoHS compliant

3

SL Series Toolless Category 3 Modular Jacks



Description	Wiring Pattern	Part Number
Cat 3 Unshielded	RJ11c/RJ14c/RJ25c	1116603-X
	With Dust Cover	1339188-X

X denotes color: -1 = Almond, -2 = Black, -3 = White, -4 = Gray, -5 = Orange, -6 = Blue, -7 = Red, -8 = Yellow, -9 = Green, 1--0 = Violet, 1--1 = Electrical Ivory

Product Facts

- Thin profile improves outlet density
- Terminate with common pliers
- Jacks available with integral dust covers
- UL Listed: E81956
- 6-Position RJ11c/RJ14c/RJ25c Modular Jacks for 1-, 2- and 3-Pair applications
- RoHS compliant

165

110Connect Modular Jacks and Accessories

3

110Connect Category 5e Modular Jacks



Description	Wiring Pattern	Part Number
Category 5e, Unshielded	T568A/T568B	406372-X
	Bulk Packaged - 25 Jacks	Y-406372-Y
Category 5e, Shielded	T568A/T568B	1116515-1*

X denotes color: -1 = Almond, -2 = Black, -3 = White, -4 = Gray, -5 = Orange, -6 = Blue, -7 = Red, -8 = Yellow, -9 = Green, 1--0 = Violet, 1--1 = Electrical Ivory

Y denotes color and bulk package: 2--1 = Almond, 2--2 = Black, 2--3 = White, 2--4 = Gray, 2--5 = Orange, 2--6 = Blue, 2--7 = Red, 2--8 = Yellow, 2--9 = Green, 3--0 = Violet, 3--1 = Electrical Ivory

*Note: Shielded jacks are not available in colors.

Product Facts

- Category 5e Modular Jacks meet or exceed TIA and ISO requirements
- Universal wiring label permits termination to either T568A or T568B
- UL Listed: E81956
- Can be terminated with standard 110 punch-down tools (see Chapter 1.7)
- RoHS compliant

110Connect Category 3 Modular Jacks

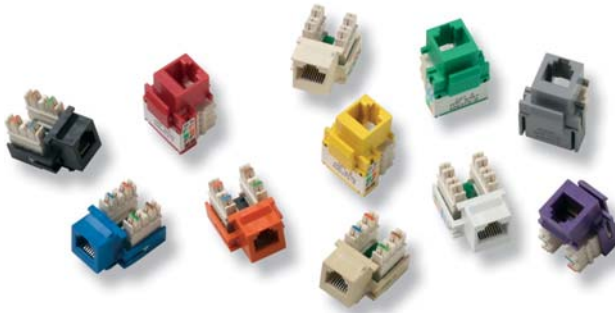

Description	Wiring Pattern	Part Number
Category 3, 8-Position	T568A/T568B	406373-X
Category 3, 6-Position	RJ11C/RJ14C/RJ25C	406375-X

X denotes color: -1 = Almond, -2 = Black, -3 = White, -4 = Gray, -5 = Orange, -6 = Blue, -7 = Red, -8 = Yellow, -9 = Green, 1--0 = Violet, 1--1 = Electrical Ivory

Product Facts

- Category 3 Jacks meet or exceed TIA and ISO requirements
- Universal wiring label for 8-position jacks permits termination to either T568A or T568B
- UL Listed: E81956
- Can be terminated with standard 110 punch-down tools (see Chapter 1.7)
- RoHS compliant

110Connect Stuffer Caps

PART NUMBER 569332-1

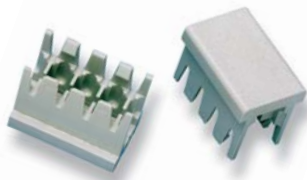

Note: 50 per bag.

Product Facts

- Available as an alternative termination method
- Provide additional strain relief
- Each stuffer cap accommodates 2 pairs
- For 110Connect Modular Jacks only

166

Multimedia Security Outlet

PART NUMBER 1116535-1



Product Facts

- Designed to provide a high-capacity outlet with the flexibility to accommodate a wide assortment of multimedia inserts
- Ideally suited for “high-low” (remote monitor) outlet applications in classrooms and training facilities
- Capable of supporting up to nine ports of copper, coax and/or optical fiber connectivity as well as an SVGA and a duplex optical fiber adapter
- Accepts all 110Connect Modular Jacks and all SL Series Jacks (see Chapter 1.2), duplex optical fiber adapters (see Chapter 2.2), all MT RJ Outlet Jacks (see Chapter 2.2) and Inserts (see Chapter 1.4)
- Accepts RJ45 SECURE jacks (see Chapter 4)

3

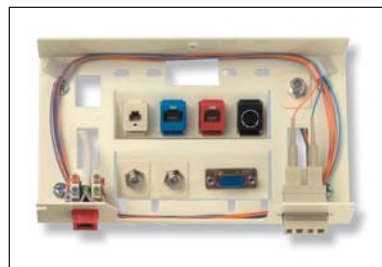

167

Surface Mount Outlet

Surface Mount Outlet
PART NUMBER 557366-1



Product Facts

- Provides a convenient and aesthetically pleasing workstation outlet for virtually all network needs
- Capability to install mixed media: coax, fiber and twisted pair
- Simply select the adapter kits for the media being used and install them in the Surface Mount Outlet
- The kit is shipped with matching icons. Additional icons in Chapter 8

3

Description	Part Number
Assembly - Top, bottom, label, cover, hardware, 8 blank inserts	557366-1
Blank Insert	557361-1
Surface Raceway Adapter	557685-1
Inserts	
Duplex ST or Duplex SC (Fiber receptacles not included, see Chapter 2.2)	1116111-1
Dual ST Bulkhead Adapter (Receptacle included)	557350-1
AMP Communications Outlet Adapter (Requires single-port installation kit and connector insert)	557364-1
Single 110Connect Jack, SL Series or MT-RJ (Jack not included)	1116098-1
Dual 110Connect Jack, SL Series or MT-RJ (Jacks not included)	557775-1
Dual BNC Jack-to-Jack Adapter	557776-1
F Series Jack-to-Jack Adapter	557772-1
Accessories	
Underfloor Duct Adapter Kit	557913-1

Surface Mount Outlet is available in Almond only.

Suggested Loading Pattern for the Surface Mount Outlet

	Dual ST or SC	BNC Feed Through	110Connect, SL Series, MT-RJ Jacks	Dual 110Connect, SL Series, MT-RJ Jacks
Dual ST or SC			X	
BNC Feed Through			X	X
110Connect, SL Series, MT-RJ Jacks	X	X	X	X
Dual 110Connect, SL Series, MT-RJ Jacks		X	X	

Application Chart

The application chart is a suggested loading pattern for the Surface Mount Outlet. The Surface Mount Outlet inserts can be configured according to network requirements. The size of the connectors, however, limits some applications. In particular, the corner slots present some loading problems when using larger connectors. Therefore, this application chart was developed to assist in adjacent corner connector configuration. The "X" denotes the suggested loading patterns for the corner slots of the Surface Mount Outlet.

Universal Office Boxes and Accessories

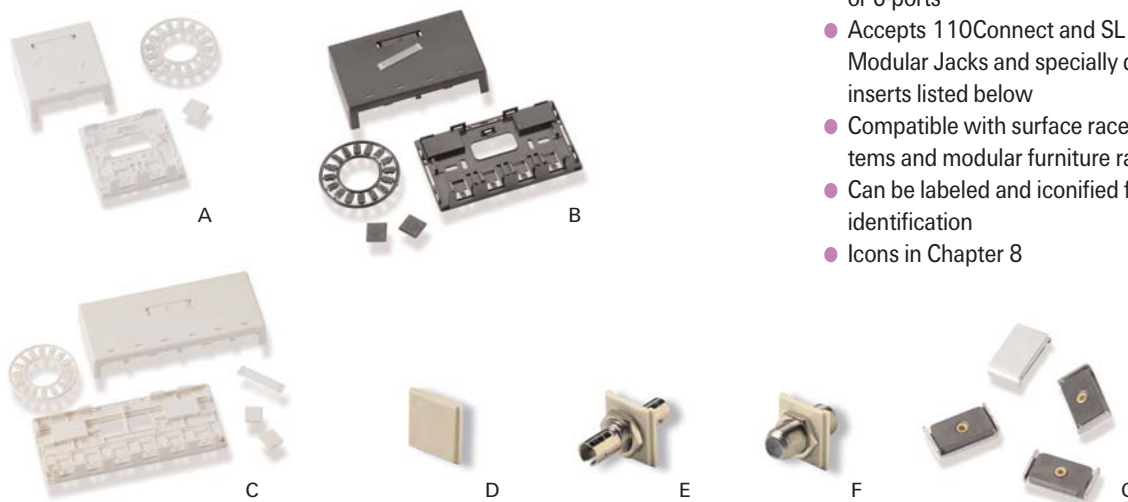

Product Facts

- Provide flexible surface mounting of 2-, 4- or 6-ports
- Accepts 110Connect and SL Series Modular Jacks and specially designed inserts listed below
- Compatible with surface raceway systems and modular furniture raceways
- Can be labeled and iconified for easy port identification
- Icons in Chapter 8

3

Description		Figure	Dimensions	Part Numbers
Universal Office Box	2-Port	A	1.1" H x 3.0" W x 3.0" D	1479488-X
	4-Port	B	1.1" H x 5.0" W x 3.0" D	1479489-X
	6-Port	C	1.1" H x 7.0" W x 3.0" D	1479490-X
Universal Office Box Inserts	Blank	D	-	1479494-X
	ST, Multimode	E	-	1479495-X
	F-Connector	F	-	1479496-X
Surface Mount Magnets for Universal Office Boxes*	Pack of 4	G	0.2" H x 1.1" W x 0.6" D	1479398-1*

X denotes color: -1 = Almond, -2 = Black, -3 = White, -4 = Gray, 1--1 = Electrical Ivory
 *Note: Surface Mount Magnets are for use with 4- and 6-Port Universal Office Boxes Only.

Office Boxes

12-Port Universal Office Box

PART NUMBER 1479358-X



X denotes color: -1 = Almond, -2 = Black, -3 = White, -4 = Gray, 1--1 = Electrical Ivory

Product Facts

- Accepts all 110Connect and SL Series Jacks, MT-RJ Outlet Jacks, and SL Series Multimedia Inserts
- Molded numbering for each port
- Uses same labeling and label covers as standard faceplates
- Low profile design
- Features fiber loop storage
- Compatible with most surface raceways
- Mounts to standard NEMA single and double gang surface boxes
- Integrated modular jack holder for terminations
- "Invisible" Icon holes stay hidden until used
- Accommodates up to twelve 4-pair cables

3

Modular Jack Boxes

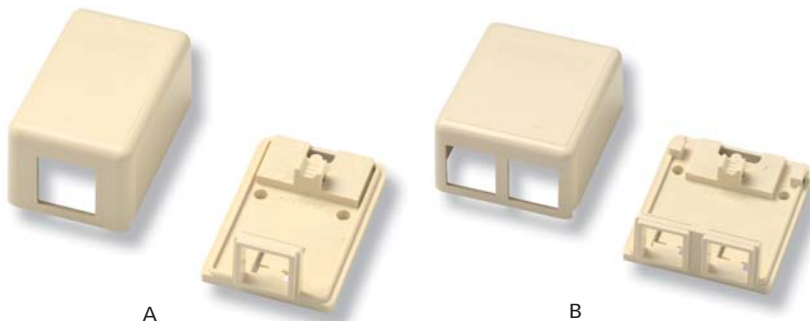

Product Facts

- Accepts unshielded 110Connect and all SL Series Jacks and MT-RJ Outlet Jacks
- "Invisible" icon holes remain hidden when not used

Description	Figure	Part Number
1-Port	A	1116697-X
2-Port	B	1116698-X
Blank Insert, Almond only		1933172-1

X denotes color: -1 = Almond, -2 = Black, -3 = White, -4 = Gray, 1--1 = Electrical Ivory

NOTE: Modular jack boxes do not accept Multimedia inserts.

Blank Insert only works with these boxes.

Surface Boxes

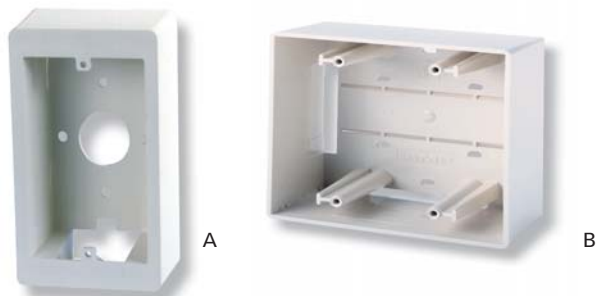

Product Facts

- One-piece construction simplifies installation
- Single gang surface box is 1 3/4" deep
- Double gang surface box is 2" deep

Description	Figure	Part Number
Single Gang	A	558251-X
Double Gang	B	569499-X

X denotes color: -1 = Almond, -2 = Black, -3 = White, -4 = Gray, 1--1 = Electrical Ivory

AMP Communications Outlet (ACO)

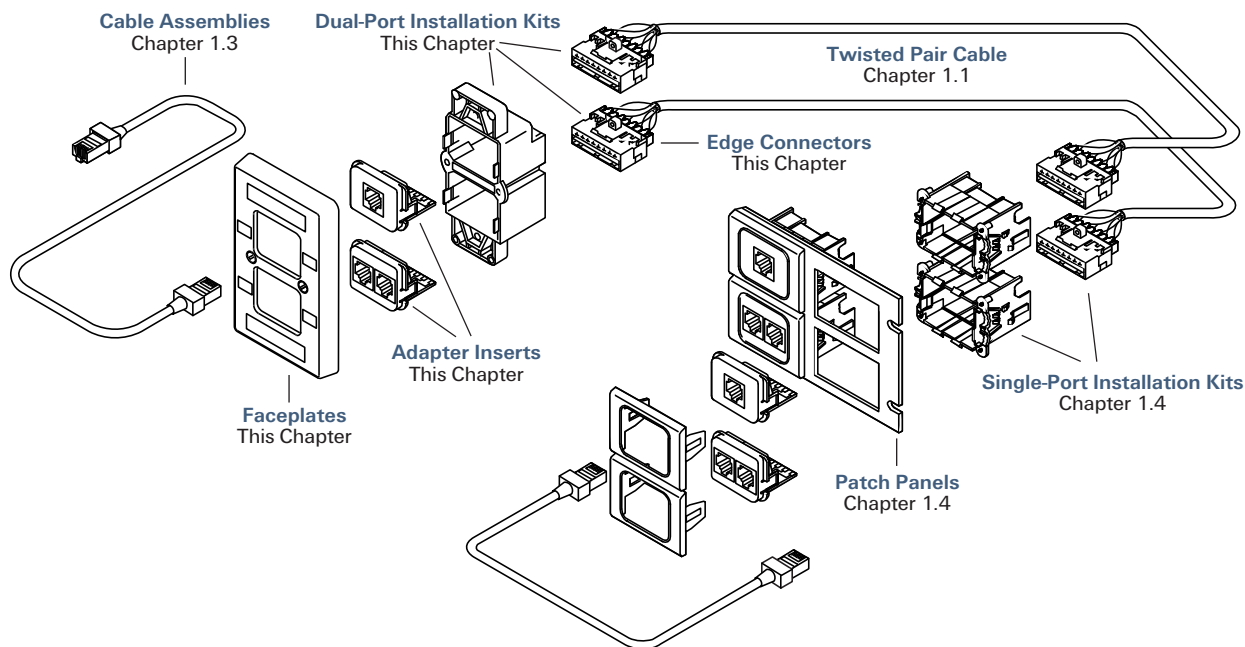

3

The core of the ACO system is the installation kit which mounts into standard electrical boxes. Edge connectors in the rear of the installation kit are terminated to horizontal cabling. The edge connectors, in turn, accept pluggable inserts which snap into the edge connectors to provide the interface for equipment (phone, computer, printer, etc.).

This combination of card edge connectors and pluggable inserts provides a reconfigurable connector interface which doesn't require re-termination of the cable.

The inserts take care of providing the appropriate connector interface and pinout to match the equipment in use. When that equipment changes, the adapter insert can be replaced by simply removing the faceplate, snapping out the old insert and snapping in a new one, a process which takes about a minute.

Dual connector inserts also help to maximize cable usage through sheath-sharing, combining two applications, such as 100BASE-T, on one 4-pair cable.

How to Order an AMP Communications Outlet System

- Choose the appropriate installation kit to meet your cable (shielded or unshielded, Category 5e or Category 6) and mounting requirements:
 - Dual-port kits for fixed wall, Access
 - Floor Workstation Module and surface mounted applications
 - Single-port kits for modular furniture, AMP Furniture Outlet, AMP Surface Mount Outlet and undercarpet applications
- Choose the appropriate inserts to match your applications:
 - Category 6 inserts
 - Category 5e inserts
 - Category 3 inserts
 - 150 Ohm STP inserts

Make sure to order inserts for patch panels as well as workstation outlets.

- Choose the appropriate faceplate
- Choose the appropriate shielded or unshielded patch panel kit

171

AMP Communications Outlet (ACO)

ACO Dual-Port Installation Kits

3



Product Facts

- Used to mount ACO Inserts
- Category 6 Dual-Port Installation Kits -
 - Combines the flexibility and adaptability of the ACO System with the performance and headroom of Category 6
 - Meets or exceeds TIA and ISO requirements for Category 6 component performance requirements when combined with Category 6 Inserts
 - Category 6 ACO Installation Kits are backwardly compatible with standard ACO Inserts
 - Unshielded kits include unshielded insert housing, and two edge connectors
 - Unshielded kits are recommended for installation in 4" square x 2 1/2" deep electrical boxes with standard 100 Ohm UTP cable
- Standard Dual-Port Installation Kits
 - Both 110-Style and AMP-BARREL connectors provide Category 5e performance when combined with Category 5e inserts
 - Available in both shielded and unshielded kits
 - Unshielded kits include unshielded insert housing, and two edge connectors
 - Unshielded kits are recommended for installation in 4" square x 2 1/2" deep electrical boxes with standard 100 Ohm UTP cable
 - Shielded kits include shielded insert housing, two edge connectors, ground shield, and shield clip/strain-relief
 - Shielded kits are recommended for installation in 4" square x 2 1/2" deep electrical boxes with standard 100 Ohm shielded cable (110-Style Edge Connectors) or 150 Ohm Type 1 cable (AMP-BARREL Edge Connectors)

Description	Edge Connector	Figure	Part Number	
Category 6 Dual-Port Installation Kit	Unshielded	110-Style	A	1479306-1
		AMP BARREL	C	406352-1
Standard Dual-Port Installation Kit	Unshielded	110-Style	B	406091-1
	Shielded	AMP BARREL	-	555601-1

AMP Communications Outlet (ACO)

ACO Low Profile Dual-Port Installation Kits



Product Facts

- Used to mount ACO Inserts in flush mount configurations
- Offered in four colors
- Accepts icons and labels for easy identification
- Kits include unshielded insert housing and two edge connectors
- Recommended for installation in 4" square x 2 1/2" deep electrical boxes with standard 100 Ohm UTP cable
- Category 6 Dual-Port Installation Kits - Meets or exceeds TIA and ISO requirements for Category 6 component performance requirements when combined with Category 6 Inserts
- Category 6 ACO Installation Kits are backwardly compatible with standard ACO Inserts
- Standard Dual-Port Installation Kits Provide Category 5e performance when combined with Category 5e inserts

3

Description	Edge Connector		Figure	Part Number
Category 6, Dual-Port, Low Profile Installation Kit	110-Style	Unshielded	A	1479307-1
Standard, Dual-Port, Low Profile Installation Kit	110-Style	Unshielded	B	406090-1
Low Profile Faceplate			C	406089-X

X denotes faceplate color: -1 = Almond, -3 = Black, -4 = Gray, -5 = White, -6 = Electrical Ivory

173

AMP Communications Outlet (ACO)

3

ACO Single Gang Dual-Port Faceplate Kits

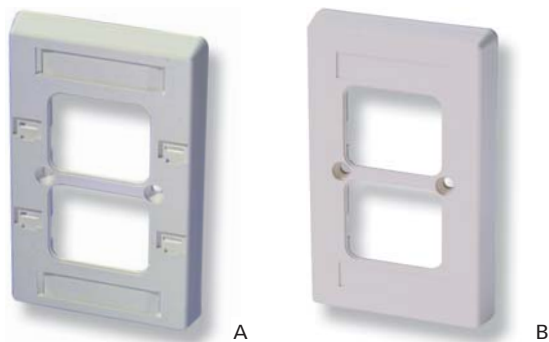

Product Facts

- Tyco Electronics recommends that a double gang box be used in all initial installations to allow for future expansion – a double gang faceplate with one side blank is initially installed and is replaced with a double gang faceplate as additional outlets are needed
- Icons in Chapter 8

Description			Figure	Part Number
ACO Dual-Port Faceplate Kit	Single Gang	Iconable	A	558510-X
		Non-Iconable	B	555650-X

X denotes faceplate color: -1 = Almond, -3 = Black, -4 = Gray, -5 = White, -6 = Electrical Ivory

ACO Double Gang Dual-Port Faceplate Kits

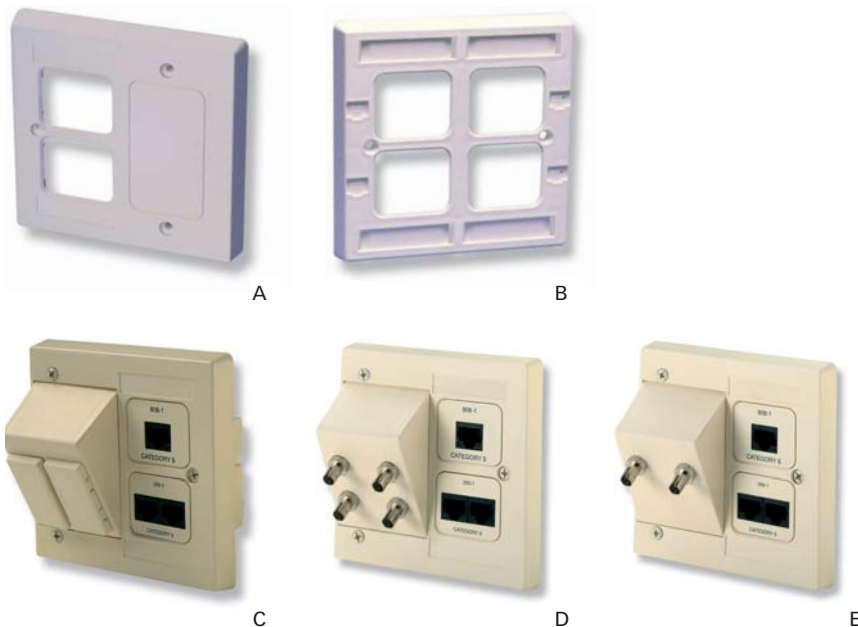

Product Facts

- Tyco Electronics recommends that a double gang box be used in all initial installations to allow for future expansion – a double gang faceplate with one side blank is initially installed and is replaced with a double gang faceplate as additional outlets are needed
- Icons in Chapter 8
- ACO Inserts and Installation Kits sold separately (this Chapter)
- Optical Fiber adapters suitable for multimode connectors
- 503662 features integral dust cover doors for optical fiber adapters

Description			Figure	Part Number	
ACO Dual-Port Faceplate Kit	Double Gang	One Side Blank	Non-Iconable	A	556340-X*
		Two Dual-Port Installation Kits	Non-Iconable	–	555670-X**
			Iconable	B	558512-X**
		Optical Fiber One Dual-Port ACO	Two Duplex Multimode SC Adapters	C	503662-2
			Four Multimode ST Adapters	D	502604-1
Two Multimode ST Adapters	E		502604-2		

X denotes faceplate color: -1 = Almond, -3 = Black, -4 = Gray, -5 = White, -6 = Electrical Ivory

*Note: Not available in Black or Gray

**Note: Requires removal of inside mounting ears from Installation kits (shielded kits only)

ACO Stainless Steel Faceplates

SEMTRON Faceplates for ACO

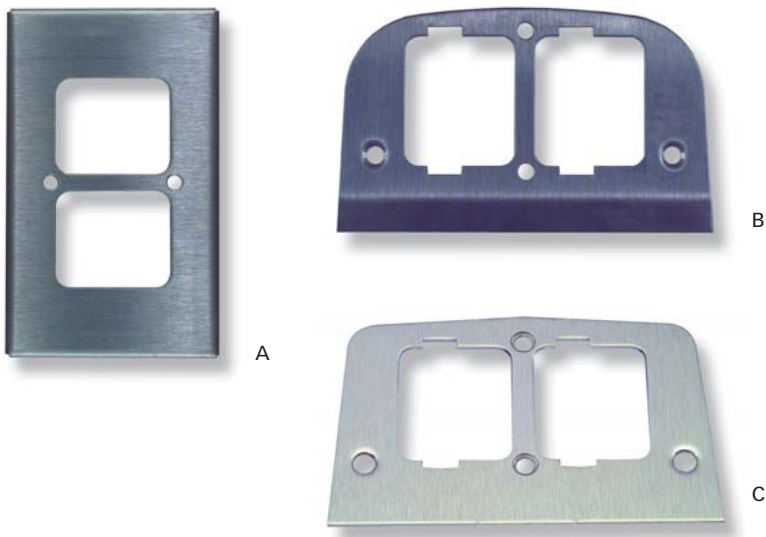

Product Facts

- Semtron, Inc., manufactures single gang faceplates for the AMP Communications Outlet in stainless steel and brass
- Special plates that allow the standard installation kits (555601) to be mounted in WALKERDUCT 500/501 pedestal series and HUBBELL LO-CON above-floor models FR-15/35/355/55 are available
- These and other custom faceplates are available directly from:
Semtron, Inc.
G-6465 Corunna Rd.
Flint, MI 48504
Phone: 1-800-732-9080
Fax: 810-732-9665
Email: semtron@semtron.com
www.semtron.com

3

Description		Figure	Part Number	
SEMTRON Stainless Steel Faceplates	Single Gang	A	555650-2	
	Single Gang Mounting Plate	HUBBELL "LO-CON" Service Fitting	B	HUBACO
		WALKER 500/501 Floor Fittings	C	B500ACO

ACO Double Gang Recessed Box & Accessories

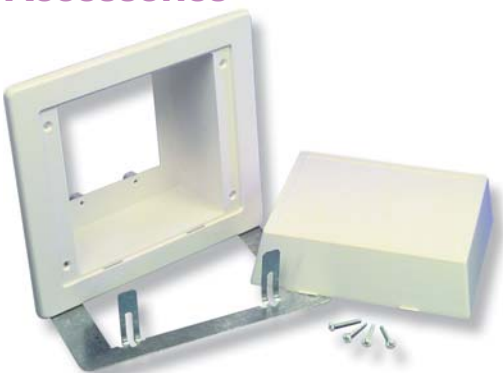

Product Facts

- Recessed box with mounting bracket and four screws
- Mounts directly to drywall or paneling (1/4" to 5/8" thick)
- Accepts two dual-port installation kits in this chapter
- Optional snap-on cover
- Faceplates are ordered separately

Description	Part Number
Double Gang Recessed Box with mounting bracket	556598-1
Snap-on cover	556599-1

175

ACO Single-Port Installation Kits

Category 6 ACO Single-Port Installation Kits

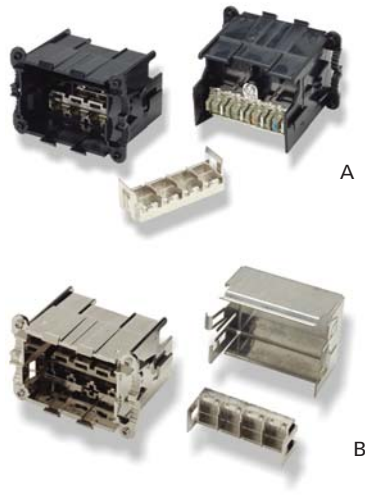

Product Facts

- Available in both shielded and unshielded kits
- Combines the flexibility and adaptability of the ACO System with the performance and headroom of Category 6
- Meets or exceeds TIA and ISO requirements for Category 6 component performance requirements
- Category 6 ACO Installation Kits are backwardly compatible with standard ACO Inserts
- Used to mount ACO Inserts
- Single-port module may be snapped into .040" - .090" thick panel with a minimum of 1 5/8" clearance behind the panel
- Optional screw mounting capability is provided for thicker panels
- Modular furniture faceplate kit adapts the single-port module for installation in standard modular furniture raceway knockouts
- Panel mount faceplates are available for custom applications
- Unshielded kit includes unshielded insert housing, edge connector, and shield clip/strain-relief
- Shielded kit includes shielded insert housing, edge connector, rear shield and shield clip/strain-relief

Description	Edge Connector		Figure	Part Number
Single Port Installation Kit	110-Style	Unshielded	A	1479317-1
		Shielded	B	1479318-1

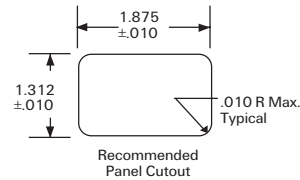

Standard ACO Single-Port Installation Kits

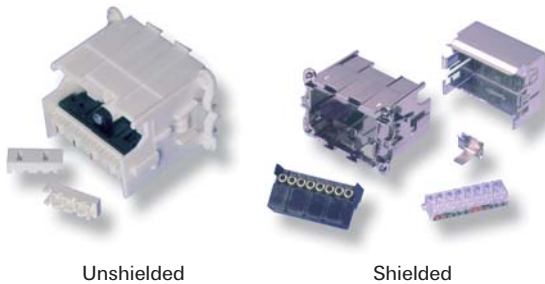

Product Facts

- Available in both shielded and unshielded kits
- Both 110-Style and AMP-BARREL connectors provide Category 5e performance when combined with Category 5e inserts
- Single-port module may be snapped into .040" - .090" thick panel with a minimum of 1 5/8" clearance behind the panel
- Optional screw mounting capability is provided for thicker panels
- Modular furniture faceplate kit adapts the single-port module for installation in standard modular furniture raceway knockouts
- Panel mount faceplates are available for custom applications
- Unshielded kit includes unshielded insert housing, edge connector, and shield clip/strain-relief
- Shielded kit includes shielded insert housing, edge connector, rear shield and shield clip/strain-relief

Description	Edge Connector	Part Number
Unshielded Single-Port Installation Kit	110-Style	406360-1
	AMP-BARREL	406389-1
Shielded Single-Port Installation Kit	110-Style	406361-1
	AMP-BARREL	406388-1

NOTE: 110-Style Edge Connectors are not for use with Type 1 Cable.

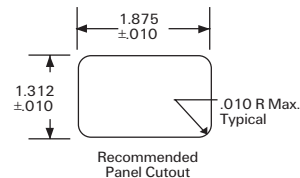

ACO Single-Port Faceplates

ACO Single-Port Faceplates For Modular Furniture

PART NUMBER 556679-X

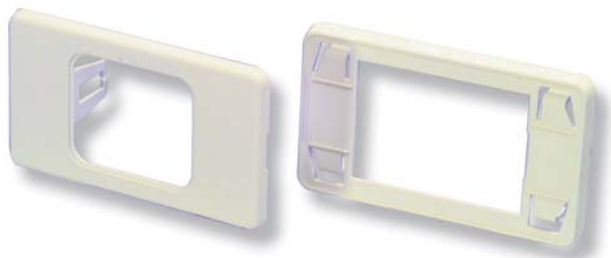

X denotes color: -1 = Almond, -3 = Black

NOTE: Many furniture panels may not provide the required depth when optional power systems are installed. If this is a factor, see AMP Furniture Outlet.

Product Facts

- Used to mount single-port module in a standard modular furniture raceway knockout
- Kit includes bezel and faceplate
- Requires 1 7/16" clearance behind the raceway

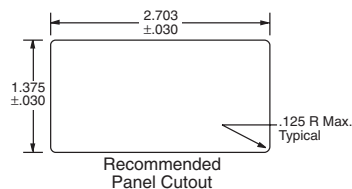

3

ACO Single-Port Faceplates For Panel Mount

PART NUMBER 556680-X



X denotes color: -1 = Almond, -3 = Black, -4 = Gray, -5 = White

NOTE: Many furniture panels may not provide the required depth when optional power systems are installed. If this is a factor, see AMP Furniture Outlet below.

Product Facts

- This outlet may be used with undercarpet fitting 555535 and for custom mount applications

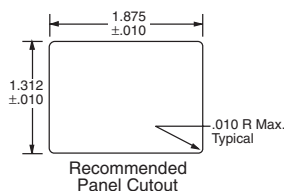

AMP Furniture Outlet

COVER KIT AND FRAME, PART NUMBER 557558-X
OPTIONAL BASE, PART NUMBER 557557-X



X denotes color: -1 = Almond, -2 = Black, -3 = Gray

Product Facts

- Provides a means of mounting a single-port AMP Communications Outlet plus an optional Keystone Jack in most modular furniture raceways
- Designed to fit the openings of most furniture raceway systems
- Assembled single-port installation kit extends approximately 3/4" beyond bottom of the frame into the furniture raceway
- Optional base available for surface mounting
- ACO Inserts in this Chapter

177

ACO Inserts

AMP Communications Outlet Inserts for 100 Ohm cable

AMP NETCONNECT ACO inserts comply with requirements of TIA/EIA-568-B and ISO 11801: 2002. Dual Category 5e inserts allow the combination of two applications on one 4-pair cable. Two 10BASE-T or two 16 Mbps token ring links may safely be combined on a single 4-pair Category 5e cable within certain design parameters. When combined with AMP NETCONNECT Category 5e cable, dual Category 5e inserts have been verified to support dual transmissions up to 100BASE-T and/or 155 Mbps ATM.

3

Note: The simplest way to test and certify an ACO installation that will use dual inserts is to use single 4-pair inserts for testing prior to installing the dual inserts.

Category 6 & 5e Single ACO Inserts

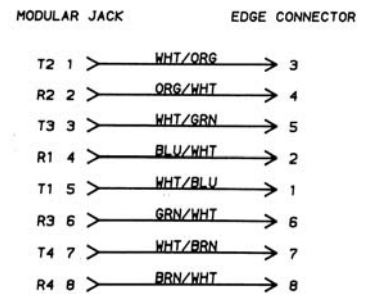
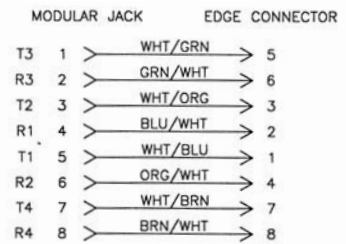
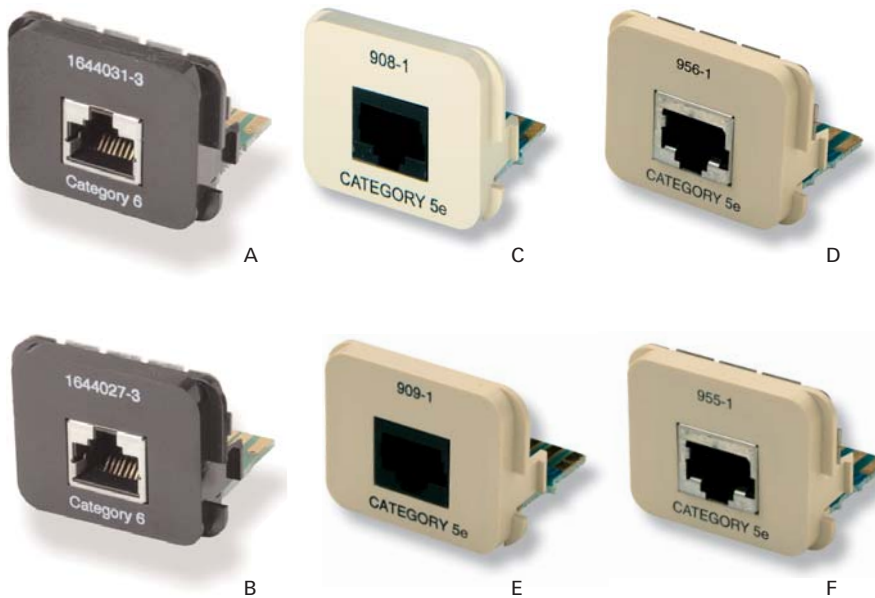

Description	Wiring		Figure	Part Number
Category 6 Inserts for 100 Ohm cable	Category 6, T568A	Unshielded/Shielded	A	1644031-X*
	Category 6, T568B	Unshielded/Shielded	B	1644027-X*
Enhanced Category 5 Inserts for 100 Ohm cable	Category 5e, T568A	Unshielded	C	558908-Y
		Shielded	D	406956-Y
	Category 5e, T568B	Unshielded	E	558909-Y
		Shielded	F	406955-Y

X denotes faceplate color: -1 = Almond, -3 = Black, -5 = White.
 Y denotes faceplate color: -1 = Almond, -3 = Black, -4 = Gray, -5 = White, -6 = Electrical Ivory
 *Note: For use with Category 6 ACO Installation Kits only.

Category 5e Dual ACO Inserts

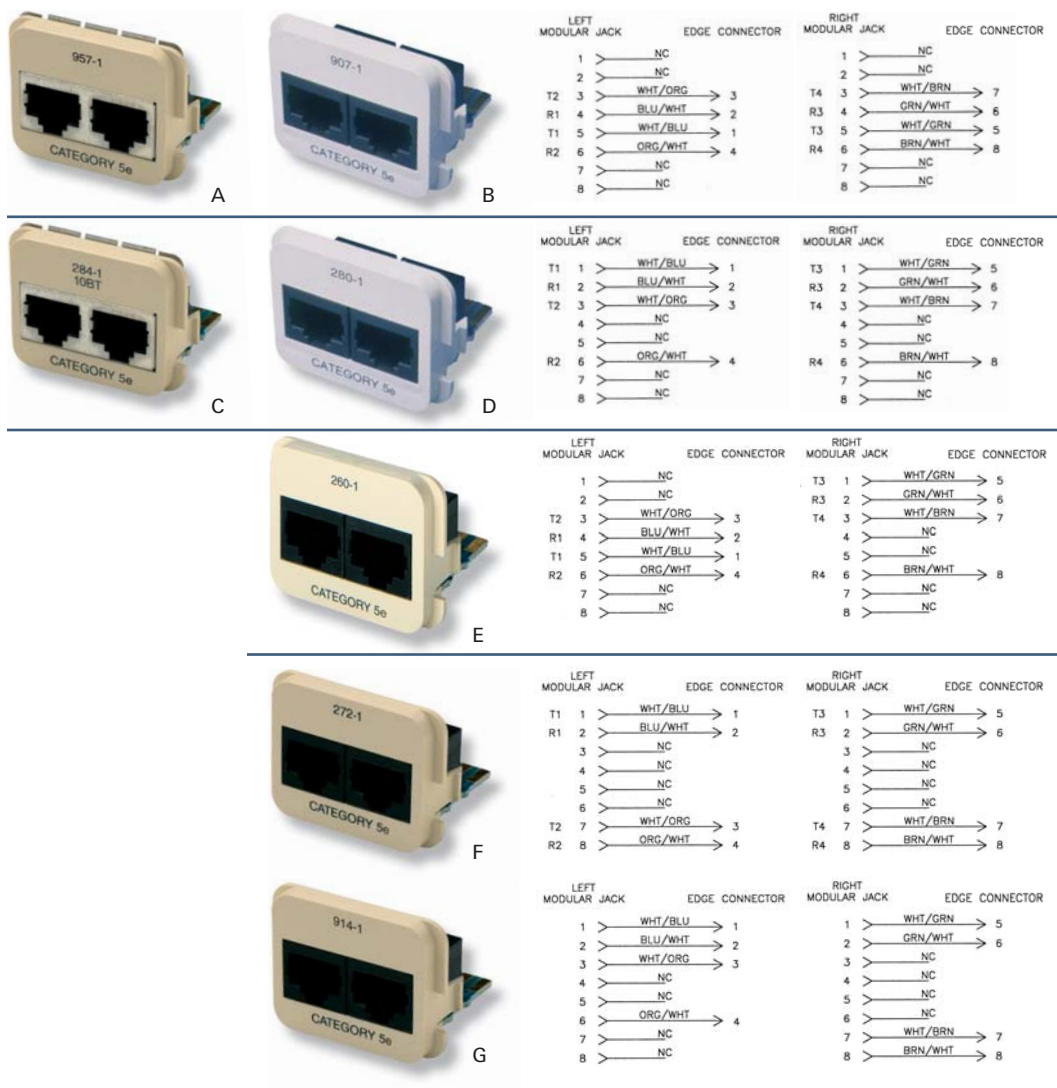

3

Wiring		Figure	Part Number
Dual Token Ring	Shielded	A	406957-X
	Unshielded	B	558907-X
Dual 10/100BASE-T	Shielded	C	557284-X
	Unshielded	D	557280-X
Token Ring & 10/100BASE-T	Unshielded	E	557260-X
Dual ATM/TP-PMD	Unshielded	F	557272-X
10/100BASE-T & ATM	Unshielded	G	558914-X

X denotes faceplate color: -1 = Almond, -3 = Black, -4 = Gray, -5 = White, -6 = Electrical Ivory

179

ACO Inserts

ACO Modular Jacks

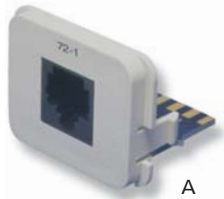

A

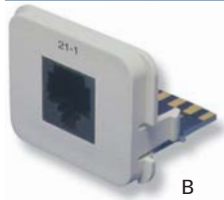
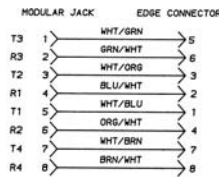

B



C

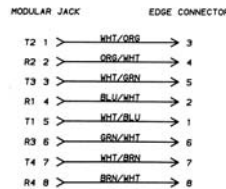

D

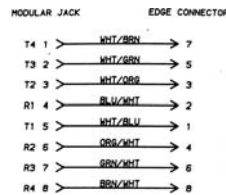

E

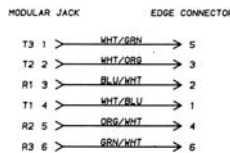

F

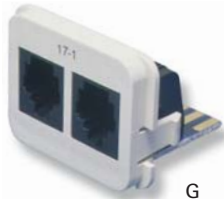
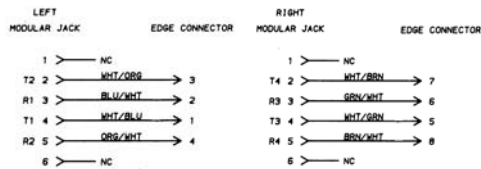

G

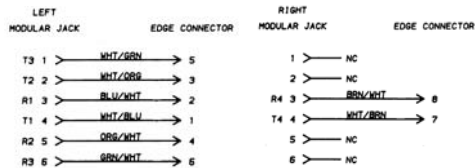

Description	Wiring		Figure	Part Number
Single 8-Position Modular Jack	T568A (10BASE-T & Token Ring Compatible)	Unshielded	A	555672-X
	T568B (10BASE-T & Token Ring Compatible)	Unshielded	B	555621-X
		Shielded	C	555669-X
Single 6-Position Modular Jack	USOC RJ61X	Unshielded	D	555625-X
	RJ11/RJ14/RJ25 Compatible	Unshielded	E	555611-X
		2-Pair/2-Pair	Unshielded	F
Dual 6-Position Modular Jack	3-Pair/1-Pair	Unshielded	G	555617-X

X denotes faceplate color: -1 = Almond, -3 = Black, -4 = Gray, -5 = White, -6 = Electrical Ivory

Miscellaneous ACO Inserts



Description	Figure	Part Number
Blank Insert Cover	A	555644-X
BNC Coupler	B	555642-Y*
F-Connector Coupler	C	555645-Z*

X denotes colors: -1 = Almond, -3 = Black, -5 = Gray, -9 = White, 1--1 = Electrical Ivory

Y denotes colors: -1 = Almond, -3 = Black, -4 = Gray, -5 = White

Z denotes colors: -1 = Almond, -3 = Black, -4 = Gray, -5 = White, -6 = Electrical Ivory

*Note: Card edge connector not used with this insert.

ACO Inserts for 150 Ohm 2-Pair Shielded Cable

Product Facts

- 4-Position Data Connector Insert is functionally equivalent to IBM #8310574 and is IEEE 802.5 compatible
- 100 to 150 Ohm impedance matching insert is used to allow 10/100BASE-T to operate on Type-1 cable

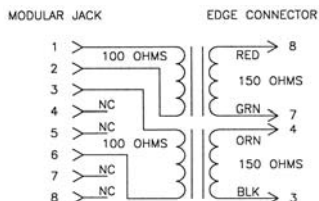
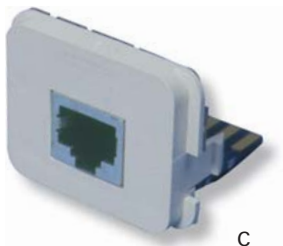
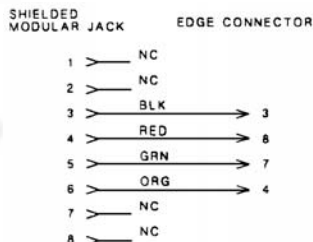
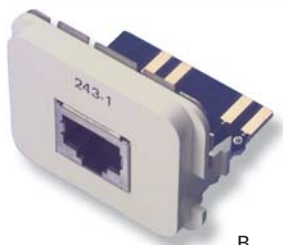
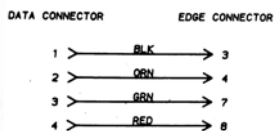
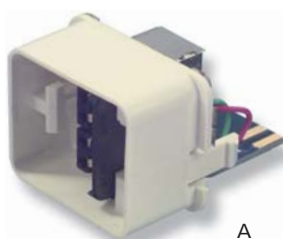

Description	Wiring	Figure	Part Number
Inserts for 150 Ohm 2-Pair cable	150 Ohm	4-Position Data Connector	Shielded A 555631-1
		8-Position Modular Jack	Token Ring Shielded B 557243-1
Almond color	100:150 Ohm Impedance Matching	8-Position Modular Jack	10/100BASE-T Shielded C 558912-1

ACO Accessories

ACO Edge Connector Assembly

Product Facts

- AMP-BARREL Pistol Grip edge connector is designed for use with the pistol grip tool and the punchdown tool (see Chapter 1.7)

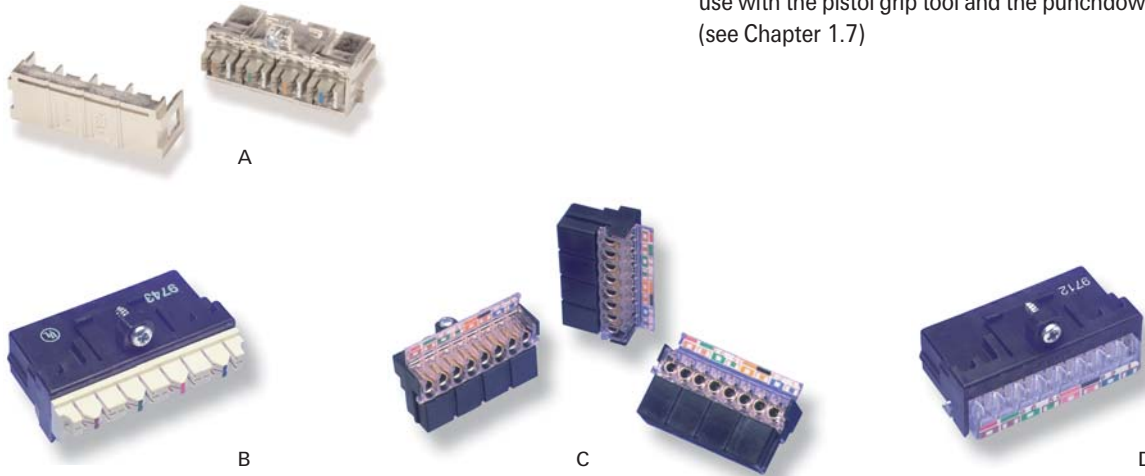

3

Description	Termination		Figure	Part Number
Edge Connector Kit	Category 6	110-Style	A	1479305-1
		110-Style	B	406350-1
	Category 5e	AMP-BARREL Pistol Grip Tool	C	406351-1
		AMP-BARREL	D	406397-1

ACO Ground Shield Kit

PART NUMBER 555725-1

Product Facts

- Used when two ports of connector housing are to be shielded



Products for WIREMOLD Raceways

Faceplates for WIREMOLD Raceways

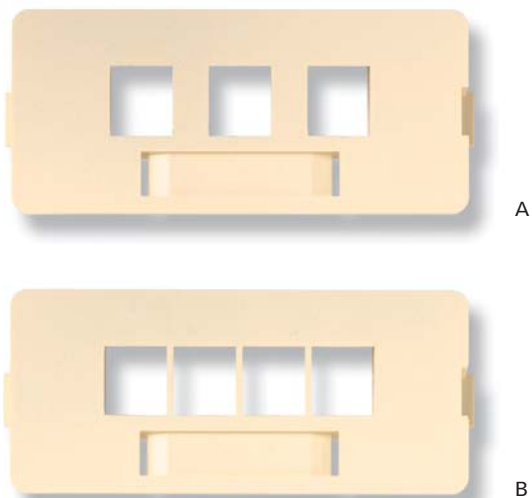

Product Facts

- Designed to be identical to WIREMOLD 5507 Series Faceplates and will mount in 4049, 5400, and 5500 series device plates and brackets
- 3-Port faceplate accepts all 110Connect and SL Series Jacks and Multimedia Inserts
- 4-Port faceplate accepts all SL Series Jacks and Multimedia Inserts
- "Invisible" icon holes remain hidden when not used

3

Description		Figure	Part Number
Faceplates for WIREMOLD Raceways	3-Port	A	1375050-X
	4-Port	B	1375049-X

X denotes color: -1 = Almond, -4 = Gray

WIREMOLD 2A Inserts

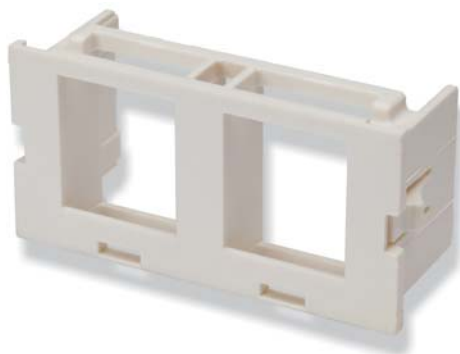

Product Facts

- Allows the use of SL Series Jacks in WIREMOLD raceways, poke-thru service fittings, and power poles
- Accepts up to two SL Series Jacks
- Does not accept SL Series Multimedia inserts
- Installation and configuration ease
- Modules feature a front load snap-in design for ease of installation and allowing outlet configuration changes to be made quickly
- Contact:

The Wiremold Company
 60 Woodlawn Street
 West Hartford, CT 06110
 1-800-621-0049
 FAX 860-232-2062
www.wiremold.com

Description	Color	Part Number
WIREMOLD 2A, 2-Port Inserts	Ivory	CM2-U2AMP
	White	CM2-U2AMP-WH
	Black	CM2-U2AMP-BK
	Gray - Steel Raceway	CM2-U2AMP-G
	Light Gray - Aluminum Raceway	CM2-U2AMP-GY

183

Access Floor Workstation Modules (AFWM)

Access Floor Workstation Modules



Product Facts

- Provide power and communications connectivity in raised flooring
- 2, 3, 4, and 5 gang sizes available
- For use with carpet squares
- Load bearing exceeds UL and agency requirements—
 - UL listed, CSA certified
 - UL 514A metallic outlet boxes
 - UL 514C non-metallic outlet boxes
 - UL 183 manufactured wiring system
 - CSA C22-2 No. 18-M1987 outlet boxes, conduit boxes and fittings
- Access Floor Workstation Modules shown loaded for reference only

3

5 Gang Access Floor Workstation Module
PART NUMBER 1116700-X



X denotes color: -1 = Almond, -2 = Storm Gray, -3 = Black, -4 = NEMA Gray

Product Facts

- Five Gang (two gang of power and three gang of communications)
- Accepts all standard AFWM Faceplates (see this Chapter)
- Large cable opening enables disassembly and relocation without re-termination of communications connectors
- Complies with NEC 300-22(c) requirements for use in environmental air spaces
- Dimensions: 8" x 12", 5.25" min. floor height (top of raised floor to top of main floor surface)

Access Floor Workstation Modules (AFWM)

5 Gang Access Floor Workstation Module

PART NUMBER 557601-X



X denotes color: -1 = Almond, -2 = Storm Gray, -3 = Black, -4 = NEMA Gray

Product Facts

- Five Gang – any combination of power and communications
- Accepts all standard AFWM Faceplates (see this Chapter)
- Outlets flip up above floor for easy access
- Large cable opening enables disassembly and relocation without re-termination of communications connectors
- Suitable for use in non-environmental air spaces
- Dimensions: 8" x 12", 5.5" min. floor height (top of raised floor to top of main floor surface)

3

4 Gang Access Floor Workstation Module

PART NUMBER 406376-X



X denotes color: -1 = Almond, -2 = Storm Gray, -3 = Black, -4 = NEMA Gray

Product Facts

- Four Gang – two accept duplex power receptacles, Two accept standard FLEX-MODE Faceplates
- Shallow profile provides easy access to connections
- Complies with NEC 300-22(c) requirements for use in environmental air spaces
- Dimensions: 8" x 12", 2.6" min. floor height (top of raised floor to top of main floor surface)

3 Gang Access Floor Workstation Module

PART NUMBER 558716-X



X denotes color: -1 = Almond, -2 = Storm Gray, -3 = Black, -4 = NEMA Gray

Product Facts

- Three Gang – any combination of power and communications
- Accepts all standard AFWM Faceplates (see this Chapter)
- Complies with NEC 300-22(c) requirements for use in environmental air spaces
- Dimensions: 7.375" x 7.375", 5.5" min. floor height (top of raised floor to top of main floor surface)

185

Access Floor Workstation Modules (AFWM)

2 Gang Access Floor Workstation Module

PART NUMBER 558718-X



X denotes color: -1 = Almond, -2 = Storm Gray, -3 = Black, -4 = NEMA Gray

Product Facts

- Two Gang – any combination of power and communications
- Each gang accepts a duplex electrical receptacle or duplex mounting strap for communications connectors
- Complies with NEC 300-22(c) requirements for use in environmental air spaces
- Dimensions: 7.375" x 7.375", 3.5" min. floor height (top of raised floor to top of main floor surface)

3

2 and 3 Gang Access Floor Workstation Module Lid Replacement Kit

PART NUMBER 558717-X

X denotes color: -1 = Almond, -2 = Storm Gray, -3 = Black, -4 = NEMA Gray

Product Facts

- Can be easily field changed
- Available in 4 colors
- Kit shipped fully assembled

Concrete Form Boxes from Barthelmes Mfg. Co.



Product Facts

- Accept Access Floor Workstation Modules as listed
- Allows for installation of Access Floor Workstation Module in slab-on-grade applications
- AFWM boxes are purchased separately
- Contact:
Barthelmes Mfg. Co.
15 Cairn Street
Rochester, NY 14611-2491
Telephone: 585-328-8140
www.barthelmes.com

Accepts	OD (in Inches)	Barthelmes Part Number
4 & 5 Gang AFWMs	18" W x 18" D x 6.3" H	U135806
2 & 3 Gang AFWMs	18" W x 18" D x 6.3" H	U135820
4 Gang AFWMs	18" W x 18" D x 3.5" H	U135830
	18" W x 18" D x 2.75" H	U135840

NOTE: AFWM boxes are purchased separately.

Access Floor Workstation Modules (AFWM)

AFWM Flush Faceplates

Product Facts

- Include faceplate and mounting hardware
- For 3 and 5 Gang Access Floor Workstation Modules only
- 2-, 3-, and 4-port faceplates accept inserts for Modular Jack Panels and standard FLEX-MODE Faceplates

3

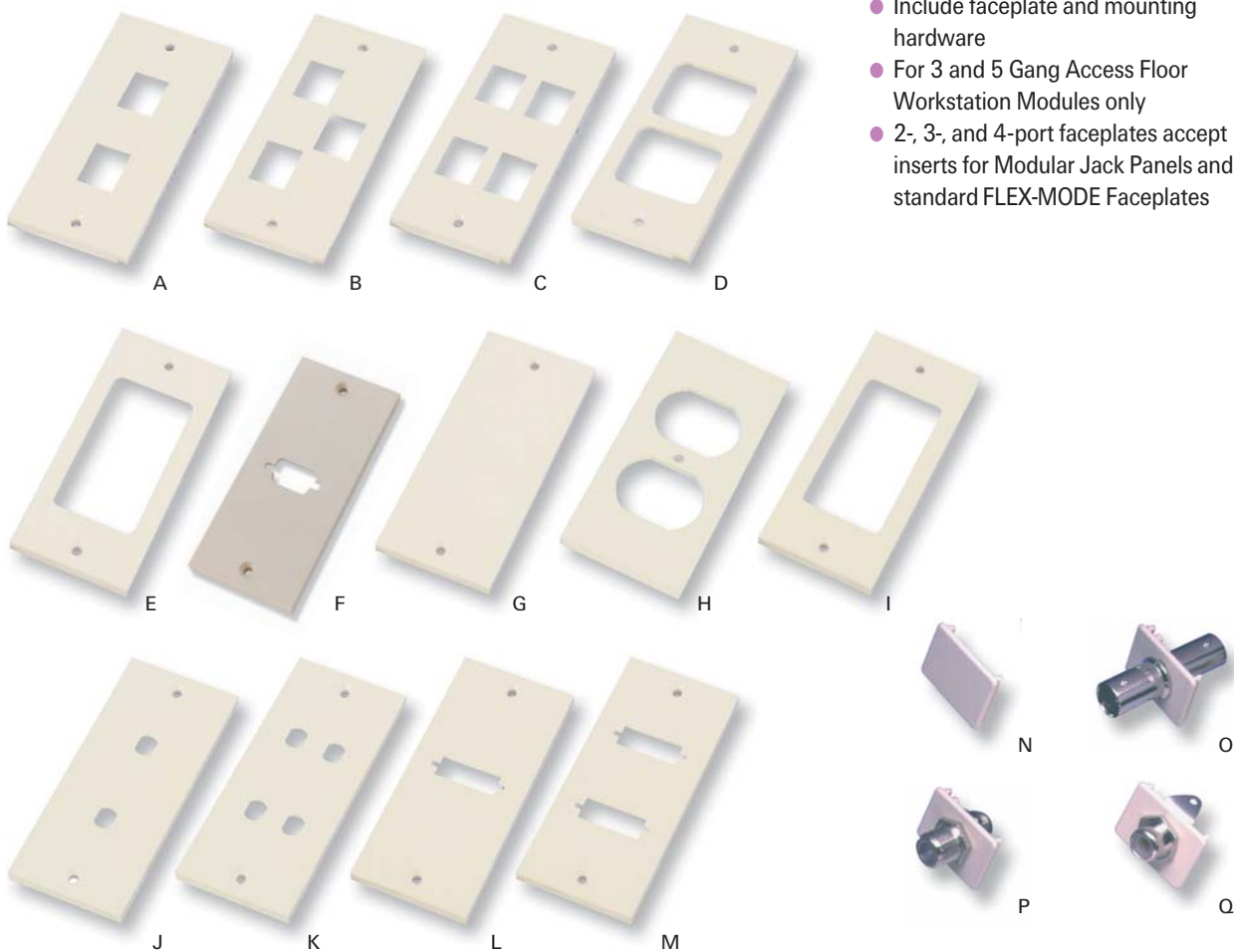

Description		Figure	Part Number
2-Port	Accepts two 110Connect, SL Series or MT-RJ Outlet Jacks	A	569916-X
3-Port	Accepts three 110Connect, SL Series or MT-RJ Outlet Jacks	B	569917-X
4-Port	Accepts four SL Series or MT-RJ Outlet Jacks	C	1116695-X
ACO	Accepts one dual-port low profile AMP Communications Outlet	D	769021-X
FLEX-MODE	Accepts one standard FLEX-MODE Module	E	769020-X
SVGA	Accepts one SVGA assembly (not included)	F	1499720-X
Blank	May also be cut or punched for custom mounting	G	557655-X
Power Receptacle Faceplates			
Standard	Accepts one "Double D" Duplex Receptacle or Duplex Mounting Strap	H	769028-X
Decorator	Accepts one Decorator-Style Receptacle or Decorator Mounting Strap	I	769016-X
Fiber Optic Faceplates (For MT-RJ Faceplates see A, B and C above.)			
2-Port ST	Includes two Multimode ST Couplers	J	557322-X
4-Port ST	Includes four Multimode ST Couplers	K	557474-X
Duplex SC	Accepts one Duplex SC Adapter	L	569646-X
Dual Duplex SC	Accepts two Duplex SC Adapters	M	569648-X
Inserts for Flush Faceplates (For use with A, B and C above.)			
Blank Insert	(Available in Black -1, or Almond-2)	N	558856-X
BNC	(Available in Black -1, or Almond-2)	O	558861-X
F-Connector	(Available in Black -1, or Almond-2)	P	558862-X
RCA Solder Type	(Available in Black -1, or Almond-2)	Q	569983-X

X denotes color: -1 = Almond, -2 = Storm Gray, -4 = NEMA Gray, -5 = White

187

Desktop Monuments

3

Desktop Monuments



A



B



C

Product Facts

- For additional SL Series Jacks see Chapter 2.2 and for FLEX-MODE Faceplates see this Chapter
- For RJ45 SECURE jacks, see Chapter 4
- Power Monuments:
 - Provide access to duplex power outlet at the desktop
 - Eliminates the need to feed power cables behind or through desks
 - Supplied with an 8 ft (2.4 m), 3-prong power cord for connection to existing electrical outlets
- Voice/Data Monuments:
 - Accepts standard FLEX-MODE Faceplates
 - Horizontal cabling can be connected directly to SL Series Modular Jacks (recommended for Category 5e applications)
- Attach to any desktop from 0.90" - 1.78" (22.9 mm - 45.2 mm)
- No special tools required to attach, simply place the monument onto the edge of the desktop and tighten the integrated thumb screw

Description/Color	Color	Figure	Part Number
Power Monument, 15 Amp	Gray	–	556222-1
	Black	A	556222-3
Category 3 Voice/Data Monument (includes two 6-position KEystone Jacks)	Gray	–	556263-1
	Gray	B	556263-2
Voice/Data Monument Empty Housing (requires FLEX-MODE Faceplate)	Gray	–	1116360-2
	Black	C	1116360-3

Modular Furniture Faceplate Kits

FLEX-MODE Modular Furniture Faceplate Kits



A

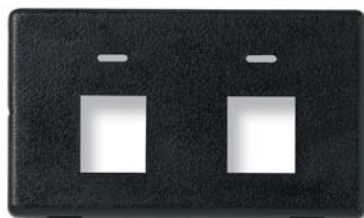

B

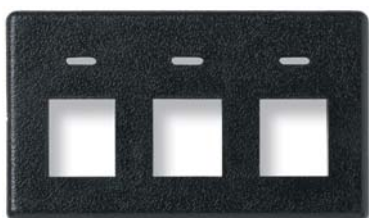

C



D



E

Product Facts

- FLEX-MODE Faceplates
 - Accept all SL Series Jacks, MT-RJ Outlet Jacks, 110Connect Jacks, or SL Series Multimedia Inserts and blanks
- 110Connect 4-Port Modules:
 - Printed circuit board assemblies include 4 jacks
 - Ideal for thin panels
- SL Series Faceplates:
 - Accepts up to 4 unshielded SL Series Jacks, MT-RJ Outlet Jacks and SL Series Multimedia Inserts
 - Patented "invisible" icon holes stay hidden until used
- Icons in Chapter 8

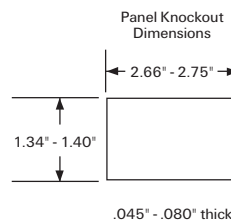

Description	Wiring	Figure	Part Number
Blank Plate		A	558471-X
FLEX-MODE Flush Faceplate	2-Port	B	558106-X
	3-Port	C	558107-X
110 Connect 4-Port Module	4-Port	Category 5e, T568A/T568B	1116580-X
SL Series	4-Port		1375288-X

X denotes color: -1 = Black, -2 = Almond, -4 = Gray

3

189

Modular Furniture Faceplate Kits

3

SL Series Furniture Outlets

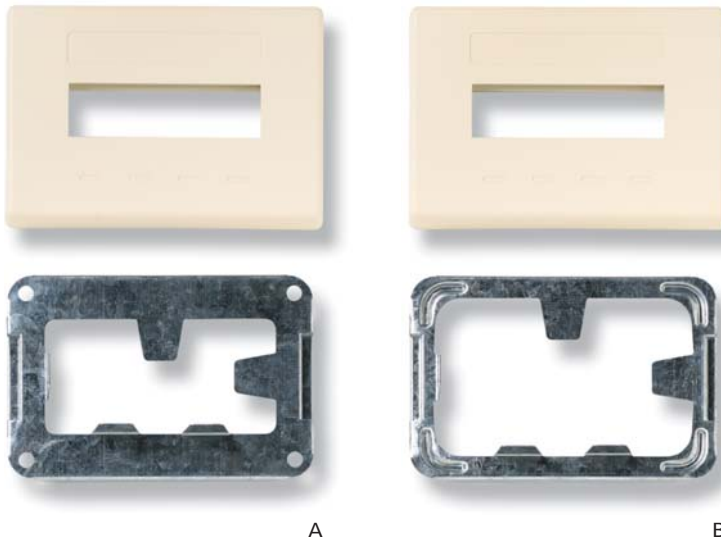

Description	Figure	Part Number
SL Series Furniture Outlet	Small opening	1375005-X
	Large opening	1375006-X

X denotes color: -1 = Almond, -2 = Black, -3 = White, -4 = Gray, 1--1 = Electrical Ivory

Product Facts

- Accepts up to 4 unshielded SL Series Jacks, MT-RJ Outlet Jacks and SL Series Multimedia Inserts
- Two bases adapt to a wide range of hole sizes
- Tabs on base fold over and crimp to furniture raceway cover
- "Invisible" icon holes stay hidden until used
- Icons in Chapter 8

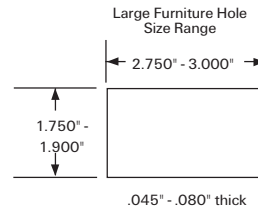
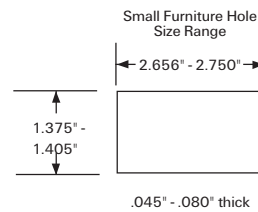

Flush Faceplate for HERMAN MILLER Furniture 4-Port

PART NUMBER 558357-X

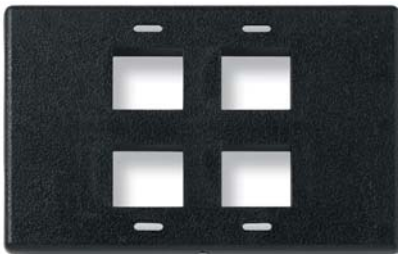

X denotes color: -1 = Black, -2 = Almond, -4 = Gray

Product Facts

- Accepts unshielded 110Connect Jacks and Multimedia Inserts, all SL Series Jacks and MT-RJ Outlet Jacks
- Jacks fit flush with front of faceplate
- No backup plate required
- Icons in Chapter 8

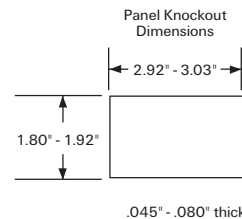

Modular Furniture Faceplate Kits & Accessories

Standard Faceplates for HERMAN MILLER Furniture



A



B

Description	Figure	Part Number
Standard Faceplate for 2-Port HERMAN MILLER Furniture	A	569127-X
Standard Faceplate for 4-Port HERMAN MILLER Furniture	B	558191-X

X denotes color: -1 = Black, -2 = Almond, -4 = Gray

Product Facts

- Accepts unshielded 110Connect Jacks, all SL Series Jacks, MT-RJ Outlet Jacks, and 110Connect and SL Series Multimedia Inserts
- May require backup plates depending on furniture style
- Icons in Chapter 8

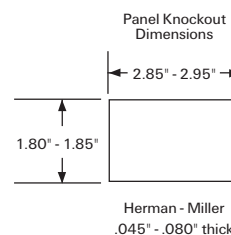

Extenders & Adapters for Furniture Faceplates



A



B

Description	Figure	Part Number
Standard Extender	A	558476-X
HERMAN MILLER Extender	A	558488-X
HERMAN MILLER Adapter	B	558493-X
KNOLL (Prior to 1992) Extender	A	558489-X*
KNOLL (Prior to 1992) Adapter	B	558492-X*

X denotes color: -1 = Black, -2 = Almond, -4 = Gray

*Note: Used to adapt standard FLEX-MODE Electrical faceplates to KNOLL furniture manufactured prior to 1992.

Product Facts

- Extenders:
 - Use when depth of furniture panel is limited
 - Raise outlet face approximately 3/4" above surface of raceway
- Adapters are used to adapt standard FLEX-MODE Electrical Faceplates to other hole sizes

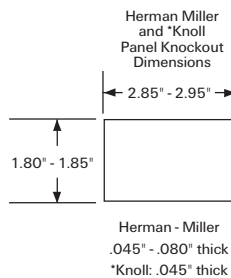
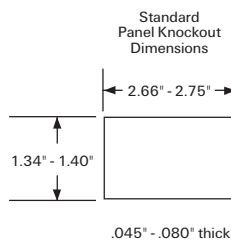

Modular Furniture Faceplate Accessories

FLEX-MODE Modular Furniture Faceplate Accessories

3



A



B



C



D

Description	For use with	Figure	Part Number
Backup Plate	WESTINGHOUSE Furniture	A	608046-1
	HERMAN MILLER ACTION OFFICE 2 and ETHOSPACE Furniture (1991 or later)	B	608440-1
	HERMAN MILLER SERIES 3 power opening	C	557751-1
Accessory Clip	HERMAN MILLER Furniture (before 1991)	D	608441-1

Twisted Pair Multi-User Outlets (MUO)

Mini Multi-User Outlet (MUO)



Description	Part Number
Category 5e, 6-Port Mini MUO	1479144-1
Category 6, 6-Port Mini MUO	1375376-1

Product Facts

- Provides a 6-port outlet particularly suited to open office or laboratory environments
- May be used free-hanging or mounted
- Available in Category 5e and Category 6 performance
- Meets TIA and ISO performance requirements
- Universal wiring – one part number may be terminated to T568A or T568B
- Suitable for use with either 4-pair or 25-pair cable
- Kits include housing, connector module and heat shrink tubing
- Replacement labels and clear label covers are available (see Chapter 8)

3

Category 5e Multi-User Outlet (MUO)

PART NUMBER 406810-1

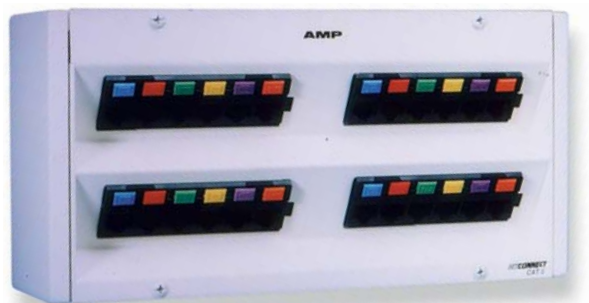

Product Facts

- Attaches to columns, walls or permanent furniture structures
- Connects directly to user communications equipment
- Accommodates surface raceway
- 24-port, Category 5e, 110Connect Jacks with angled cable exit

193

Optical Fiber Multi-User Outlets (MUO)

Optical Fiber Multi-User Outlet (MUO)

PART NUMBER 406817-1



Product Facts

- Attaches to columns, walls or permanent furniture structures
- Connects directly to user communications equipment
- Accommodates surface raceway
- Accepts two optical fiber modules shown below
- Cables exit flush to mounting surface

3

MUO Fiber Modules

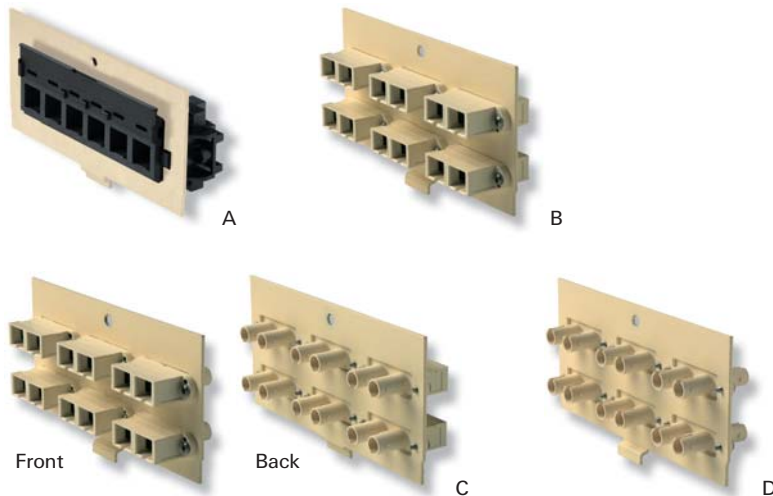

Product Facts

- SL Series Discrete Module:
 - Accepts up to six SL Series Jacks, MT-RJ Jacks or SL Series Inserts for custom configurations
- MT-RJ Jack Module holds up to six MT-RJ Outlet or Patch Panel Jacks (sold separately see chapter 2.2)
- 12-Fiber Duplex SC Module:
 - Suitable for multimode connectors
 - Couples SC Duplex or Simplex Connectors
- 12-Fiber Duplex SC to ST Module:
 - Suitable for multimode connectors
 - Couples SC Duplex or Simplex Connectors to ST Connectors
- 12-Fiber Dual ST Module:
 - Suitable for multimode connectors
 - Couples ST Connectors

Description		Figure	Part Number
	SL Series Discrete	–	1479204-1
	MT-RJ Jack	A	1375347-1
Optical Fiber Module	12-Fiber	Duplex SC	406818-1
		Duplex SC to ST	406819-1
		Dual ST	406820-1

Consolidation Points for Drop Ceiling Systems

Consolidation Points for Drop Ceiling Systems



A



B



C

Product Facts

- Designed for use in 2 ft x 2 ft ceiling tile grid systems
- Passive consolidation points accommodate standard 19-inch patch panels, cable management panels or 300-Pair cross-connects (see Chapter 1.5) as listed
- Active consolidation points accommodate 2U of active LAN equipment in addition to same passive components as the passive consolidation point 1479040
- Complies with NEC 300-22 (c) requirements for use in environmental air spaces
- Allows moves, adds and changes without re-terminating and re-testing cable
- Forms an interconnect between work area cabling and horizontal feeder cables
- Complies with TIA/EIA-568-B and ISO 11801:2002 requirements

3

Description	Total Capacity	Figure	Part Number
Passive Consolidation Points	5U (2U+1U+2U) for Passive Equipment	A	1479040-1
	Two 300-Pair Cross-Connect Blocks Without Legs	B	1479041-1
Active Consolidation Point	5U (2U+1U+2U) for Passive equipment, 2U (2U) for Active equipment	C	1479039-1

Consolidation Points for Raised Floor Systems

3

Consolidation Points for Raised Floor Systems

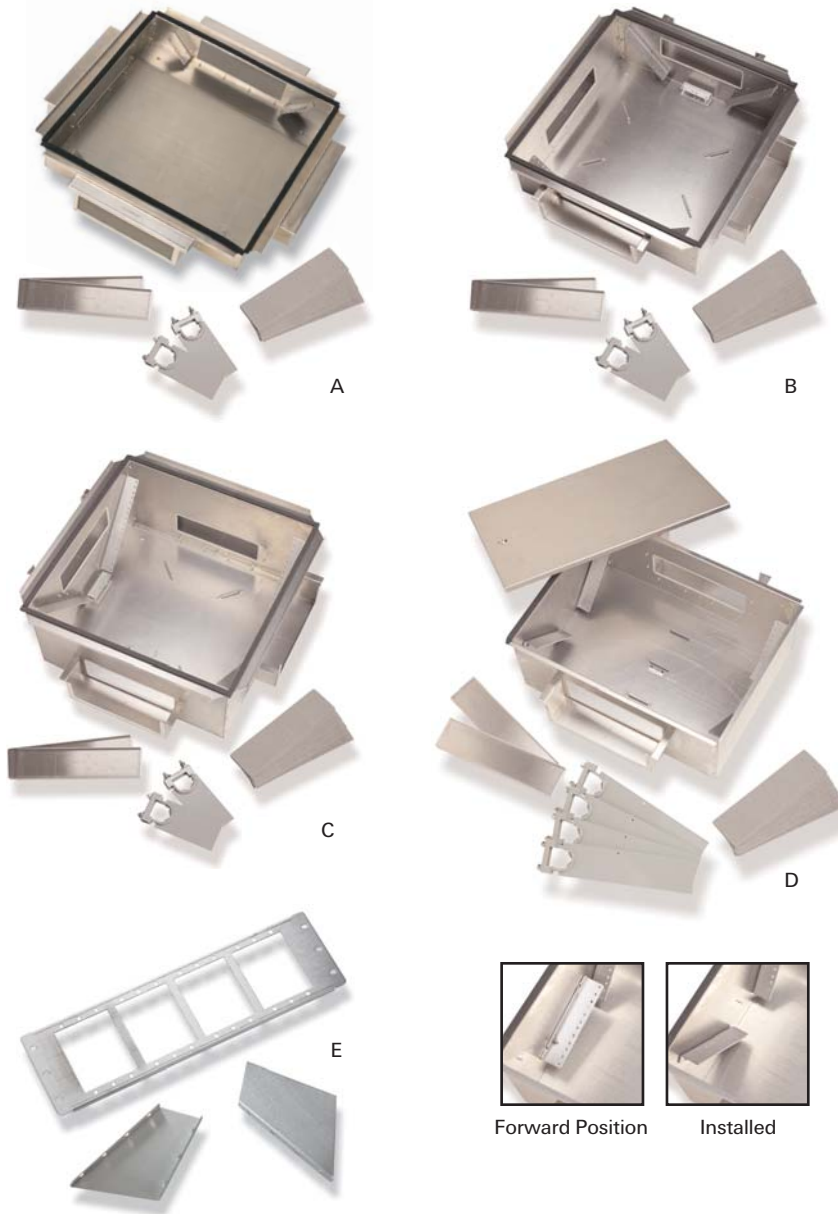

Product Facts

- Designed for use in 2 ft x 2 ft raised floor systems
- Accommodate standard 19" patch panels and/or cable management panels as listed
- Consolidation points for 2.5" high raised floor systems are designed to fit low profile raised floors
- Consolidation points for 10" high raised floor systems are intended for high density applications in data centers, server rooms, etc.
- Consolidation points for 6" – 10" high raised floor systems feature hinged patch panel mounts which allow easy access to patch panels for moves adds and changes
- Complies with NEC 300-22 (c) requirements for use in environmental air spaces
- Allows moves, adds and changes without re-terminating and re-testing cable
- Forms an interconnect between work area cabling and horizontal feeder cables
- Complies with TIA/EIA-568-B and ISO 11801:2002 requirements
- Fiber Support Bar is for use with Consolidation Points 1479359, 1479360, and 1479297
- Fiber Support Bar accepts Fiber Snap-in Adapter Plates or MPO Cassettes

Description	For Use With	Total Capacity	Figure	Part Number
Consolidation Points for Raised Floors	2.5" Raised Floors	2U (1U + 1U)	-	1479158-1
	6" Raised Floors	4U (2U + 2U)	A	1479042-1
	7" Raised Floors	8U (4U + 4U)	B	1479359-1
	10" Raised Floors	12U (6U + 6U)	C	1479360-1
Security Consolidation Point for Raised Floors	8" Raised Floors	8U (4U + 4U)	D	1479297-1
Fiber Support Bar Kit	for use with 1479359, 1479360, and 1479297	12 Adapter Plates or MPO Cassettes	E	1479326-1

Modular Consolidation Points and Accessories

Modular Consolidation Points



Description	Part Number
24-Port	406771-1
48-Port	1479322-1

Product Facts

- Modular consolidation points are designed for use in both raised floor and drop ceiling systems
- Allow moves, adds and changes without re-terminating and retesting cable
- Form an interconnect between work area cabling and horizontal feeder cables
- 24-Port accommodates four connector modules, 48-port accommodates eight
- Comply with TIA/EIA-568-B and ISO 11801 requirements
- Comply with NEC 300-22 (c) requirements for use in environmental air spaces
- Compliant with UL 2043 for use in environmental air spaces
- UL listed: file number E81956

3

6-Port Modular Jack Modules



Description	Part Number
Category 6	SL Series 1375367-1
Category 5e	110Connect 406772-1
Discrete	SL Series 1479696-1

Product Facts

- Comply with TIA/EIA-568-B and ISO 11801 requirements
- SL Series Discrete Module accepts up to six SL Series Jacks, MT-RJ Jacks or SL Series Inserts and allows for custom configurations
- SL Series Modules feature individually replaceable ports

197

12-Fiber Optical Fiber Modules

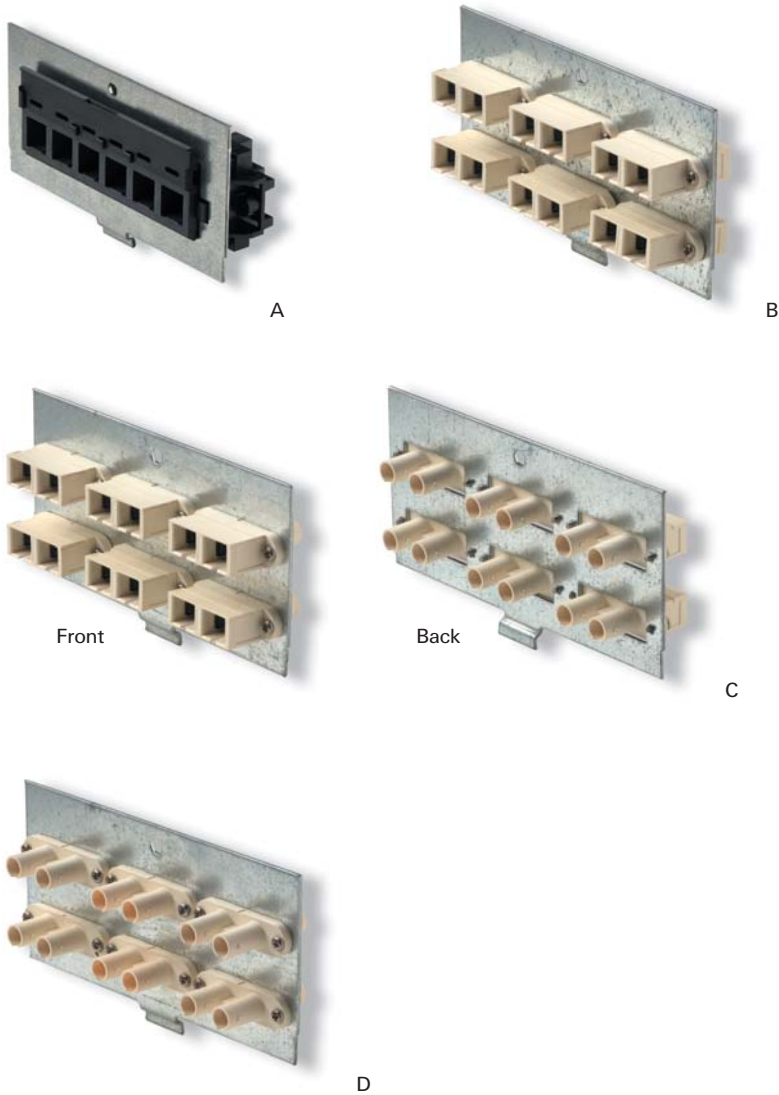

Product Facts

- Complies with TIA/EIA-568-B and ISO 11801 requirements
- MT-RJ Module holds up to six MT-RJ Patch Panel Jacks sold separately (see Chapter 2.2)
- SC and ST Modules suitable for multimode connectors

Description			Figure	Part Number
Multimode Modular Consolidation Point Modules	12-Fiber	MT-RJ Jack	A	1375093-1
		Duplex SC	B	406788-1
		Duplex SC to ST	C	406789-1
		Dual ST	D	406790-1

Cross-Connect Consolidation Point
PART NUMBER 406771-2

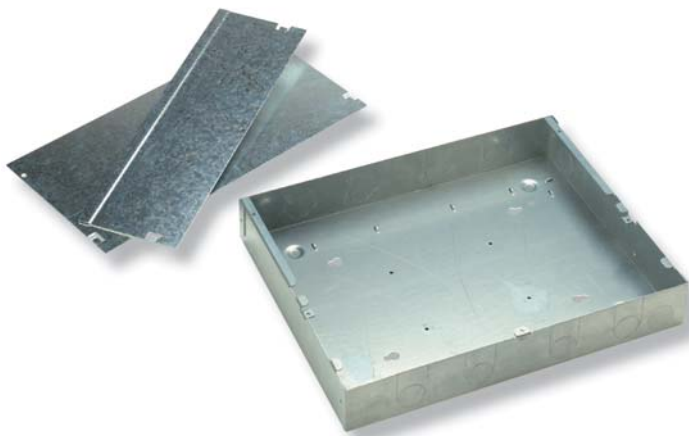

Product Facts

- Designed for use in both raised floor and drop ceiling systems
- Allows moves, adds and changes without re-terminating and retesting cable
- Forms an interconnect between work area cabling and horizontal feeder cables
- Complies with TIA/EIA-568-B and ISO 11801 requirements
- Accommodates two 100-Pair Category 6 610XC or 110Connect XC (see Chapter 1.5) Wiring Blocks
- Complies with NEC 300-22 (c) requirements for use in environmental air spaces
- Compliant with UL 2043 for use in environmental air spaces
- UL listed: file number E81956

3

Notes

3

200

SECURE SYSTEM PRODUCTS

MT-RJ SECURE Outlet Jacks	202
MT-RJ SECURE Patch Panel Jacks	203
MT-RJ SECURE Cable Assemblies	204
LC SECURE LightCrimp PLUS Connectors	205
LC SECURE Epoxy/Polish Connectors	206
LC SECURE SL Series Duplex Adapters and Adapter Plates	207
LC SECURE Cable Assemblies	208
MPO SECURE Trunk Cables	209
MPO SECURE Cassettes	210
RJ45 SECURE Products	211

Chapter Summary

- Color-coded, keyed designs to limit improper connections in segregated or secure networks
- SECURE plugs only mate with SECURE jacks or adapters of the same color
- Optical fiber and balanced twisted-pair copper SECURE systems products
- MT-RJ SECURE, LC SECURE, and MPO SECURE connectivity for optical fiber
- Shielded and unshielded RJ45 SECURE jacks and cable assemblies for balanced twisted-pair copper
- Additional SECURE products available, call (800) 522-6752 for details
- ROHS part numbers listed have the same fit, form and function as previous part numbers

4

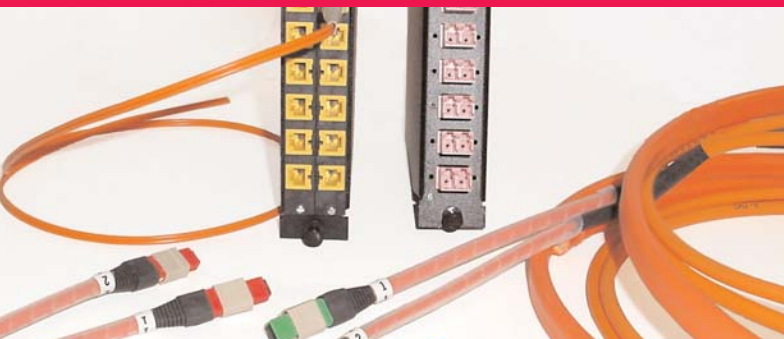

MT-RJ SECURE PRODUCTS

MT-RJ SECURE Outlet Jacks

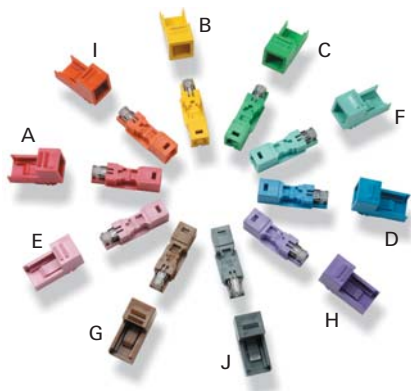

Easy 3-Step Termination



Product Facts

- Available in ten color-coded, keyed designs to limit improper connections in segregated or secure networks
 - MT-RJ SECURE plugs only mate with MT-RJ SECURE jacks of the same color
- Match cable fiber type to jack fiber type for correct part number
- Jack design eliminates need for MT-RJ SECURE adapter
- Small form factor design is half the size of SC duplex
- Terminate two 900 μm tight-buffered fibers in one outlet jack
 - No epoxy, no polishing, no crimping
 - Two fibers in one ferrule
 - Re-terminatable - improves yield
 - Each fiber is tunable and locked separately
 - No bench tool required
 - Same installation tools and procedures as non-secure MT-RJ jacks
- Each part number includes:
 - One (1) MT-RJ SECURE outlet jack
 - Actuation tool
 - SL Series housing in matching color
 - Bend-limiting boot (black)
- MT-RJ SECURE cable assemblies listed in this chapter
- Single-mode MT-RJ SECURE Jacks are available as pigtail assemblies. Call for details

Fiber Type	SECURE Jack Color	Housing Color	Figure	Part Number
50/125 μm Terminates two 900 μm Tight-buffered Fibers	RED	RED	A	6278811-1
	YELLOW	YELLOW	B	6278811-2
	GREEN	GREEN	C	6278811-3
	BLUE	BLUE	D	6278811-4
	ROSE	ROSE	E	6278811-5
	AQUA	AQUA	F	6278811-6
	BROWN	BROWN	G	6278811-7
	VIOLET	VIOLET	H	6278811-8
	ORANGE	ORANGE	I	6278811-9
	SLATE	SLATE	J	1-6278811-0
XG (850nm LO 50/125 μm) Terminates two 900 μm Tight-buffered Fibers	RED	RED	A	6754252-1
	YELLOW	YELLOW	B	6754252-2
	GREEN	GREEN	C	6754252-3
	BLUE	BLUE	D	6754252-4
	ROSE	ROSE	E	6754252-5
	AQUA	AQUA	F	6754252-6
	BROWN	BROWN	G	6754252-7
	VIOLET	VIOLET	H	6754252-8
	ORANGE	ORANGE	I	6754252-9
	SLATE	SLATE	J	1-6754252-0
62.5/125 μm Terminates two 900 μm Tight-buffered Fibers	RED	RED	A	6278810-1
	YELLOW	YELLOW	B	6278810-2
	GREEN	GREEN	C	6278810-3
	BLUE	BLUE	D	6278810-4
	ROSE	ROSE	E	6278810-5
	AQUA	AQUA	F	6278810-6
	BROWN	BROWN	G	6278810-7
	VIOLET	VIOLET	H	6278810-8
	ORANGE	ORANGE	I	6278810-9
	SLATE	SLATE	J	1-6278810-0

MT-RJ SECURE PRODUCTS

MT-RJ SECURE Patch Panel Jacks

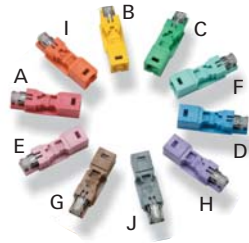

Easy 3-Step Termination



Product Facts

- Available in ten color-coded, keyed designs to limit improper connections in segregated or secure networks
 - MT-RJ SECURE plugs only mate with MT-RJ SECURE jacks of the same color
- Match cable fiber type to jack fiber type for correct part number
- Jack design eliminates need for MT-RJ SECURE adapter
- Small form factor design is half the size of SC duplex
- Each patch panel jack terminates either two 900um tight-buffered fibers or two 250um coated fibers (select appropriate part number):
 - No epoxy, no polishing, no crimping
 - Two fibers in one ferrule
 - Re-terminatable - improves yield
 - Each fiber is tunable and locked separately
 - No bench tool required
 - Same installation tools and procedures as non-secure MT-RJ jacks
- Each part number includes: Six (6) MT-RJ SECURE patch panel jacks, two (2) actuation tools, fiber guide, icon wheel
 - Single-mode Pigtail Jacks sold individually.
- Six (6) patch panel jacks fit in one MT-RJ). Snap-in Adapter Plate (sold separately
- SL Series housings and bend-limiting boots sold separately

Fiber Type	SECURE Jack Color	Figure	Part Number	
			250 μ m Coated Fiber	900 μ m Tight-buffered Fiber
50/125 μ m	RED	A	1278807-1	6588879-1
	YELLOW	B	1278807-2	6588879-2
	GREEN	C	1278807-3	6588879-3
	BLUE	D	1278807-4	6588879-4
	ROSE	E	1278807-5	6588879-5
	AQUA	F	1278807-6	6588879-6
	BROWN	G	1278807-7	6588879-7
	VIOLET	H	1278807-8	6588879-8
	ORANGE	I	1278807-9	6588879-9
	SLATE	J	1-1278807-0	1-6588879-0
	XG (850 nm LO 50/125 μ m)	RED	A	1693951-1
YELLOW		B	1693951-2	6693949-2
GREEN		C	1693951-3	6693949-3
BLUE		D	1693951-4	6693949-4
ROSE		E	1693951-5	6693949-5
AQUA		F	1693951-6	6693949-6
BROWN		G	1693951-7	6693949-7
VIOLET		H	1693951-8	6693949-8
ORANGE		I	1693951-9	6693949-9
SLATE		J	1-1693951-0	1-6693949-0
62.5/125 μ m		RED	A	1278808-1
	YELLOW	B	1278808-2	6588878-2
	GREEN	C	1278808-3	6588878-3
	BLUE	D	1278808-4	6588878-4
	ROSE	E	1278808-5	6588878-5
	AQUA	F	1278808-6	6588878-6
	BROWN	G	1278808-7	6588878-7
	VIOLET	H	1278808-8	6588878-8
	ORANGE	I	1278808-9	6588878-9
	SLATE	J	1-1278808-0	1-6588878-0
	Single-mode Pigtail Jacks (for fusion or mechanical splicing) Two 250 μ m fibers in on one protective 900 μ m tube	RED	-	-
YELLOW		-	-	6588569-X
GREEN		-	-	6588571-X
BLUE		-	-	6588570-X
ROSE		-	-	6828237-X
AQUA		-	-	6828238-X
BROWN		-	-	6828234-X
VIOLET		-	-	6828236-X
ORANGE		-	-	6828233-X
SLATE		-	-	6828235-X

X denotes length in meters: -1 = 1, -2 = 2, -3 = 3
Single-mode Pigtail Jacks can be spliced to either 250 μ m coated or 900 μ m tight-buffered fibers.

Multimode MT-RJ SECURE pigtail jacks are also available - call for details.

MT-RJ SECURE Cable Assemblies

MT-RJ SECURE Hybrid Cable Assemblies with MT-RJ, LC, SC and ST type connectors



Product Facts

- Connects to equipment with standard MT-RJ, LC, SC, and ST Interfaces
- Available in ten color-coded, keyed designs to limit improper connections in segregated or secure networks plugs only mate with similar type SECURE jacks of the same color
- MT-RJ SECURE assemblies do not have a SECURE MT-RJ, LC, SC or ST connectors on the other end
 - Other constructions and combinations are available - call for details
- Quick Turn / Ship capability for MT-RJ SECURE cable assemblies
- Each MT-RJ and MT-RJ SECURE connector houses two fibers
- Standard jacket color is yellow for single-mode, orange for 50/125 μm and 62.5/125 μm, and aqua for XG 50/125 μm
- Cable assemblies are riser-rated (Other ratings are available - call for details)

4

MT-RJ SECURE Color		MT-RJ	LC Duplex	SC Duplex	ST Dual
RED	50/125 μm Multimode	6278873-X	1907396-X	6278126-X	6278881-X
	XG (850 nm 50/125 μm) Multimode	6754406-X	1918667-X	6754410-X	1918701-X
	62.5/125 μm Multimode	6278890-X	6828104-X	6278894-X	6278898-X
	Single-mode	6918733-X	1918668-X	6918734-X	1918702-X
YELLOW	50/125 μm Multimode	6278874-X	1918669-X	6278878-X	6278882-X
	XG (850 nm 50/125 μm) Multimode	6754407-X	1918670-X	6754411-X	1918703-X
	62.5/125 μm Multimode	6278891-X	6828923-X	6278895-X	6278899-X
	Single-mode	6918735-X	1918671-X	6918736-X	1918704-X
GREEN	50/125 μm Multimode	6278875-X	1907398-X	6278879-X	6278883-X
	XG (850 nm 50/125 μm) Multimode	6754408-X	1918672-X	6754412-X	1918705-X
	62.5/125 μm Multimode	6278892-X	1918673-X	6278896-X	6278900-X
	Single-mode	6918737-X	1918674-X	6918738-X	1918706-X
BLUE	50/125 μm Multimode	6278876-X	1907394-X	6278880-X	6278884-X
	XG (850 nm 50/12 5μm) Multimode	6754409-X	1918675-X	6754413-X	1918707-X
	62.5/125 μm Multimode	6278893-X	1907395-X	6278897-X	6278901-X
	Single-mode	6918739-X	1918676-X	6918740-X	1918708-X
ORANGE	50/125 μm Multimode	6828263-X	1918677-X	6828269-X	1918709-X
	XG (850 nm 50/125 μm) Multimode	6828251-X	1918678-X	6828257-X	1918710-X
	62.5/125 μm Multimode	6828275-X	1918679-X	6828281-X	1918711-X
	Single-mode	6828239-X	1918680-X	6828245-X	1918712-X
BROWN	50/125 μm Multimode	6828264-X	1918681-X	6828270-X	1918713-X
	XG (850 nm 50/125 μm) Multimode	6828252-X	1918682-X	6828258-X	1918714-X
	62.5/125 μm Multimode	6828276-X	1918683-X	6828282-X	1918715-X
	Single-mode	6828240-X	1918684-X	6828246-X	1918716-X
SLATE	50/125 μm Multimode	6828265-X	1918685-X	6828271-X	1918717-X
	XG (850 nm 50/125 μm) Multimode	6828253-X	1918686-X	6828259-X	1918718-X
	62.5/125 μm Multimode	6828277-X	1918687-X	6828283-X	1918719-X
	Single-mode	6828241-X	1918688-X	6828247-X	1918720-X
VIOLET	50/125 μm Multimode	6828266-X	1918689-X	6828272-X	1918721-X
	XG (850 nm 50/125 μm) Multimode	6828254-X	1918690-X	6828260-X	1918722-X
	62.5/125 μm Multimode	6828278-X	1918691-X	6828284-X	1918723-X
	Single-mode	6828242-X	1918692-X	6828248-X	1918724-X
ROSE	50/125 μm Multimode	6828267-X	1918693-X	6828273-X	1918725-X
	XG (850 nm 50/125 μm) Multimode	6828255-X	1918694-X	6828261-X	1918726-X
	62.5/125 μm Multimode	6828279-X	1918695-X	6828285-X	1918727-X
	Single-mode	6828243-X	1918696-X	6828249-X	1918728-X
AQUA	50/125 μm Multimode	6828268-X	1918697-X	6828274-X	1918729-X
	XG (850 nm 50/125 μm) Multimode	6828256-X	1918698-X	6828262-X	1918730-X
	62.5/125 μm Multimode	6828280-X	1918699-X	6828286-X	1918731-X
	Single-mode	6828244-X	1918700-X	6828250-X	1918732-X

X denotes length in meters: -1 = 1, -2 = 2, -3 = 3, -5 = 5, 1- = 0 = 10

204

LC SECURE LightCrimp PLUS Connectors (No-epoxy/No-polish)



Product Facts

- Available in ten color-coded, keyed designs to limit improper connections in segregated or secure networks
- LC SECURE connectors only mate with LC SECURE adapters of the same color
- Match cable fiber type to jack fiber type for correct part number
- Terminate one 900um tight-buffered fiber or one 250um in one connector
 - No epoxy, no polishing
 - No bench tool required
 - Same installation tools and procedures as non-secure LC connectors
- LC SECURE LightCrimp PLUS connectors feature ceramic ferrules
- Duplex clip (black, sold separately) attaches two simplex connectors into duplex form and allows for polarity correction after termination
- 50/125 μm connectors come with black boots
- XG (850 nm LO 50/125 μm) connectors come with aqua boots
- 62.5/125 μm connectors come with beige boots
- Single-mode connectors come with blue boots
- LC SECURE LightCrimp PLUS connector termination uses the same LC LightCrimp PLUS connector installation tooling as standard LC

4

LC SECURE LightCrimp PLUS Connectors

Color	Simplex 50/125um SECURE	Simplex XG 50/125 um SECURE	Simplex 62.5/125 um SECURE	Simplex Single-mode SECURE
Red	1828853-1	1828854-1	1828855-1	1828856-1
Yellow	1828853-2	1828854-2	1828855-2	1828856-2
Green	1828853-3	1828854-3	1828855-3	1828856-3
Blue	1828853-4	1828854-4	1828855-4	1828856-4
Rose	1828853-5	1828854-5	1828855-5	1828856-5
Aqua	1828853-6	1828854-6	1828855-6	1828856-6
Brown	1828853-7	1828854-7	1828855-7	1828856-7
Violet	1828853-8	1828854-8	1828855-8	1828856-8
Orange	1828853-9	1828854-9	1828855-9	1828856-9
Slate	1-1828853-0	1-1828854-0	1-1828855-0	1-1828856-0

LC Duplex Clip Part Number 1754371-2



Product Facts

- Used to link two simplex LC connectors to make one duplex LC connector
- Compatible with single-mode or multimode simplex connectors
- Black
- Available in packages of six (6)

205

LC SECURE Epoxy/Polish Connectors



Product Facts

- Available in ten color-coded, keyed designs to limit improper connections in segregated or secure networks
- LC SECURE connectors only mate with LC SECURE adapters of the same color
- Duplex clip (black, sold separately) attaches two simplex connectors into duplex form and allows for polarity correction after termination
- Two LC SECURE connector kits for each fiber type (multimode and single-mode)
 - One terminates either one 250 μm coated fiber or one 900um tight-buffered fiber
 - One terminates one 1.6mm to 2.0mm jacketed
- Multimode connectors are suitable for use with 50/125 μm, XG (850 nm LO 50/125 μm), and 62.5/125 μm fibers and come with beige boots
- Single-mode connectors are suitable for use with all single-mode fiber types and come with blue boots
- LC SECURE connectors uses the same LC installation tooling as standard LC
- Suitable for use with heat-cured or anaerobic (quick cure) adhesive

4

Simplex LC SECURE Epoxy/Polish Connectors

Color	Multimode Terminates one 1.6 to 2.0mm Jacketed Fiber	Single-mode Terminates one 1.6 to 2.0mm Jacketed Fiber	Multimode Terminates one 250um coated and 900um buffer	Single-mode Terminates one 250um coated and 900um buffer
Red	1828078-1	1828079-1	1828861-1	1828862-1
Yellow	1828078-2	1828079-2	1828861-2	1828862-2
Green	1828078-3	1828079-3	1828861-3	1828862-3
Blue	1828078-4	1828079-4	1828861-4	1828862-4
Rose	1828078-5	1828079-5	1828861-5	1828862-5
Aqua	1828078-6	1828079-6	1828861-6	1828862-6
Brown	1828078-7	1828079-7	1828861-7	1828862-7
Violet	1828078-8	1828079-8	1828861-8	1828862-8
Orange	1828078-9	1828079-9	1828861-9	1828862-9
Slate	1-1828078-0	1-1828079-0	1-1828861-0	1-1828862-0

LC Duplex Clip Part Number 1754371-2



Product Facts

- Used to link two simplex LC connectors to make one duplex LC connector
- Compatible with single-mode or multimode simplex connectors
- Black
- Available in packages of six (6)

206

LC SECURE SL Series Duplex Couplers

Description	Fiber Type	Part Number
LC SECURE Coupler	Multimode & Single-mode	1933422-X
LC SECURE Hybrid Coupler	Multimode & Single-mode	1933285-X

X denotes color of LC Coupler and SL Series Housing: -1 = Red, -2 = Yellow, -3 = Green, -4 = Blue, -5 = Rose, -6 = Aqua, -7 = Brown, -8 = Violet, -9 = Orange, 1--0 = Slate

Product Facts

- Available in ten color-coded, keyed designs to limit improper connections in segregated or secure networks
- LC SECURE connectors only mate with LC SECURE couplers of the same color
- Hybrid Coupler – mates LC SECURE connectors to standard connectors
 - LC SECURE coupler on the Work Area side
- Configure faceplates with one or more LC SECURE connectors to provide a common access point to multiple segregated or secure networks
- Couplers suitable for use with multimode and single-mode LC SECURE connectors
- Easily snaps into SL Series modules, duplex mounting straps, patch panels and enclosures
- May be used in straight or angled faceplate modules

24-Fiber LC SECURE Snap-in Adapter Plates

Product Facts

- Available in ten color-coded, keyed designs to limit improper connections in segregated or secure networks
- LC SECURE connectors only mate with LC SECURE adapters of the same color
- Adapters suitable for use with multimode or single-mode LC SECURE connectors
- Snap-in Adapter Plates fit in unloaded optical fiber enclosures listed in chapters 2.5 and 2.6
- Each snap-in adapter plate holds twelve (12) duplex LC SECURE adapters
- Configure enclosures with one or more LC SECURE variant adapter plates

Description	Adaptor Color	Package Qty	Part Number
Duplex LC SECURE Snap-in Adaptor plates	Red	1	1499702-2
	Yellow	1	1499703-2
	Green	1	1499704-2
	Blue	1	1499705-2
	Rose	1	1499706-2
	Aqua	1	1499707-2
	Brown	1	1499708-2
	Violet	1	1499709-2
	Orange	1	1499710-2
	Slate	1	1499711-2

LC SECURE Cable Assemblies

LC SECURE Duplex Hybrid Cable Assemblies with MT-RJ, LC, SC, and ST type connectors



Product Facts

- Connects to equipment with standard MT-RJ, LC, SC, and ST interfaces
- Available in ten color-coded, keyed designs to limit improper connections in segregated or secure networks
- LC SECURE plugs only mate with LC SECURE adapters of the same color
- LC SECURE Duplex assemblies do not have a SECURE MT-RJ, LC, SC or ST connectors on the other end
 - Other constructions and combinations are available - call for details
 - Quick Turn Quick Ship available
- LC SECURE connectors feature ceramic ferrules
- Standard jacket color is yellow for single-mode, orange for 50/125 μm and 62.5/125 μm, and aqua for XG 50/125 μm
- Cable assemblies are riser-rated
- Other ratings are available - call for details

4

LC SECURE Duplex Color		MT-RJ	LC Duplex	SC Duplex	ST Dual
RED	50/125 μm Multimode	1907114-X	1906012-X	1905992-X	1906002-X
	XG (850 nm 50/125 μm) Multimode	1907134-X	1906090-X	1906070-X	1905079-X
	62.5/125 μm Multimode	1907124-X	1906051-X	1828872-X	1906080-X
	Single-mode	1906904-X	1905109-X	1905089-X	1905099-X
YELLOW	50/125 μm Multimode	1907116-X	1906014-X	1905994-X	1906004-X
	XG (850 nm 50/125 μm) Multimode	1907136-X	1906092-X	1906072-X	1906082-X
	62.5/125 μm Multimode	1907126-X	1906053-X	1828871-X	1906043-X
	Single-mode	1906906-X	1905111-X	1905091-X	1905101-X
GREEN	50/125 μm Multimode	1907117-X	1906015-X	1905995-X	1906005-X
	XG (850 nm 50/125 μm) Multimode	1907137-X	1906093-X	1906073-X	1906083-X
	62.5/125 μm Multimode	1907127-X	1906054-X	1828870-X	1906044-X
	Single-mode	1906907-X	1905112-X	1905092-X	1905102-X
BLUE	50/125 μm Multimode	1907115-X	1906013-X	1905993-X	1906003-X
	XG (850 nm 50/125 μm) Multimode	1907135-X	1906091-X	1906071-X	1906081-X
	62.5/125 μm Multimode	1907125-X	1906052-X	1828875-X	1906042-X
	Single-mode	1906905-X	1905110-X	1905090-X	1905100-X
ORANGE	50/125 μm Multimode	1907118-X	1906016-X	1906996-X	1906006-X
	XG (850 nm 50/125 μm) Multimode	1907138-X	1906094-X	1906074-X	1906084-X
	62.5/125 μm Multimode	1907128-X	1906055-X	1906035-X	1906045-X
	Single-mode	1906908-X	1905113-X	1905093-X	1905103-X
BROWN	50/125 μm Multimode	1907121-X	1906019-X	1906999-X	1906009-X
	XG (850 nm 50/125 μm) Multimode	1907141-X	1906097-X	1906077-X	1906087-X
	62.5/125 μm Multimode	1907131-X	1906058-X	1906038-X	1906048-X
	Single-mode	1906911-X	1905116-X	1905096-X	1905106-X
SLATE	50/125 μm Multimode	1907123-X	1906021-X	1906001-X	1906011-X
	XG (850 nm 50/125 μm) Multimode	1907143-X	1906099-X	1906079-X	1906089-X
	62.5/125 μm Multimode	1907133-X	1906060-X	1828283-X	1906050-X
	Single-mode	1906913-X	1905118-X	1906040-X	1905108-X
VIOLET	50/125 μm Multimode	1907120-X	1906018-X	1905998-X	1906008-X
	XG (850 nm 50/125 μm) Multimode	1907140-X	1906096-X	1906076-X	1906086-X
	62.5/125 μm Multimode	1907130-X	1906057-X	1906037-X	1906047-X
	Single-mode	1906910-X	1905115-X	1905095-X	1905105-X
ROSE	50/125 μm Multimode	1907119-X	1906017-X	1905997-X	1906007-X
	XG (850 nm 50/125 μm) Multimode	1907139-X	1906095-X	1906075-X	1906085-X
	62.5/125 μm Multimode	1907129-X	1906056-X	1906036-X	1906046-X
	Single-mode	1906909-X	1905114-X	1905094-X	1905104-X
AQUA	50/125 μm Multimode	1907122-X	1906020-X	1906000-X	1906010-X
	XG (850 nm 50/125 μm) Multimode	1907142-X	1906098-X	1906078-X	1906088-X
	62.5/125 μm Multimode	1907132-X	1906059-X	1906039-X	1906049-X
	Single-mode	1906912-X	1905117-X	1905097-X	1905107-X

X denotes length in meters: -1 = 1, -2 = 2, -3 = 3, -5 = 5, 1-0 = 10

208

MPO SECURE Trunk Cable Assemblies

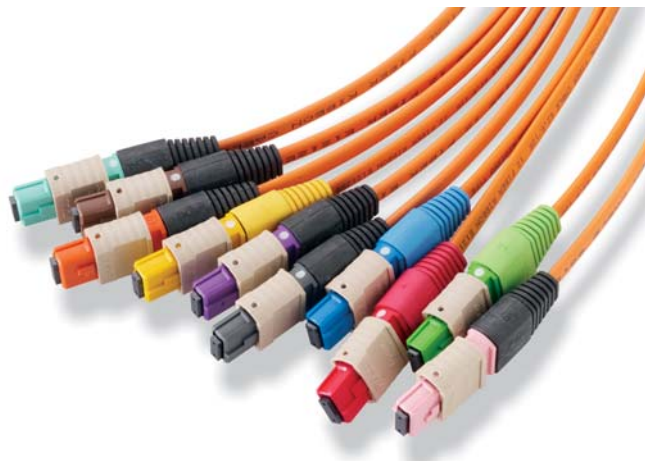

Product Facts

- MPO SECURE plugs available in ten color-coded, keyed designs to limit improper connections in segregated or secure networks
 - MPO SECURE plugs only mate with MPO SECURE adapters of the same color
- Twelve (12) fibers per MPO SECURE plug
- Easy installation - MPO SECURE plugs are push/pull connectors
- Trunk cables come pre-tested and ready for immediate use with MPO SECURE plugs on both ends
- Pulling socks protect MPO SECURE terminations during installation
- Trunk cable fiber polarity is Pair-Flipped (AB/BA)
 - Trunk cables with straight-through polarity (AB/AB) are available call for details
- MPO SECURE trunk cables are plenum cables
 - Plenum cables can be used in riser spaces
- Quick Turn Quick Ship capability for MPO SECURE cable assemblies
- Additional fiber counts and custom lengths are available - call for details

4

Description	Fiber Type	MPO SECURE Plug Color/Keying	Part Number			
			12-Fiber	24-Fiber		
MPO SECURE Trunk Cable Assemblies OFNP	50/125 μm	Red	6754273-X	6754281-X		
		Yellow	6754276-X	6754284-X		
		Green	6754274-X	6754282-X		
		Blue	6754275-X	6754283-X		
		Rose	1918741-X	1918759-X		
		Aqua	1918742-X	1918760-X		
		Brown	1918743-X	1918761-X		
		Violet	1918744-X	1918762-X		
		Orange	1918745-X	1918763-X		
		Slate	1918746-X	1918764-X		
		Red	6754420-X	6754424-X		
		Yellow	6754421-X	6754425-X		
		Green	6754422-X	6754426-X		
		Blue	6754423-X	6754427-X		
		Rose	1918753-X	1918771-X		
		Aqua	1918754-X	1918772-X		
		Brown	1918755-X	1918773-X		
		Violet	1918756-X	1918774-X		
	Orange	1918758-X	1918775-X			
	Slate	1918759-X	1918776-X			
	Red	6754269-X	6754277-X			
	Yellow	6754272-X	6754280-X			
	Green	6754270-X	6754278-X			
	Blue	6754271-X	6754279-X			
	Rose	1918747-X	1918765-X			
	Aqua	1918748-X	1918766-X			
	Brown	1918749-X	1918767-X			
	Violet	1918750-X	1918768-X			
	Orange	1918751-X	1918769-X			
	Slate	1918752-X	1918770-X			
		XG (850 nm LO 50/125 μm)				
	62.5/125 μm					

X denotes length in feet: -1 = 10, -2 = 20, -3 = 30, -4 = 40, -5 = 50, -6 = 60, -7 = 70, -8 = 80, -9 = 90, 1--0 = 100, 1--1 = 110, 1--2 = 120, 1--3 = 130, 1--4 = 140, 1--5 = 150, 1--6 = 160, 1--7 = 170, 1--8 = 180, 1--9 = 190, 2--0 = 200, 2--1 = 210, 2--2 = 220, 2--3 = 230, 2--4 = 240, 2--5 = 250, 2--6 = 260, 2--7 = 270, 2--8 = 280, 2--9 = 290, 3--0 = 300

209

MPO SECURE Optical Fiber Cassettes

4



Product Facts

- MPO SECURE cassettes available in ten color-coded, keyed designs to limit improper connections in segregated or secure networks
- MPO SECURE plugs only mate with MPO SECURE adapters of the same color
- Cassettes have one MPO SECURE connection (12-Fiber) or two MPO SECURE connections (24-Fiber) on the back
- Cassettes house one or two 12-fiber break-out assemblies
- MPO SECURE cassette color/variant matches the LC SECURE or MT-RJ SECURE adapter color/variant of the cassette
- Cassette fiber polarity is Pair-Flipped (AB/BA)
 - Cassettes with Pair-Straight polarity (AB/AB) are available - call for details
- Cassettes have same footprint as the snap-in adapter plates and fit in unloaded optical fiber enclosures
- Factory tested and ready for installation
- Quick Turn Quick Ship capability for MPO SECURE cassettes

Description	Fiber Type	Fiber Count	Duplex Port Count	Part Number	
				MT-RJ SECURE	LC SECURE
MPO SECURE Cassettes	50/125 μ m Multimode	12	6	1754286-X	1918779-X
		24	12	1754288-X	1918780-X
	XG (850 nm LO 50/125 μ m)	12	6	1918777-X	1918783-X
		24	12	1918778-X	1918784-X
	62.5/125 μ m Multimode	12	6	1754285-X	1918781-X
		24	12	1754287-X	1918782-X

X denotes cassette connector color: -2 = Red, -3 = Green, -4 = Blue, -5 = Yellow, -6 = Orange, -7 = Brown, -8 = Violet, -9 = Rose, 1 -- 0 = Slate, 1 -- 1 = Aqua

RJ45 SECURE SL Series Category 6 Modular Jacks

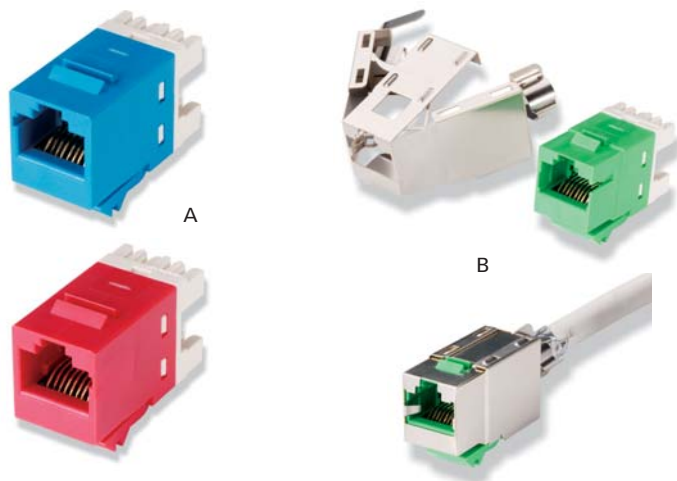

Wiring Pattern		Figure	Part Number
T568A/T568B	Unshielded	A	1479794-X
	Shielded 180° (Rear) Entry	B	1479795-X

X denotes color: -1 = Red, -2 = Yellow, -3 = Green, -4 = Blue, -8 = Violet, -9 = Orange

Product Facts

- RJ45 SECURE jacks available in six color-coded, keyed designs to limit improper connections in segregated or secure networks
 - RJ45 SECURE plugs only mate with RJ45 SECURE jacks of the same color
- Configure faceplates with one or more RJ45 SECURE connectors to provide a common access point to multiple segregated or secure networks
- Same thin profile as standard RJ45 SL Series jacks - easily snaps into SL Series modules, duplex mounting straps, patch panels and enclosures
- May be used in straight or angled faceplate modules
- 180° cable dress for easy termination
 - Unshielded jacks also allow 90° cable dress
- Universal wiring label permits wiring to T568A or T568B
- Bend-limiting strain relief included with unshielded jacks
- UL Listed: E81956
- 8-Position RJ45 SECURE Modular Jacks for 1-, 2-, 3- and 4-Pair applications
- Shielded and unshielded jacks
- Can be terminated with SL Series Modular Jack Termination Tool 1725150-1

Category 6 RJ45 SECURE Patch Cable Assemblies



Product Facts

- RJ45 SECURE assemblies available in six color-coded, keyed designs to limit improper connections in segregated or secure networks
 - RJ45 SECURE plugs only mate with RJ45 SECURE jacks of the same color
- RJ45 SECURE assemblies have a standard plug on one end and one RJ45 SECURE plug on the other
- Color-matched snagless boots
- Universal wiring (T568A/T568B)
- 26 AWG conductors
- Shielded and unshielded cable assemblies
- Cable assemblies are non-plenum (riser-rated)

Description	Part Number					
	Red	Yellow	Green	Blue	Violet	Orange
RJ45 SECURE Unshielded	1499841-X	1499842-X	1499843-X	1499844-X	1499845-X	1499846-X
RJ45 SECURE Shielded	1499848-X	1499849-X	1499850-X	1499851-X	1499852-X	1499853-X

X denotes length in feet: -2 = 2, -3 = 3, -4 = 4, -5 = 5, -6 = 6, -7 = 7, -8 = 8, -9 = 9, 1-0 = 10, 1-2 = 12, 1-4 = 14, 1-5 = 15, 1-6 = 16, 2-0 = 20, 2-5 = 25, 3-0 = 30, 4-0 = 40, 5-0 = 50

Notes

4

212

RACEWAY, VERTICAL AND HORIZONTAL RACK MANAGEMENT

Rack Management	214-217
Cabletray Raceway System	218-222
Finger Duct Panels	223
Management Panels	224
Cable Management Rings	225
Cable Support Bars	226
Cable Ties	227

Chapter Summary

- Tyco Electronics offers a comprehensive line of Cable Management products for surface, rack, and raised floor applications. If you have product needs beyond those listed in this catalog, please call the Tyco Electronics Product Information Center at 1-800-522-6752.



High Density Vertical Cable Management



Product Facts

- Two-piece doors with snap on hinges allow for quick opening from either side or complete removal
- Six snap-on gates retain cables when doors are opened or removed.
- Easy installation, can be done in minutes using standard hand tools.
- Works with EIA-310-D compliant two and four post equipment racks using industry standard mounting holes.
- 1/4" accessory mounting holes run the full height on both sides of cable manager to accommodate the attachment of cable management accessories.
- Separator panel with pass through openings, vertical slots for attaching straps and keyhole slots for attaching spools, included with each manager.
- Front and rear vertical sections can be spaced apart when mounting on racks deeper than 3" (76mm)
- Flat black powder coat aluminum with UL 94V-0 black plastic components
- Vertical cable manager includes:
 - Front and Rear vertical cabling section, (4) doors, (6) gates, (50) push-in fasteners, (12) cable strap mounts, Separator panel and mounting hardware.
 - On 10" and 12" wide cable managers only, (2) spool kits are included.

5

Double Sided Vertical Cable Managers



Our double-sided vertical cable managers with closely spaced fingers on the front and the rear and are designed for routing high density cabling on and between racks. These high capacity managers have access doors and gates for the front and rear.

- Standard (Std) Fingers have 1U Spacing Vertically and are 8.5" Deep
- Extended (Ext) Fingers have 1U Spacing Vertically and are 11" Deep

Description	Part Numbers
Vertical Mgr, 84", Double-sided, 6" W, Std Fingers Front and Rear	1933534-1
Vertical Mgr, 84", Double-sided, 10" W, Std Fingers Front and Rear	1933535-1
Vertical Mgr, 84", Double-sided, 12" W, Std Fingers Front and Rear	1933536-1
Vertical Mgr, 84", Double-sided, 6" W, Ext Fingers Front and Rear	1933537-1
Vertical Mgr, 84", Double-sided, 10" W, Ext Fingers Front and Rear	1933538-1
Vertical Mgr, 84", Double-sided, 12" W, Ext Fingers Front and Rear	1933539-1

Double-Sided Combination Vertical Cable Managers

Our double-sided combination vertical cable managers which have closely spaced fingers on the front, are designed for routing high density cabling on and between racks. The rear of these managers have open fingers for managing large cable bundles. These high capacity managers have access doors for the front and gates for the front and rear.



Product Facts

- Standard (Std) Fingers have 1U Spacing Vertically and are 8.5" Deep
- Extended (Ext) Fingers have 1U Spacing Vertically and are 11" Deep
- Open Fingers have 9U Spacing Vertically and are 8.5" Deep

Description	Part Numbers
Vertical Mgr, 84", Double-sided, 6" W, Std Fingers Front, Open Fingers rear	1933540-1
Vertical Mgr, 84", Double-sided, 10" W, Std Fingers Front, Open Fingers rear	1933541-1
Vertical Mgr, 84", Double-sided, 12" W, Std Fingers Front, Open Fingers rear	1933542-1
Vertical Mgr, 84", Double-sided, 6" W, Ext Fingers Front, Open Fingers Rear	1933543-1
Vertical Mgr, 84", Double-sided, 10" W, Ext Fingers Front, Open Fingers Rear	1933544-1
Vertical Mgr, 84", Double-sided, 12" W, Ext Fingers Front, Open Fingers Rear	1933545-1

5

Replacement Door Kits

Product Facts

- Kit includes an upper and lower door section
- Doors are for Double-Sided and Double-Sided Combination Vertical Managers

Description	Part Numbers
6" Replacement Door Kits	1933556-1
10" Replacement Door Kits	1933557-1
12" Replacement Door Kits	1933558-1

Side Cover Panel

Used to cover the side of the vertical cable manager at the end of a row

Description	Part Number
Side Cover Panel	1933563-1

Gate Kit



Product Facts

- Used on the rear of a Combination Manager when additional fingers are desired
- Gate kits are 2U high
- Kit includes (2) finger sections, (1) gate, and mounting hardware.
- UL 94V-0 black plastic components

Description	Part Numbers
Gate Kit - 6"	1933546-1
Gate Kit - 10"	1933547-1
Gate Kit - 12"	1933548-1

215

Replacement Gates



Product Facts

- Easy installation. Gates snap on and can be installed under doors
- Gates can be opened in either direction, and can be quickly removed for easy cable access.
- Includes (6) gates.
- UL 94V-0 black plastic

Description	Part Numbers
Replacement Gates, 6"	1933549-1
Replacement Gates, 10"	1933550-1
Replacement Gates, 12"	1933551-1

5

Finger Bracket



Description	Part Number
Finger Bracket	1933552-1

Product Facts

- High-density finger bracket mounts directly to a relay rack and provides cable support at each rack mounting unit
- Fingers align with rack mounting units
- Includes (1) finger bracket and mounting hardware
- Flat black powder coat aluminum bracket with UL 94V-0 black plastic finger section

Cable Spools



Description	Part Number
Cable Spools	1933553-1

Product Facts

- Spool provides 1.1" (28mm) bend radius
- Cable spools attach quickly to keyhole slots provided in mounting channels and optional back covers
- Facilitates storage and routing of cable
- Unique spool kit design provides for vertical and horizontal adjustability to suit any need.
- Spool kits includes (2) spools, mounting channels and hardware
- Flat black powder coat steel with UL 94V-0 black plastic

216

Fasteners

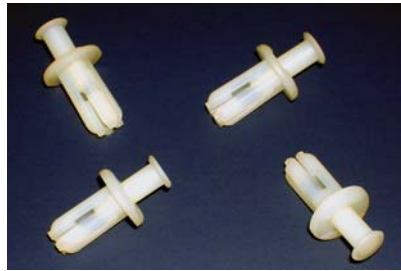

Description	Part Number
Fasteners	1933554-1

Product Facts

- Used to quickly attach accessories to 1/4" (6mm) mounting holes in cable manager.
- Can be easily removed for relocation.
- Standard pack: 100 pieces
- White Plastic UL 94V-2

Cable Strap Mounts



Description	Part Number
Cable Strap Mounts	1933555-1

Product Facts

- Provides attachment for cable straps up to 3/4" (19mm) wide.
- Attach with Push-in fastener 1933554-1 to 1/4" (6mm) accessory mounting holes in cable manager.
- Standard pack: 100 pieces
- Black Plastic UL 94V-0

5

Horizontal Management



Product Facts

- Snap-on removable hinged door remains open past 180°
- #12-24 mounting hardware is included.
- Flat black powder coat aluminum with UL 94V-0 black plastic components
- Standard Fingers are 5.5" Deep
- Extended Fingers are 8" Deep

Description	Part Numbers
Horizontal 1U, Single Sided, Standard Fingers	1933530-1
Horizontal 1U, Double Sided, Standard Fingers	1933531-1
Horizontal 2U, Single Sided, Standard Fingers	1933532-1
Horizontal 2U, Double Sided, Standard Fingers	1933533-1
Horizontal 3U, Single Sided, Standard Fingers	1933561-1
Horizontal 3U, Double Sided, Standard Fingers	1933562-1
Horizontal 1U, Single Sided, Extended Fingers	1933564-1
Horizontal 1U, Double Sided, Extended Fingers	1933565-1
Horizontal 2U, Single Sided, Extended Fingers	1933566-1
Horizontal 2U, Double Sided, Extended Fingers	1933567-1
Horizontal 3U, Single Sided, Extended Fingers	1933568-1
Horizontal 3U, Double Sided, Extended Fingers	1933569-1

217

Cabletray Raceway System

5

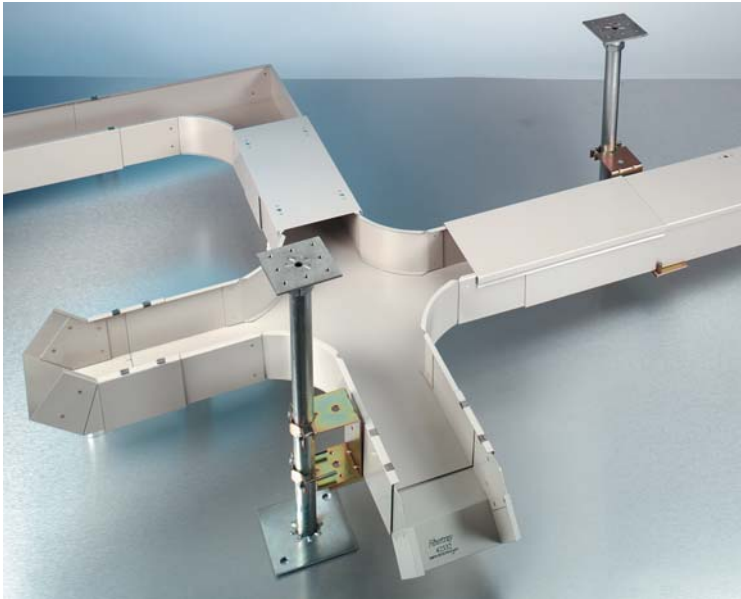

Product Facts

- Aluminum construction (unpainted)
- No cutting or bending required
- No specialized tools required
- No adhesives required
- No fasteners required for snap-on covers
- Solid base design protects cables from sagging
- User-defined layout (assistance available)
- UL approved (UL5)
- All turns and bends use a 2" minimum bend radius
- Telescoping connecting sections allow for complete adjustability
- Mounting techniques include support brackets for mounting:
 - directly to floor
 - to raised floor pedestals
 - to walls or ceiling hung
- IBM qualified and approved



218

Cabletray Raceway and Cover

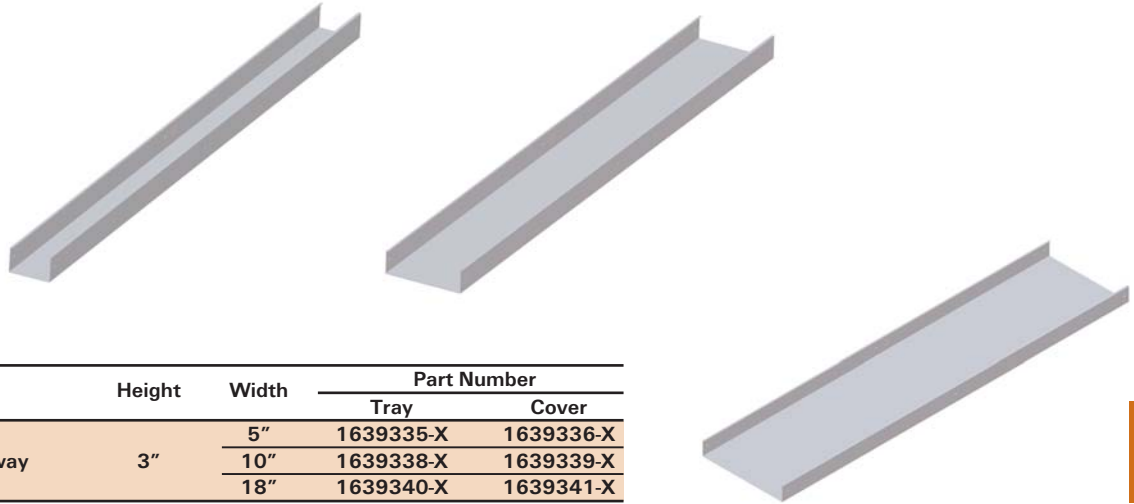

Description	Height	Width	Part Number	
			Tray	Cover
CableTray Raceway	3"	5"	1639335-X	1639336-X
		10"	1639338-X	1639339-X
		18"	1639340-X	1639341-X
FiberTray Raceway Vented	3"	5"	1639337-X	1639336-X

X denotes tray length in feet: -1 = 1, -2 = 2, -3 = 4, -4 = 6

5

Connecting Section

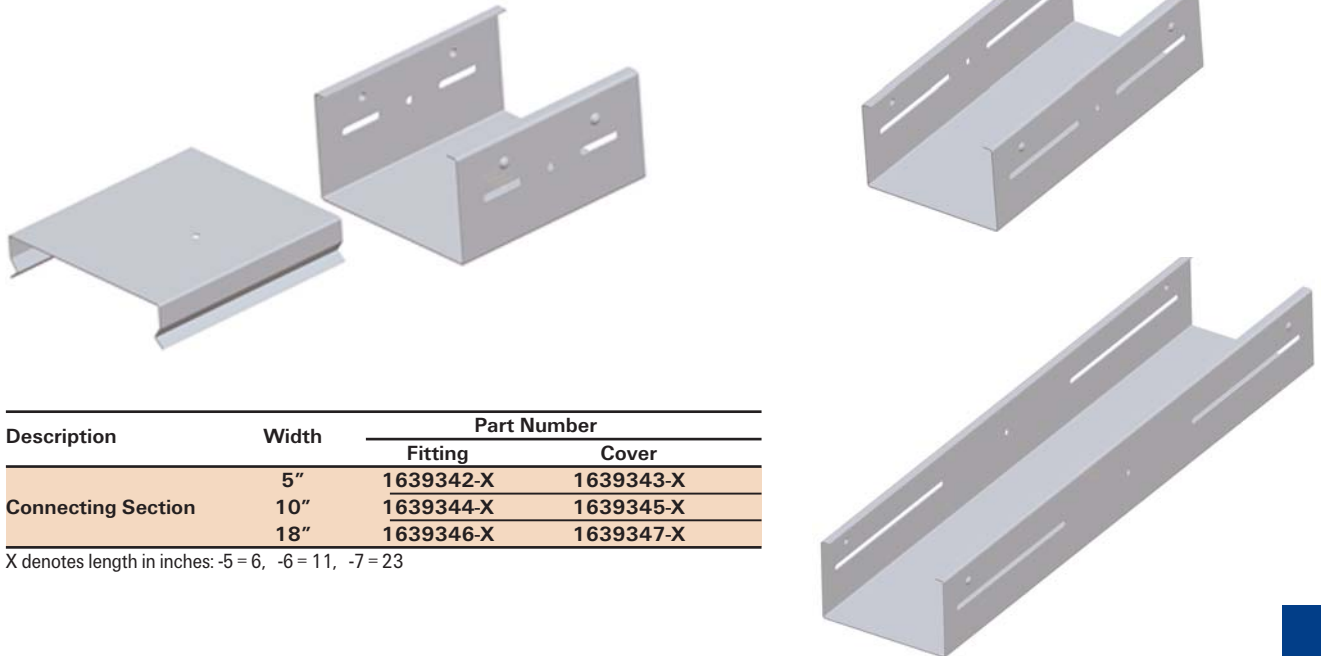

Description	Width	Part Number	
		Fitting	Cover
Connecting Section	5"	1639342-X	1639343-X
	10"	1639344-X	1639345-X
	18"	1639346-X	1639347-X

X denotes length in inches: -5 = 6, -6 = 11, -7 = 23

219

Cabletray Raceway System

**Horizontal Fittings
T, Cross, and L (90°, 45°, 15°) Sections
and Covers**



T Section

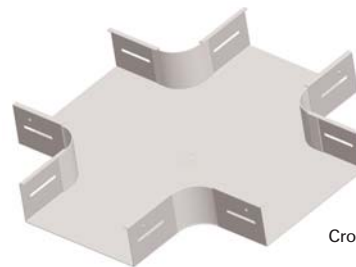

Cross Section



L Section

Description	Part Number	
	Fitting	Cover
T Section	1639348-X	1639349-X
Cross Section	1639350-X	1639351-X
L Section	90°	1639352-X
	45°	1639362-X
	15°	1639364-X
		1639353-X
		1639363-X
		1639365-X

X denotes width in inches: -1 = 5, -2 = 10, -3 = 18

5

Vertical Fittings

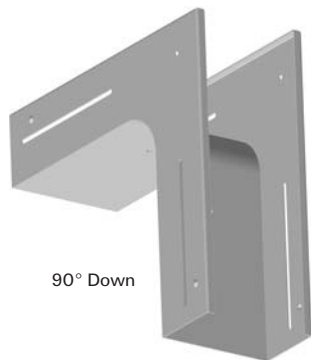

90° Down

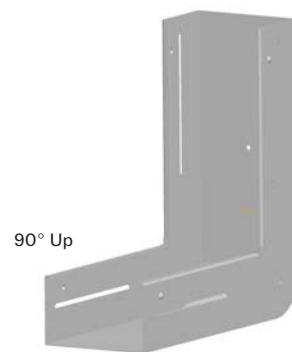

90° Up

Description	Part Number	
	Fitting	Cover
Vertical 90° Up	1639354-X	1639355-X
Vertical 45° Up	1639356-X	1639357-X
Vertical 90° Down	1639358-X	1639359-X
Vertical 45° Down	1639360-X	1639361-X

X denotes width in inches: -1 = 5, -2 = 10, -3 = 18

220

Cabletray Transitions

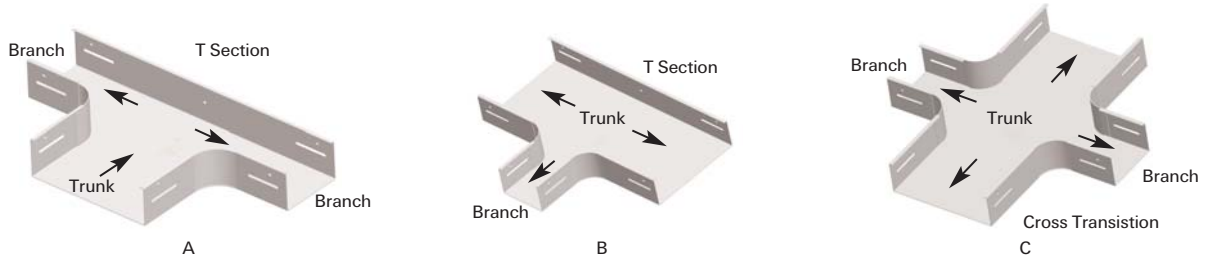

Description	From	To	Figure	Part Number	
				Fitting	Cover
T Section	10" Trunk	Two 5" Branches	A	1639348-4	1639349-4
	10" Trunk	One 5" Branch	B	1639348-5	1639349-5
	18" Trunk	Two 10" Branches	A	1639348-6	1639349-6
	18" Trunk	One 10" Branch	B	1639348-7	1639349-7
Cross Section	10" Trunk	Two 5" Branches	C	1639350-4	1639351-4
	18" Trunk	Two 10" Branches	C	1639350-5	1639351-5
Straight Section - Right	5"	10"	-	1639370-5	1639371-5
Straight Section - Left	5"	10"	-	1639372-5	1639373-5
	18"	10"	-	1639374-6	1639375-6

5

Cabletray Accessories

Description	Part Number
Cable Separator	1639376-X
Rack Drop, 5 inch width	1639377-1
Vertical Drop	1639378-X
Vertical Drop Cover 5"	1639343-6
Vertical Drop Cover 10"	1639345-6
Vertical Drop Cover 18"	1639347-6
Slack Tray, 5 inch width	1639367-1
Slack Tray Cover, 5 inch width	1639368-1
End Cap	1639366-X
End Cap Covers 5"	1639343-5
End Cap Covers 10"	1639345-5
End Cap Covers 18"	1639347-5

X denotes width in inches: -1 = 5, -2 = 10, -3 = 18

221

Cabletray Mounting System

Mounting Components

Description	Part Number
Spanner Bracket	1639379-W
Pedestal Bracket, 5 inch width	1639380-1
Universal Mounting Bracket Kit	1639381-X
Adjustable Floor Bracket	Y-1639382-Z

W denotes inches: -1 = 24, -2 = 34, -3 = 24 EQ, -4 = 34 EQ
EQ = meets seismic requirements

X denotes FiberTray width in inches: -1 = 5, -2 = 10, -3 = 18

Y denotes Range of height above floor in inches: blank = (2 to 3 1/2),
1- = (2 to 8 1/2), 2- = (6 to 15)

Z denotes inches: -1 = 5, -2 = 10, -3 = 18, -4 = 34

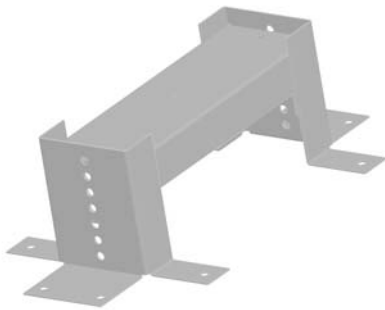

Adjustable Floor Bracket



Pedestal Bracket

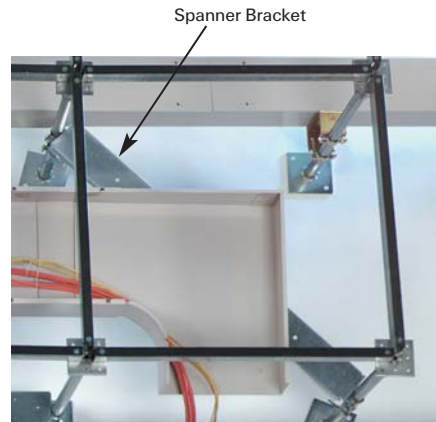

Spanner Bracket

Hardware Components

Description	Part Number	Package Qty.
Grounding Wires with Hardware	9-1201816-2	10
Fastening Hardware	7-1201816-0	100
Fastening Clips	4-1199891-8	100

Horizontal Finger Duct Panels



Product Facts

- Cable management accessories for EIA standard 19" equipment racks
- Suitable for high performance twisted pair and optical fiber distribution cables and patch cords
- Horizontal finger duct panels available in single- and double-sided versions

Description	Panel Height	Front (H x D)	Rear (H x D)	Figure	Part Number	
Single-Sided	Cable Management Panel	1U (1.75")	1.5" x 2"	-	-	1375161-X
		2U (3.50")	1.5" x 3"	-	-	1375162-X
	Front Replacement Covers	1U (1.75")	3.0" x 3"	-	A	1375163-X
		2U (3.50")	-	-	-	1479225-X
Double-Sided	Cable Management Panel	1U (1.75")	1.5" x 2"	1" x 4"	-	1375160-X
		2U (3.50")	1.5" x 3"	1" x 4"	-	1375159-X
	Front Replacement Covers	1U (1.75")	3.0" x 3"	2" x 4"	B	1375158-X
		2U (3.50")	-	-	-	1479225-X
	Rear Replacement Covers	1U (1.75")	-	-	-	1479222-X
		2U (3.50")	-	-	-	1479224-1
					1479223-1	

X denotes cover style: -1 = Standard, -2 = Extended

5

Vertical Finger Duct Panels

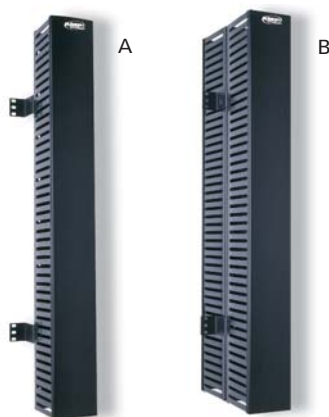

Product Facts

- Cable management accessories for EIA standard 19" equipment racks
- Suitable for high performance twisted pair and optical fiber distribution cables and patch cords
- Vertical finger duct panels available in single- and double-sided versions
- Center mount Vertical Finger Duct Panels mount between racks for added stability
- Replacement covers are packaged ten (10) per box

	Mounting Position	Panel Height	Front (W x D)	Rear (W x D)	Figure	Part Number
Single-Sided	Side Mount	35"	4" x 5"	-	A	1375165-1
		78"	4" x 5"	-	-	1375258-1
	Center Mount	35"	4" x 5"	-	B	1375167-1
		78"	4" x 5"	-	-	1375260-1
Double-Sided	Side Mount	35"	4" x 5"	4" x 5"	A	1375164-1
		78"	4" x 5"	4" x 5"	-	1375257-1
	Center Mount	35"	4" x 5"	4" x 5"	B	1375166-1
		78"	4" x 5"	4" x 5"	-	1375259-1
Replacement Covers	Front or Rear	35"	-	-	-	1479226-1
	Front	78"	-	-	-	1479227-1
	Rear	78"	-	-	-	1479227-2

223

Management Panels

Horizontal Ringed Cable Management Panels

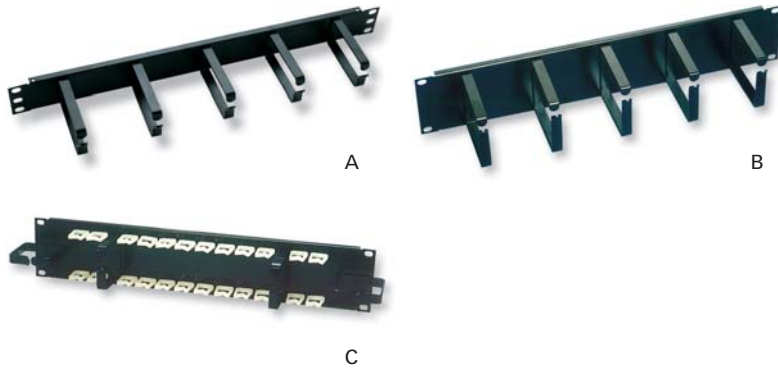

Description		Figure	Part Number
1U Panel	1.75"	A	558329-1
2U Panel	3.50"	B	558331-1
	3.50" with Cable Clips	C	569049-1

Product Facts

- Panels mount to the front of 19" racks and provide for the orderly dressing and routing of cable assemblies
- Threaded studs on the back of the panels allow the installation of an optional Cable Support Bar (see this chapter)
- 2U (3.50") 569049-1 comes with cable clips

5

Vertical Ringed Cable Management Panels

PART NUMBER 559371-1



Product Facts

- Lightweight durable 11 AWG aluminum
- Front and rear management designed into one piece
- Compact size for simple, quick installation
- Mounts to standard EIA hole pattern
- High capacity management rings for large patching applications
- One design accommodates both end-mount and inter-bay management needs
- Partial or full rack loading
- Requires rack with standard EIA hole pattern on both front and rear surfaces of channel uprights
- Dimensions – 24.40" H x 3.47" W
- Four Cable Management Rings, Dimensions – 3.50" W x 6.25" D

Rack Mount Cable Trough, Top

PART NUMBER 559370-1

- Features down-radiused cable exit to vertical cable management
- Dimensions (overall) – 4.20" H x 19.00" W x 3.75" D
- Mounts in 1U (1.75") of rack space

Product Facts

- Light weight durable 11 AWG aluminum
- Fit standard 19" racks
- Mounts to standard EIA hole pattern
- Provide cable management within the rack bay or multiple rack line-ups

Rack Mount Cable Trough, Bottom/Middle

PART NUMBER 559369-1

- Dimensions (overall) – 5.22" H x 19.00" W x 3.75" D
- Mounts in 3U (5.25") of rack space

224

Rack Mount Cable Management Rings, Vertical

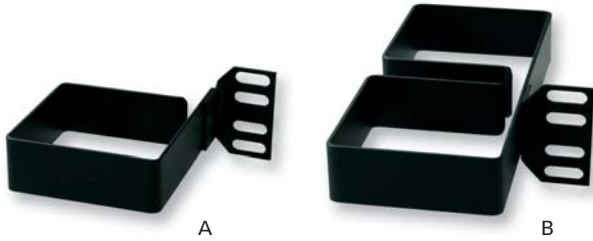

Product Facts

- Mount between adjacent panels
- Provide a vertical “trough” for patch cable management

Description	Figure	Part Number
Single Ring	A	558334-1
Double Ring (for front and rear management)	B	406498-1

Rack Mount Cable Management Rings

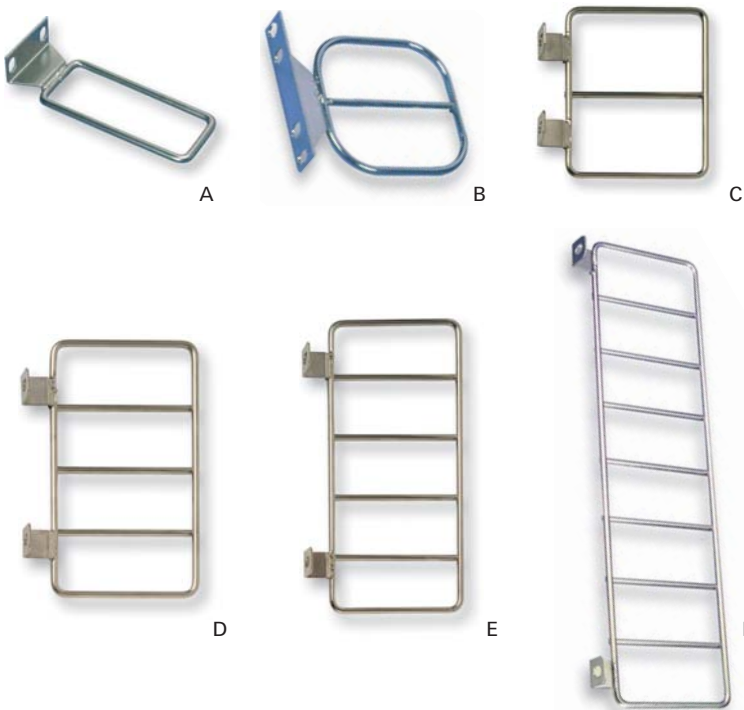

Product Facts

- Rings are installed directly on 19" racks with the same mounting screws used to secure the panels to the rack
- Provide a space-saving alternative to cable management panels
- Must be ordered to match the height of the panels to which they are attached

5

Description	Figure	Part Number
1U Ring	A	558312-1
2U Ring	B	558265-1
3U Ring	C	556560-1
4U Ring	D	556561-1*
5U Ring	E	556745-1
9U Ring	F	556562-1

*Note: Use two for a 14-inch panel.

225

Cable Support Bars

Cable Support Bars



Product Facts

- Designed to provide additional cable support and routing control in the rear of 19" racks and panels
- See support bar to patch panel compatibility chart
- Cable support bars that mount directly to rack provide the best support. Other bars are available for specialty application

Description	Figure	Compatible with Panel	Part Number
Mounts to back of rack, 5" deep	A	(mounts to rack)	557548-1
Mounts to back of rack, 2" deep	B	(mounts to rack)	406042-1
Mounts to rear of Cable Management Panels	-	558329, 558331, 569049	558301-1
Mounts to rear of 110Connect and SL Series Patch Panels	-	406330, 406331, 406332 1475194, 1479155, 147155, 406981 1479156, 1375014, 1375015, 1375016, 1479449, 1479450, 1479206, 1479208	1479860-1
Mounts to rear of XG and SL Multimedia Patch Panels, 1U	-	1933307, 1933309, 1933319, 1933321 1933331, 1933323	1933425-1

5

MRJ21 Cable Support Bars

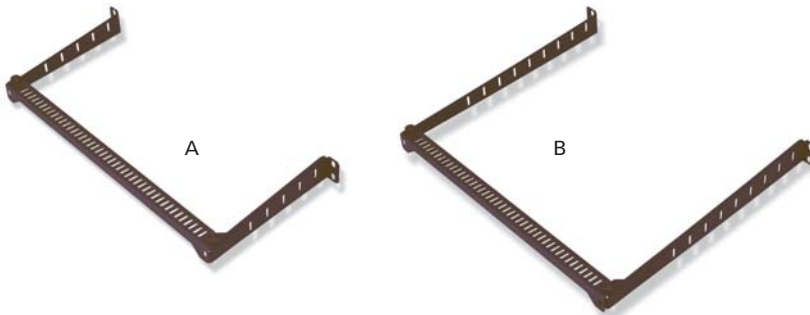

Product Facts

- Mounts to the back of 19" racks
- Designed to provide additional cable support and routing control behind 19" racks and panels
- MRJ21 slotted manager bar for easy tie down
- Horizontal and vertical mounting option for MRJ21 tie down bar

Description	Depth	Figure	Part Number
MRJ21 Cable Manager Bar	6"	-	1933352-1
	9"	A	1933352-2
	12"	-	1933352-3
	16"	B	1933352-4

VELCRO Cable Ties



Description	Part Number
1" x 8"	1375253-X
1" x 12"	1375254-X
5/8" x 5 yards	1375255-X
1" x 12" Flame Retardant*	1375256-2

X denotes color: -2 = Black, -3 = White, -4 = Gray, -5 = Orange, -6 = Blue, -7 = Red, -8 = Yellow, -9 = Green, 1-0 = Violet

*Note: Complies with NEC 300-22(c) and (d) for use in environmental air handling spaces. Available in Black only.



Product Facts

- For 8-inch and 12-inch ties, an order quantity of one equals one roll of ten ties

5

AMP-TY Nylon Cable Ties



Length in(mm)	Dimensions (Approximate)		Minimum Tensile Strength	Maximum Bundle Diameter in(mm)	Package Quantity	Color	Part Number
	Width in(mm)	Thickness in(mm)					
4 (103.0)	0.096 (2.44)	0.037 (0.94)	18 lbs 80.1 N	0.75 (19.10)	1000	Natural	2-604771-9
						Black	2-604771-0
					100	Natural	1-604771-9
						Black	1-604771-0
6 (155.0)	0.140 (3.56)	0.045 (1.14)	30 lbs 133.5 N	1.25 (31.75)	1000	Natural	2-603227-9
						Black	2-603227-0
					100	Natural	1-603227-9
						Black	1-603227-0
8 (204.0)	0.184 (4.67)	0.047 (1.19)	50 lbs 222.5 N	1.75 (44.45)	1000	Natural	2-604772-9
						Black	2-604772-0
					100	Natural	1-604772-9
						Black	1-604772-0
12 (300.0)	0.183 (4.65)	0.051 (1.30)	50 lbs 222.5 N	3.00 (76.20)	1000	Natural	2-604751-9
						Black	2-604751-0
					100	Natural	1-604751-9
						Black	1-604751-0

227

Notes

5

228

AMPTRAC CONNECTIVITY MANAGEMENT SYSTEM

Analyzers	232
Twisted Pair Patch Panels	233
MRJ21 Patch Panels	234
Patch Panel Retrofit Kits	234
Optical Fiber Patch Panels	235
LAN Electronic Sensor Strip	236
Twisted Pair Patch Cable Assemblies	237
Optical Fiber Patch Cable Assemblies	237
Analyzer I/O Cable Assemblies	238
I/O Cable Management Brackets	239
iTRACS® Infrastructure Manager™ Software	240-241

Chapter Summary

- Tyco Electronics features a comprehensive line of hardware and software to turn cabling systems and their connected devices into intelligent networks

6



AMPTRAC CONNECTIVITY MANAGEMENT SYSTEM

The requirements of today's rapidly growing and changing infrastructures are no longer satisfied by traditional IT infrastructure management but need intelligent, real-time management. An Intelligent Infrastructure Management System (IIMS) is critical to providing accurate cable and network management information into the IT Infrastructure Library (ITIL).

The AMPTRAC Connectivity Management System turns cabling systems and their connected devices into intelligent networks by reducing costly and time-consuming manual cable management. With this system, you can track and document all moves, adds and changes to your network from a centralized location as they occur. This fully automated system optimizes asset utilization, maintains accurate documentation and helps prevent costly errors.

The AMPTRAC Connectivity Management System's easy-to-implement hardware coupled with iTRACS IM cutting-edge software can be integrated into new or existing network. By allowing you to proactively respond to any changes in connectivity through customizable alerts or alarms, the iTRACS software optimizes your network monitoring and security. AMPTRAC hardware when used in conjunction with iTRACS software provides the missing link that integrates network management and physical layer management — revolutionizing the way networks are controlled and documented.

This one-of-a-kind infrastructure management system automatically generates a complete physical topology of your network at the Telecommunications Room/Data Center, while helping you manage and trouble shoot the network remotely.

System Benefits

- Reduces downtime and response time
- Integrates network and physical layer management
- Helps to increase productivity
- Reduces operating costs
- Improves port and asset utilization
- Provides accurate and timely information
- Improves service levels
- Provides alerts and alarms for all changes relating to devices and their connectivity
- Provides work order control module with auto-provisioning
- Over 60 detailed reports available
- Audit trail based on historical log file

System Features

- Simplified installation and design with stackable, configurable Analyzer
- Complete product line support
 - XG Cat 6A Shielded
 - Cat 6 Unshielded
 - Fiber (MT-RJ, SC, LC)
 - MPO (fiber) and MRJ 21 (copper)
- Analyzer LCD displays work order and circuit trace information
- Analyzer provides good and bad audible tone alerts
- Support for non-English languages

AMPTRAC Hardware Overview

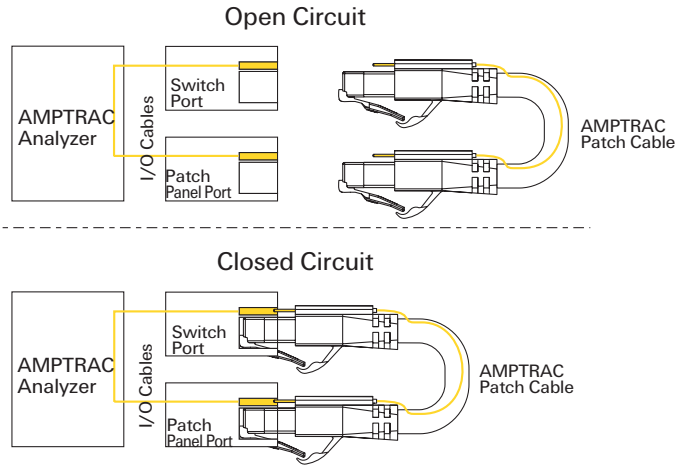

AMPTRAC Basic Operating Principle

- 9th wire technology in patch cord establishes open and closed circuit which can be monitored
- Analyzer monitors open/closed circuit and tracks connectivity
- Analyzer sends data to iTRACS IM software database
- iTRACS IM software sends Work Order and circuit info to AMPTRAC Analyzer

AMPTRAC System and Components

- **AMPTRAC Analyzer:** The Device that tracks the connections between sensor contacts and communicates with iTRACS IM software database
- **AMPTRAC I/O cables:** Connects sensor contacts (patch panel and electronics) to analyzer
- **AMPTRAC Patch Panels:** Patch panels with integrated sensor contacts
- **AMPTRAC Sensor Strips:** Sensor contacts that are applied to network electronics port fields
- **AMPTRAC Patch Cords:** Interconnects between patch panel and switch ports which have an integrated '9th' wire that is used to make connection between sensor contacts
- **IM Software:** The software that manages the Analyzers, and correlates the connectivity information from the analyzers to a database model of the customer infrastructure
- **AMPTRAC Server:** A higher level PC (often Rack mounted) that runs the iTRACS IM software

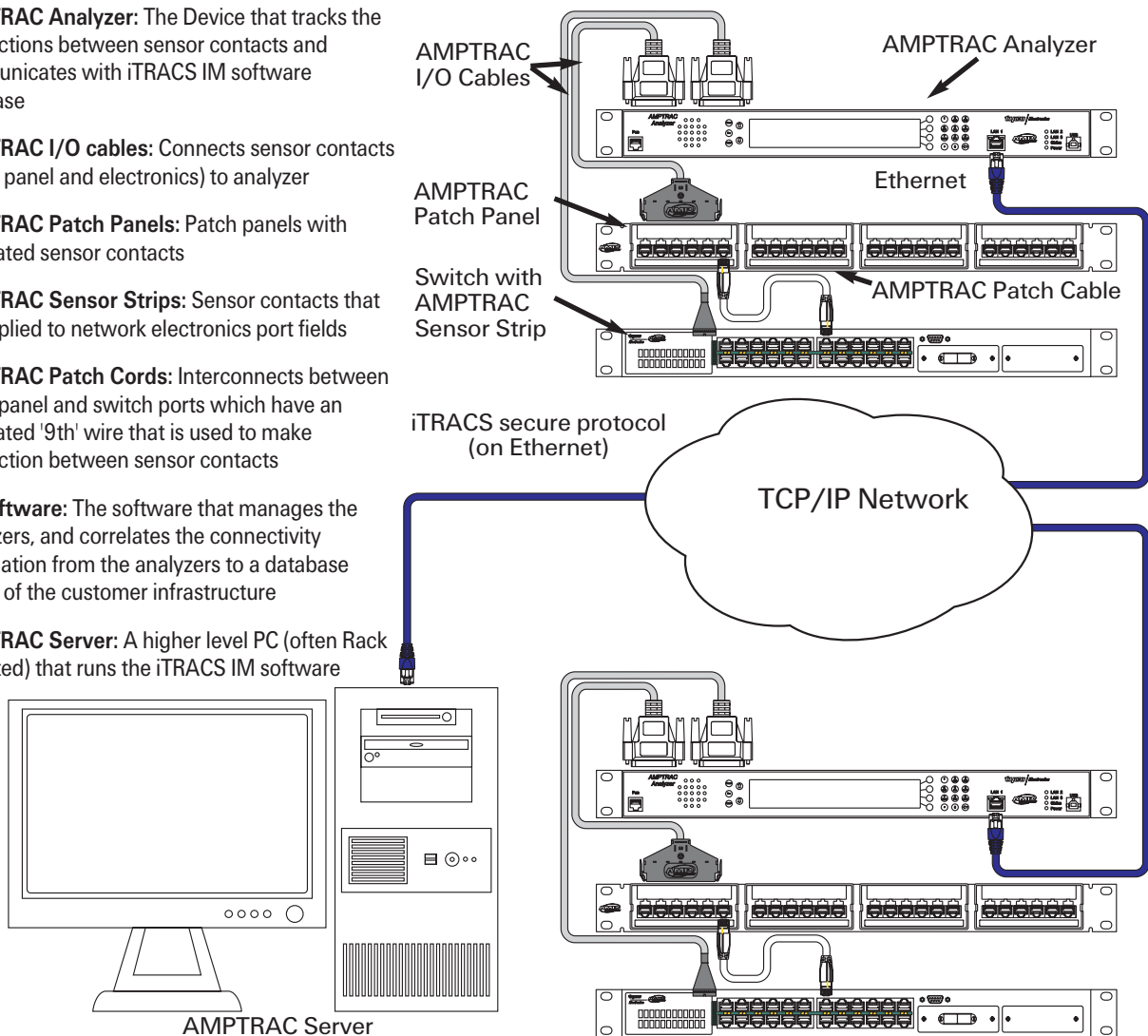

Analizers



6

The AMPTRAC Connectivity Management System Analyzer discovers connects/disconnects and communicates the port ID information in real-time to the AMPTRAC database software over a TCP-IP connection. When a patch cord is inserted or removed from a port, the AMPTRAC sensory circuit immediately notifies the database software to update and document the change in connectivity. This provides network administrators responsible for small to enterprise wide multi-site networks, with vital time saving up to-the minute information about the status of their network from the hardware layer up. Any change in connectivity can be checked and authorization verified, and if appropriate, action taken if the action is unauthorized.

Description	Ports Monitored	Part Number
Analyzer, US Power Cord with IM Software and 1 Year Service Level Agreement	336	3-1591306-1
	168	4-1591306-1
Extended 3-Year Analyzer Warranty		9-1591306-0

Note: A complete channel connection to a work area outlet passes through two monitored ports, the network switch and the patch panel. Therefore, each active channel monitored requires two Analyzer ports.

Product Facts

- Universal analyzer design
 - Analyzer can be configured as a master or slave
 - Any unit can directly communicate to database server or through another analyzer
 - Virtually unlimited in number of ports/drops which can be monitored
- Highly flexible design and implementation allowing for use in office buildings, data centers and remote/branch offices
- Analyzer sold with license to iTRACS IM software (see pages 244-245 for description of software)
- Available in 336-port and 168-port versions
 - Both 1U – rack space
- Positive, keyed and reliable DB25 connection for I/O cables
- Shallow depth at 6.25" (160 mm)
- Suitable for shelf or 19" rack or cabinet mounting
- Large 4 line LCD display providing interactive communications with the database
- Supports connection of PDA, electronic tablet or computer to analyzer via Ethernet port
- Three 10/100BASE-Tx Ethernet ports provided (1 in front, 2 in rear) to provide connection to LAN and server as well as allow analyzer to communicate via another analyzer
- Use of latest and current circuitry design
- Little heat generation – no concerns over heat management in rack or cabinet

Enhancements

- AMPTRAC Analyzer provides Work Order information on the LCD screen
- Provides a "good or bad" tone from Analyzer based on Work Order information
- Version available to support character based language

Twisted Pair Patch Panels

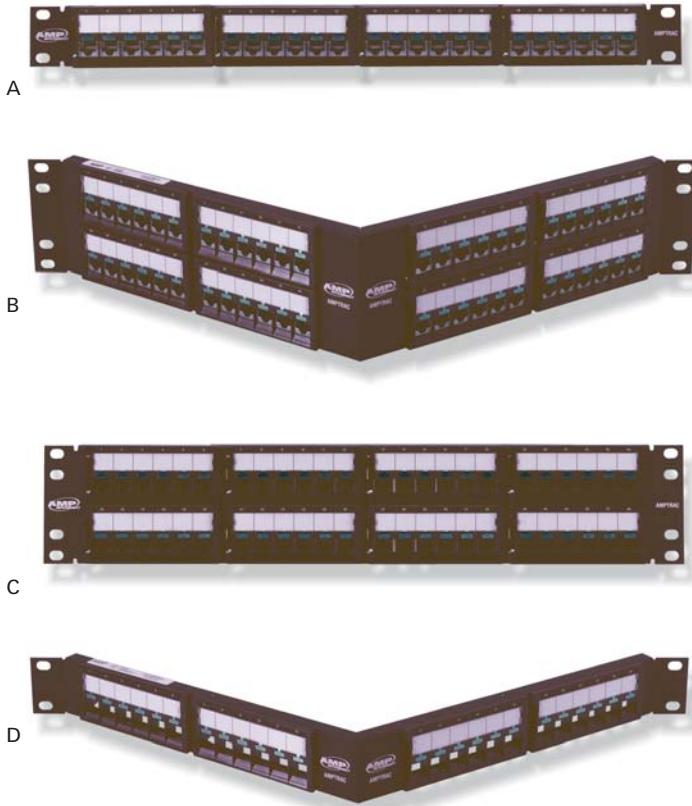

Product Facts

- Incorporates integrated solid contacts for enhanced protection, appearance and reliability
- I/O cable connection made via 110 IDC punch down in the rear of patch panel, minimizing pre-planning and allowing for cables to be cut to length (1435844-X) or with 110 plug and play cable assembly (1933152-Y) (see page 238)
- Cost-effective solution for AMPTRAC Connectivity Management System ready solution - install AMPTRAC patch panels now and analyzer, I/O Cables, and software later
- Available in straight versions as well as angled versions for improved cable and space management
- Uses AMP NETCONNECT high-performance AMP-TWIST shielded 6A and SL Series Cat 6 UTP Modular Jacks
- XG Category 6A shielded supports 10 Gigabit transmission
- XG Category 6A and 6 Patch Panels come unloaded with Modular Jacks bagged separately for field termination with SL Series Modular Jack Termination Tool P/N: 172150 (see Chapter 1.7)
- SL Series Multimedia Patch Panels come unloaded and accept SL Series Jacks for custom configurations

6

Description	Type		Height Rack Units (inches)	Figure	Part Number
XG Cat 6A (Shielded)	Straight	24-Port	1U (1.75")	A	1933331-1
		48-Port	2U (3.50")	-	1933332-1
	Angled	24-Port	1U (1.75")	-	1933333-1
		48-Port	2U (3.50")	B	1933334-1
Category 6 (Unshielded)	Straight	24-Port	1U (1.75")	-	1933327-1
		48-Port	2U (3.50")	C	1933328-1
	Angled	24-Port	1U (1.75")	-	1933329-1
		48-Port	2U (3.50")	-	1933330-1
SL Series Multimedia* (without jacks)	Straight	24-Port	1U (1.75")	-	1933323-1
		48-Port	2U (3.50")	-	1933324-1
	Angled	24-Port	1U (1.75")	D	1933325-1
		48-Port	2U (3.50")	-	1933326-1

Note: Previous versions of AMPTRAC SL Patch Panels require I/O cable 1499656-X instead of New version 1933152-X.
 *SL Series multimedia panels do not accept dust-covered jacks

Cable Management Bar



Description			Figure	Part Number
Rear Cable Management Bar	For mounting to Rack	1 per 24-Port	A	557548-1
Cable Management Bar	For mounting to Patch Panel	24-Port	B	1933425-1

233

Patch Panels and Retrofit Kits

MRJ21 Patch Panels



Product Facts

- High-performance copper cabling solution
- High-density, small form factor connectivity
- Factory terminated and tested
- Modular, pluggable design
- 4-Pair MRJ21 Patch Panels support applications which use four or fewer pairs including 10BASE-T, 100BASE-T and 1000BASE-T
- 2-Pair MRJ21 Patch Panels support applications which use two or fewer pairs including 10BASE-T, and 100BASE-T
- Utilizes HD22 interface for AMPTRAC I/O cable (1499507-X) (see page 238)

Description	Applications	Figure	MRJ21 Connectors	Part Number	
Straight Patch Panel	24-Port	4-Pair (10/100/1000BASE-T)	–	4	1777029-2
	48-Port	2-Pair (10/100BASE-T)	–	4	1777042-1
		4-Pair (10/100/1000BASE-T)	A	8	1777041-1
Angled Patch Panel	48-Port	4-Pair (10/100/1000BASE-T)	B	8	1777053-1

6

Patch Panel Retrofit Kits



Product Facts

- Kits are designed to retrofit the AMPTRAC Connectivity Management System to existing installations of AMP NETCONNECT SL Series standard unshielded, 110Connect patch panels, or angled and standard MRJ21 patch panels
- SL Series and 110Connect kits contain material to retrofit 24 ports; two kits are required for a 48-port patch panel
- MRJ21 kits contain materials to retrofit 24- or 48-port patch panels as listed

For Use With	Fitted Ports	I/O Interface	Figure	Part Number
110Connect (Cat 5 or 5e) Straight Patch Panels	24	2.0 mm AMPMODU	–	1499639-1
SL Series (Cat 5e or 6) Straight Patch Panels	24	2.0 mm AMPMODU	A	1499640-1
MRJ21 Angled Patch Panels	48	HD22	B	1479853-1
MRJ21 Straight Patch Panels	48	HD22	–	1479951-1
	24	HD22	–	1479894-1

234

AMPTRAC Optical Fiber Enclosures

Optical Fiber Patch Panels and Accessories



Product Facts

- Available for MT-RJ, LC Duplex and SC Duplex systems
- Available in 62.5 μm, XG (850 nm LO 50 μm) Multimode and Single-mode
- Support for field termination with interface module or preterminated use with MPO cassettes
- AMPTRAC MT-RJ and LC Duplex systems use modified fiber enclosures listed below. MT-RJ and Duplex LC AMPTRAC Interface Modules are sold separately (see below)
- AMPTRAC Duplex SC Adapter Plates and MPO Cassettes (Figures F and G) use standard AMP NETCONNECT Enclosures in Chapters 2.5 and 2.6

MT-RJ and Duplex LC

Description	I/O Interface	Type	Capacity	Fiber Type	Rack Units	Figure	Part Number
AMPTRAC MT-RJ and Duplex LC Patch Panels		Drawer	4 Interface Modules or MPO Cassettes 24-Port (48-Fiber) Modules and Cassettes sold separately	–	1U	A	1933443-1
		Enclosure	12 Interface Modules or MPO Cassettes 72-port (144-Fiber) Modules and Cassettes sold separately	–	4U	B	1435593-2
AMPTRAC MT-RJ Interface Module	IDC or 110 Plug & Play (1435844/1933152)	Interface Module with SL Insert	6-ports (12-Fiber) SL Insert included (MT-RJ Jacks sold separately)	62.5 μm (OM1) XG 50 μm (OM3) Single-mode (OS1)	–	C	1933421-1 1933421-2 1933421-3
AMPTRAC Duplex LC Interface Module	IDC or 110 Plug & Play (1435844/1933152)	Interface Module with LC Adapters	6-ports (12-Fiber) SL Insert and LC Adapters Included	62.5 μm (OM1) XG 50 μm (OM3) Single-mode (OS1)	–	D	1933420-1 1933420-2 1933420-3
AMPTRAC MT-RJ MPO Cassettes	6-Position Mod Plug (RJ-11) (1499684)	MPO Cassette	6-ports (12-Fiber)	62.5 μm (OM1) XG 50 μm (OM3) Single-mode (OS1)	–	E	1435594-2 1435672-2 1435673-2
AMPTRAC Duplex LC MPO Cassettes	6-Position Mod Plug (RJ-11) (1499684)	MPO Cassette	6-ports (12-Fiber)	62.5 μm (OM1) XG 50 μm (OM3) Single-mode (OS1)	–	E	1499647-2 1499648-2 1499649-2

Note: AMPTRAC MT-RJ and Duplex LC require use of above Drawer or Enclosure.
AMPTRAC MT-RJ Interface Module requires purchase of appropriate MT-RJ Jack or pigtail.

AMPTRAC Duplex SC

AMPTRAC Duplex SC Snap-in Adapter Plates	6-Position 2.54 MTE (1499685)	Snap-in Adapter Plate Retrofit Kit	6-ports (12-Fiber) includes adapter For Adapter Plate 559596	Multimode Single-mode (OS1)	–	F	1435657-1 1435657-2 1435685-1
AMPTRAC Duplex SC MPO Cassettes	6-Position 2.54 MTE (1499685)	MPO Cassette	6-ports (12-Fiber)	62.5 μm (OM1) XG 50 μm (OM3) Single-mode (OS1)	–	G	1435653-2 1435688-2 1435689-2

Note: AMPTRAC Duplex SC Snap-in Adapter Plate and MPO Cassettes use standard fiber enclosures in Chapters 2.5 and 2.6.

Sensor Strips

LAN Electronic Sensor Strip



Product Facts

- Sensor Strips are readily available for a number of LAN electronic equipment types
- All Sensor Strips are Printed Circuit Board (PCB) with 2.0 mm AMPMODU connector.
- Custom Sensor Strips can be designed to work with most LAN electronic equipment. For assistance, call AMP NETCONNECT Customer Service at 1-800-553-0938
- LAN equipment manufacturer, model number, and model revision are required in determining the selection of the proper sensor strip
- Sensor strips contain an adhesive backing for easy installation

RJ-45 Copper Ports

Description of Equipment	Part Number	# of Ports	# Ports per Group	# of Port Groups
AMP NETCONNECT 50 Port Telephone Patch Panel	1435954-1	50	50	1
CISCO 4000 and 6000 Blades (48-port)	1933228-1	48	16	3
NORTEL BAYSTACK 470-48T	1435939-1	48	16	3
CISCO WS-3750G-48TS-S	1499798-1	48	16	3
CISCO 4000 and 6000 RJ-45 48-Port switch blades	1499651-1	48	12	4
NORTEL BAYSTACK 5520	1499660-1	48	12	4
CISCO 2950, WS-C2950SX-24	1435827-1	26	8/2	3/1
CISCO 4000 and 6000 RJ-45 48-Port switch blades	1435346-1	24	12	2
CISCO 3500 (48-Port) and WS-C2950G-48-EI	1435346-4	24	16/8	2
CISCO 3500 - 24-Port	1435346-5	24	12	2
NORTEL BAYSTACK 450-24T	1435933-1	24	12	2
CISCO 3950G-24PS, Alcatel 6600-24	1777005-1	24	12	2
NORTEL PASSPORT 8648	1777014-1	24	12	2
Tyco Electronics Stackable 1591099-X	1933184-1	24	8	3
Enterasys	1499759-1	16	8	2
Extreme Summit48i 1433	1435927-1	16	8	2
CISCO 3750G-24TS-E, 3560-48TS, C2950G-24EI, 12-Port Generic	1777019-1	12	12	1
CISCO WS-3750G-24S	1499800-1	12	12	1
Extreme Summit1i, Summit5i, Alpine 3808	1435952-1	12	12	1
HP Procurve J4111A	1933098-1	8	8	1
MARCONI ES-3824	1499810-1	8	8	1

Fiber Ports

CISCO WS-X6324-100-FX-MM (24-Port MT-RJ)	1435937-1	24	24	1
MARCONI ESR5000 (24-Port MT-RJ)	1499875-1	24	4	6
CISCO 16-Port GBIC Blade "Ladder"	1435820-1	16	8	2
CISCO WS-3750G-12S-S (12-Port LC)	1499795-1	12	4	3
8-Port Fiber	1435849-1	8	8	1
MARCONI ESR5000 (8-Port SC uplink)	1499883-1	8	8	1
CISCO WS-3750G-24S (4-Port LC uplink)	1499794-1	4	4	1
MARCONI NM/4155MMSCE (4-Port SC uplink)	1499862-1	4	4	1
CISCO 3500 Fiber Uplink Ports "U" shape	1435818-1	2	2	1
2-Port LC Uplink	1479889-1	2	2	1
CISCO WS-3750G-48TS-S (2-Port LC uplink)	1499799-1	2	2	1
CISCO 2950 (2-Port Fiber uplink)	1933180-1	2	2	1
Single Fiber Uplink	1435950-1	1	1	1

Twisted Pair Patch Cable Assemblies

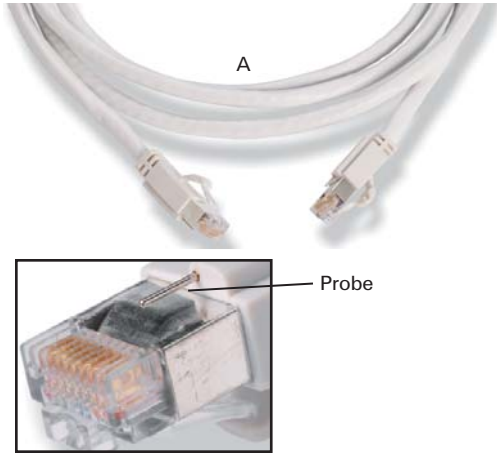

Product Facts

- Meets or exceeds Category 6 or 6A performance specifications
- Patch cable assemblies contain 9th conductor that is connected to external probe molded into the modular plug boot
- Backward compatibility permits assemblies to support new or existing Category 5e systems
- External probe makes contact with sensor pad on the sensor strip and/or patch panel sensor contact
- Off-center probe designed to accommodate stacked-jack LAN switch configurations
- Non-plenum jacketing, CMR rated
- Color matched over-molded snagless boots
- Crossover patch cable assemblies are unshielded with red cable jacketing and black over-molded boots

Description	Wiring	Figure	Part Number								
			Black	Gray	Blue	Green	Red	White	Yellow	Orange	Violet
Cat 6 Unshielded	Universal	A	1435864-X	1435835-X	1435861-X	1435860-X	1435862-X	1435834-X	1435863-X	1435918-X	1435919-X
Cat 6A Shielded	Crossover	-	-	-	-	-	1435953-X	-	-	-	-
	Universal	-	-	-	-	-	-	1499740-X	-	-	-

X denotes length in feet: -3 = 3, -5 = 5, -7 = 7, 1-0 = 10, 1-4 = 14, 1-6 = 16, 2--5 = 25

Optical Fiber Patch Cable Assemblies



MT-RJ

Product Facts

- Exceeds optical performance specifications for 62.5 μm (OM1), XG (50 μm (OM3)) multimode and single-mode (OS1)
- Duplex SC, MT-RJ and Duplex LC assemblies available
- Patch cable assemblies contain copper conductor that is connected to external probe
- External probe makes contact with sensor pad on the sensor strip and/or patch panel sensor contact
- One wire/one probe design to monitor duplex fiber port as a single connection
- OFCR riser rated and listed cable
- Cable is a mini-tri-zip design for flexibility and small size

Connector End 1 (Figure)	Connector End 2 (Figure)	Fiber Type	Part Number
MT-RJ	MT-RJ	62.5 μm (OM1)	1435351-X
		XG 50 μm (OM3)	1435352-X
		Single-mode (OS1)	1435353-X
MT-RJ	Duplex SC	62.5 μm (OM1)	1435355-X
		XG 50 μm (OM3)	1435356-X
		Single-mode (OS1)	1435357-X
MT-RJ	Duplex LC	62.5 μm (OM1)	1435792-X
		XG 50 μm (OM3)	1435793-X
		Single-mode (OS1)	1435794-X
Duplex SC	Duplex SC	62.5 μm (OM1)	1435724-X
		XG 50 μm (OM3)	1435725-X
		Single-mode (OS1)	1435726-X
Duplex SC	Duplex LC	62.5 μm (OM1)	1435795-X
		XG 50 μm (OM3)	1435796-X
		Single-mode (OS1)	1435797-X
Duplex LC	Duplex LC	62.5 μm (OM1)	1435789-X
		XG 50 μm (OM3)	1435790-X
		Single-mode (OS1)	1435791-X

X denotes length in meters: -1 = 1, -2 = 2, -3 = 3, -5 = 5, -7 = 7, 1-0 = 10

Duplex SC

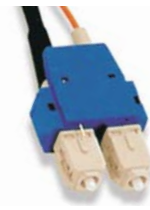

Duplex LC



Analyzer I/O Cable Assemblies

Analyzer I/O Cable Assemblies

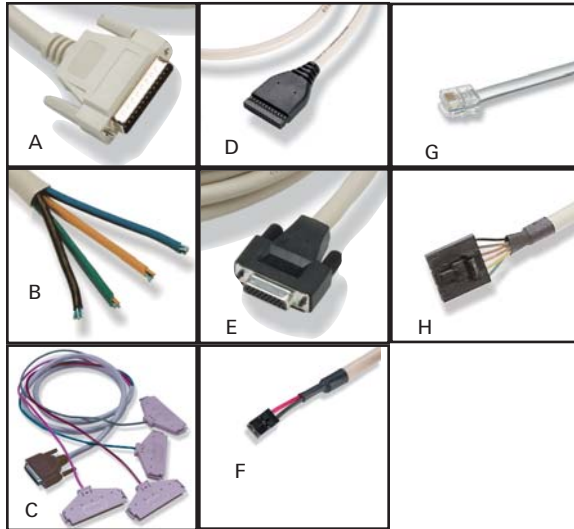

Product Facts

- AMPTRAC Connectivity Management System I/O Cable Assemblies are available with the following connectors
 - DB25 connector (on Analyzer)
 - 110 Plug and Play connector (on AMPTRAC SL Series patch panels) and MT-RJ/Duplex LC Interface Modules
 - HD22 connector (on MRJ21 connectors and shielded patch panels)
 - 2.0 mm AMPMODU connector (used with the Analyzer DB25 adapter 1499641-1)
 - 2.0 mm AMPMODU (on sensor strips)
 - 6-position modular plug (RJ11) (on MT-RJ and LC Duplex MPO Cassettes)
 - 6-position 2.54 MTE connector (on Duplex SC adapter plates and MPO cassettes)
- All I/O cables come with molded boots on the analyzer connector end
- I/O Cable Assemblies are Non-Plenum (CM rated) and Listed

Monitored Device	Application	Connector End 1 (Figure)	Connector End 2 (Figure)	Number of Conductors	Part Number
SL, MT-RJ, and LC Patch Panels	Cat 6A F/UTP, Cat 6 U/UTP MT-RJ, Duplex LC	DB25 - Analyzer (A)	None - used with IDC (B) 110 Plug & Play (C)	24 24	1435844-X 1933152-Y
MRJ21	MRJ21	DB25 - Analyzer (A)	HD22 (E) 2.0 mm (D)	24 24	1499507-Y 1435845-Y
PCB Sensor	LAN Switches	2.0 mm (D)*	2.0 mm (D)	16	1499686-Y
				12	1499687-Y
				8	1499688-Y
				6	1499689-Y
				2	1499690-Y
MT-RJ/LC MPO Cassettes	MT-RJ & Duplex LC	2.0 mm (D)*	6-Position, RJ11 (G)	6	1499684-Y
Duplex SC	Duplex SC Adapter Plates and MPO Cassettes	2.0 mm (D)*	6-Position 2.54 MTE (H)	6	1499685-Y

X denotes length in feet: -7 = 7, 1-4 = 14, 5-0 = 50, 9-9 = 100 (Note: Can be cut to length)

Y denotes length in feet: -4 = 4, -7 = 7, 1-0 = 10, 1-4 = 14, 2-5 = 25, 5-0 = 50, 7-5 = 75, 9-9 = 100

*NOTE: Use with DB25 Adapter P/N: 1499641-1 to connect monitored device to AMPTRAC Analyzer.

Adapter, DB25 to 2.0 mm AMPMODU

PART NUMBER 1499641-1



Back Detail - 24 Position
2.0 mm AMPMODU

Product Facts

- For use with 2.0 mm connectors less than 24 position
- Allows for side-by-side connections of multiple 2.0 mm AMPMODU connectors
- Allows for use of all analyzer ports
- Built-in strain relief and cable management

110 Plug and Play Kit

PART NUMBER 1933151-1



Product Facts

- Used with I/O Cable Assembly part number 1435844 (use 4 per assembly) for custom length
- Easy to lace and field terminate (no special tools required)
- Built-in latches and orientation features

I/O Cable Management Brackets

I/O Cable Management Brackets

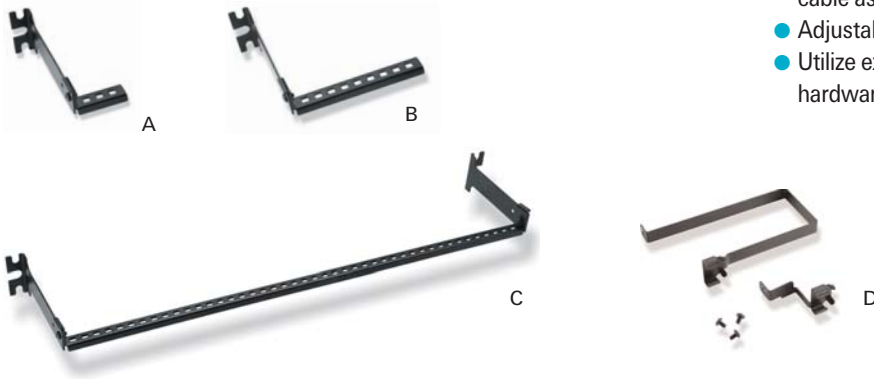

Product Facts

- Universal brackets provide support for I/O cable assemblies
- Adjustable
- Utilize existing patch panel mounting hardware

Description	Width	Figure	Part Number
Universal Bracket	40 mm	A	1499659-1
	100 mm	B	1499659-2
	448 mm	C	1499659-3
I/O Cable Retainer Bracket for Cisco 3500, 48-Port switch		D	1435779-1

iTRACS® Infrastructure Manager™ Software

Software for the AMPTRAC Connectivity Management System

THE PRODUCT DESIGN

iTRACS Infrastructure Manager software has been designed for customers of AMP NETCONNECT, as it functions in tandem with AMPTRAC hardware. The software is designed to explore and discover and map the connectivity of the customer network. It is further designed to simplify the process of all future moves, adds and changes (MACs) of end-users. The software allows simultaneous access by a spectrum of department representatives; these include help desk, planning, network administration, supervision and technicians.

THE CLIENT CUSTOMERS - THE PROBLEMS OF COMPLEX NETWORKS - SOLVED

iTRACS IM software is ideally suited to customers with complex data/telecom networks and critical applications. Examples include financial institutions, insurance providers, data centers, high security government facilities, military defense facilities, airports, medical centers, universities and corporate headquarters.

These customers and clients share the difficult management of complicated networks, requiring accurate record-keeping, high security, and frequent MACs. The simplification of the work order process also provides valuable benefits to client networks of any size, from small to enterprise network.

PRODUCT LEADERSHIP

iTRACS IM Software, as one of the earliest developers of Cable Management Software (CMS), has maintained an international leadership position in CMS design for more than 15 years. iTRACS IM has been specifically designed to automate the MAC record maintenance process, to simplify the user interface and to share access across departments.

Ask for a demonstration today!

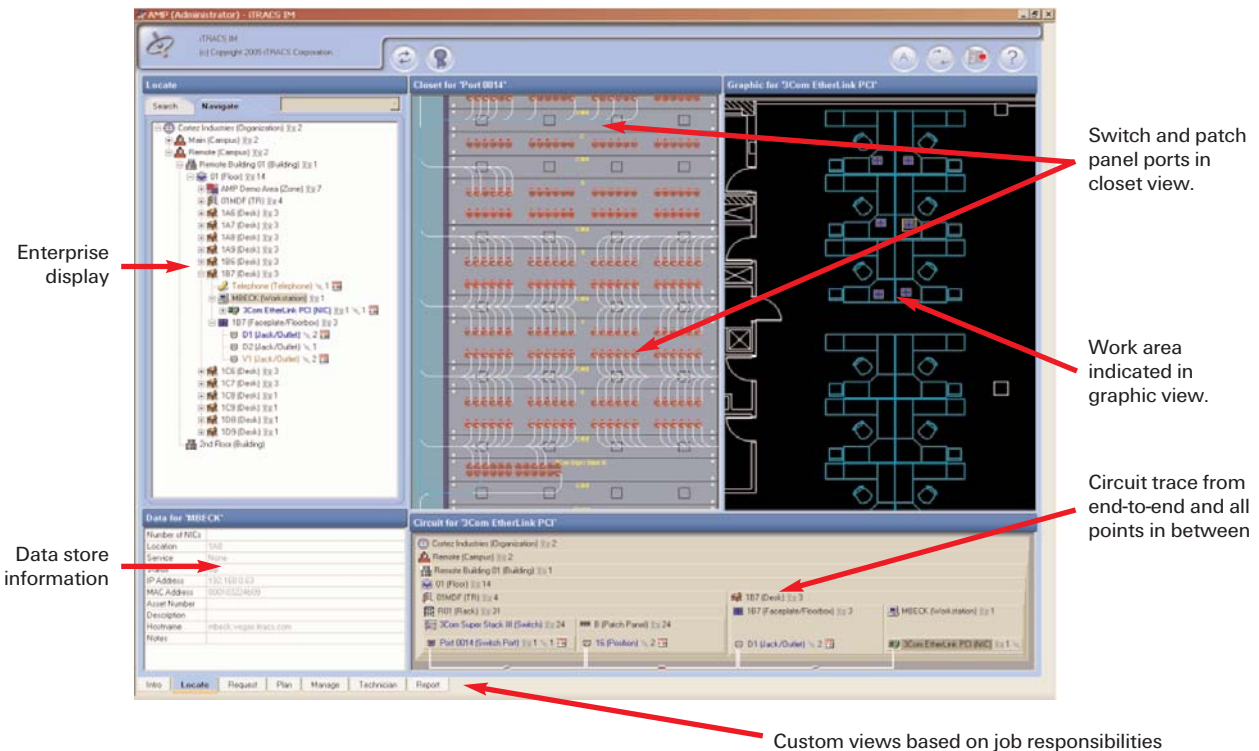

iTRACS® IM - Intelligent Infrastructure Management Software

iTRACS IM software has been designed to work with AMP NETCONNECT AMPTRAC Connectivity Management System hardware. Together they create an automated, accurate, real-time physical layer management system. This combined system proactively responds to changes in connectivity and intelligently records your cabling system and its devices with accurate documentation. You reduce costs by eliminating time-consuming manual work order processes. You also maximize your existing network investment by identifying under-utilized assets.

Product Facts

- Real-Time Monitoring - automates the process of discovering, documenting, monitoring, and managing the physical network's connections and its devices.
- Automatically Updates the Database - reports authorized or unauthorized changes in real time.
- Self-Discover Patching - discovers all iTRACS-enabled port connectivity.
- Event Logs - whenever the system detects a connectivity change, it automatically creates an entry in an internal comprehensive log.
- Automated Work Order Process - iTRACS Infrastructure Manager software provides a greatly automated work order system, to be shared by the Help Desk, Network/Telecom managers and technicians. It is the simplest and most intelligent system available. Each user works from a simple user interface, unique to their task.
- Access rights and privileges are determined by the administrator. Authorized users select proposed moves of workstations, phones, printers or other equipment. Moves can be performed singly or in bulk, as in departmental relocation. The system automatically generates auto-routing, and a step-by-step work order and schedule, which can be accepted or revised by the user. Tasks can be divided and distributed between various supervisors and technicians via email. Work orders can include system diagrams and floor plans.
- When a work order is completed for an iTRACS IM Software monitored port, the system record instantly updates, ensuring accurate information. Should an unauthorized change occur, iTRACS IM Software can generate a work order to reverse the unwanted action.
- For un-monitored ports, a simple verification by technical staff/management ensures that the work flow automatically updates the iTRACS IM Software database.
- The system can also generate comprehensive reports containing all work order details such as the author, status, creation and scheduled dates, and notes.
- Terminal Service - iTRACS IM Software can be accessed via terminal service therefore allowing full functionality and viewing by remote users.
- Tablet PC - with iTRACS IM Software Compatible hardware, you can use any Windows Tablet PC to setup AMPTRAC equipment; or to query the database in real time. You can also map ports, remotely create and delete database items, conduct circuit traces of individual ports, and perform diagnostic tests on specific ports. All other iTRACS IM Software functions are also accessible.
- Automatic Re-Synchronization - if a network outage should occur, the iTRACS IM Software database automatically re-synchronizes upon the restoration of power, showing network asset connectivity changes.
- Security Features - iTRACS IM Software distinguishes unauthorized changes from authorized ones.
- Alerts - receive a text message via email containing a pre-defined message.
- More Detailed Reports - iTRACS IM Software provides a library of detailed reports of cable, port and asset utilization. These reports are invaluable to network administrators and asset managers.
- Auto-routing - The system automatically generates suggested Auto-routing, and a step-by-step work order and schedule, which can be accepted or revised by the user.

IM Enhancements (9.0)

- Supports Character based languages as well as Latin based
- Work Order communicates with AMPTRAC Analyzer LCD

Description	Part Number
iTRACS IM Software with one-year Gold Plus Service Agreement	Sold With Analyzer
iTRACS IM Software Concurrent User Pack (5 additional users)	1479979-1



Notes

6

242

LAN ELECTRONICS AND WIRELESS

Compact Ethernet Switches	244-245
Smart Ethernet Switches	246-247
SNMP Managed Ethernet Switches	248
Ethernet Media Converters	249-250
Power over Ethernet (PoE) Products	251

Chapter Summary

- Wide range of high performance, cost-effective switches and media converters
- Unmanaged switches are ideal for small office, small workgroup or home office applications
- Smart switches are ideal for network managers who want to have a basic level of control of their network
- SNMP managed switches are full-featured Layer 2 switches perfect for the first point of network contact in enterprise applications
- Ethernet media converters products enable a wide range of reliable network solutions
- IEEE 802.3af compliant Mid-Span Power-Over-Ethernet (PoE) unit supports power and data over existing copper cabling

7



Compact Ethernet Switches

AMP NETCONNECT Ethernet LAN Switches

Tyco Electronics offers a wide range of high performance, cost-effective AMP NETCONNECT Ethernet Switches. The AMP NETCONNECT Switches include unmanaged Compact Ethernet Switches, Smart Ethernet Switches with built-in or optional fiber uplink ports and SNMP Managed Ethernet Switches with optional fiber or twisted pair Gigabit uplink ports.

AMP NETCONNECT basic, unmanaged Compact Ethernet Switches are ideal for Small Office/Home Office (SOHO), small workgroup or home networking applications. Smart Ethernet Switches have fiber uplink ports either built-in/fixed (8-Port switch only) or optional (16- and 24-Port switches) to enable high speed connections to backbones, servers, and network devices over single-mode or multimode (50 or 62.5/125 μm) fiber using industry standard MT-RJ, SC, and ST-Style connectors. SNMP Managed Ethernet Switches deliver management capabilities required by most network managers using interfaces such as direct connection to a console port, Telnet, or web browser sessions. Optional fiber or twisted pair uplinks can be added for high speed network interface. Fiber uplinks include single-mode and multimode (50 or 62.5/125 μm) Gigabit (1000BASE-SX or LX) and 100BASE-FX. Optional twisted pair uplink is via an RJ45, 100/1000BASE-T interface. These uplinks can be used in any combination on the switch to deliver a highly flexible backbone solution.

With an emphasis on high quality, competitive cost, and ease of use, AMP NETCONNECT Ethernet Switches are a great choice for anyone from a home office user to an enterprise IT manager.

5- and 8-Port Compact Ethernet Switch

7



A



B

Product Facts

- Compact and easy to install Ethernet switches
- Ideal for Small Office/Home Office (SOHO), small business and home networking applications
- Supports 10BASE-T and 100BASE-TX Ethernet applications
- For use with RJ45, shielded or unshielded, Category 6, 5e and 5 twisted pair structured cabling systems
- Data rate auto-negotiation and full or half duplex mode auto-selection
- Auto MDI/MDI-X detection eliminates the need for crossover cable assemblies
- Strong metal case helps to protect the switch against damage
- Powered via a compact external AC power adapter

Description		Figure	Part Number
Compact Ethernet Switch	5-Port	A	1591090-1
	8-Port	B	1591036-1

16- and 24-Port Compact Ethernet Switch



A



B

Description		Figure	Part Number
Compact Ethernet Switch	16-Port	A	1591070-1
	24-Port	B	1591072-1

Product Facts

- Compact and easy to install Ethernet switches
- 16-Port Compact Ethernet Switch is ideal for small office/business and home networking applications
- 24-Port Compact Ethernet Switch is ideal for medium sized office/business applications
- Supports 10BASE-T and 100BASE-TX Ethernet applications
- For use with RJ45, shielded or unshielded, Category 6, 5e, and 5 twisted pair structured cabling systems
- Data rate auto-negotiation and full or half duplex mode auto-selection
- Auto MDI/MDI-X detection eliminates the need for crossover cable assemblies
- Strong metal case helps to protect the switch against damage
- Powered via an internal, auto-ranging AC/DC power unit
- Can be mounted in either 10" or 19" frames
- Optional brackets for standard 19" rack mounting included

AMP NETCONNECT Smart Ethernet Switches

AMP NETCONNECT Smart switches can be configured using the local console port to control functions such as VLAN assignments and port enable/disable modes. This capability is ideal for network managers who want a basic level of network control.

Product Facts

- Supports 10BASE-T and 100BASE-TX Ethernet applications
- For use with RJ45, shielded or unshielded, Category 6, 5e and 5 twisted pair structured cabling systems
- Data rate auto-negotiation and full or half duplex mode auto-selection
- Auto MDI/MDI-X detection eliminates the need for crossover cable assemblies
- Strong metal case helps to protect the switch against damage
- Powered via an internal, auto-ranging AC/DC power unit
- Can be mounted in either 10" or 19" frames

8-Port Smart Ethernet Switches with Fiber Uplink Ports

7



Description	Fiber Uplink	Part Number
8-Port Smart Ethernet Switch	MT-RJ Multimode	1591042-1
	SC Duplex, Multimode	1591038-1
	SC Duplex, Single-mode	1591044-1
	ST Multimode	1591040-1
19" Mounting Brackets (Set of two)		1591068-0

Product Facts

- In addition to features at top, this switch:
- Ideal for linking small workgroups to remote servers or routers via integral fiber uplink port
- Basic port controls and VLAN settings are manageable via console port located on rear of unit
- Optional brackets for standard 19" rack mounting available separately
- Optical fiber uplinks:
 - Fiber uplink ports support 100BASE-FX applications and feature speed auto-negotiation and auto MDI/MDI-X detection eliminating the need for cross over cables
 - Compatible with 50/125µm and 62.5/125µm fiber types
- Available with Multimode MT-RJ, SC, ST, and Single-mode SC fiber uplink ports

24-Port Smart Ethernet Switch II with Optional Dual Uplink Port



Product Facts

- Supports 10BASE-T, 100BASE-TX, and Fast Ethernet standards
- Optional dual or single fiber uplink module only needs to be fitted if fiber link is required
- Fully managed Smart Switch II through the RS232 console port
- Supports up to 26 port-based VLANs
- Supports QoS (802.1p, DiffServ and port based)
- Programmable port speeds and duplex modes
- Supports full or half-duplex auto-negotiation together with N-Way capability on the RJ45 ports
- Auto-MDI/MDI-X support on each copper port
- Meets international safety and EMC approvals
- 2.5 Mb/s Memory buffer
- 8K MAC with Auto learning
- High speed 8.8Gb/s Back Plane

Description	Application	Interface Type	Part Number
24-Port Smart Ethernet Switch II			159 1093-X
Optional Uplink Port Modules	100BASE-Fx	SC Multimode Fiber	159 1094-0
		ST Multimode Fiber	159 1095-0
		SC Single-mode Fiber	159 1096-0
	Dual Gigabit	Multimode 1000BASE-Sx	159 1097-0
		Single-mode 1000BASE-Lx	159 1098-0
		Twisted Pair 1000BASE-T	2-159 1019-0

X denotes country/region: 1 = USA and Canada, 2 = Europe ex. Italy, Denmark and Switzerland, 3 = Switzerland, 5 = Denmark, 6 = Australia and New Zealand, 7 = UK, Ireland and Singapore, 8 = India and South Africa

AMP NETCONNECT SNMP Managed Ethernet Switches

AMP NETCONNECT SNMP Managed Ethernet Switches allow network managers excellent control and visibility of distributed switches using advanced functions accessible through a direct connection to the console port, Telnet or web browser sessions, or SNMP programs. This capability is ideal for network managers who want to have versatile control of their network.

24-Port Stackable Managed Switch with Optional Expansion Port



Product Facts

- Supports 10BASE-T, 100BASE-TX, and Ethernet applications
- Available uplink modules provide optional fiber 100BASE-FX or optical fiber or copper gigabit capabilities
- Supports full of half-duplex auto-negotiation together with N-Way capability on the RJ-45 port
- Auto-MDI/MDI-X eliminates the need for RJ-45 crossover cables
- Managed and controlled from a Console port, Telnet, SNMP or Web Browser
- IP stackable management supporting 8 separate switches
- VLANs, IGMP and QoS support
- Static MAC address port security
- Programmable bandwidth rules
- Comprehensive LED indicators
- Programmable port mirroring
- Up to 7 Port Trunks supported
- Supports 802-1x user authentication

7

Description	Application	Interface Type	Part Number	
24-Port Stackable Managed Switch			1591099-X	
Optional Uplink Port Modules	100BASE-Fx	SC Multimode Fiber	1591094-0	
		ST Multimode Fiber	1591095-0	
		SC Single-mode Fiber	1591096-0	
	Dual Gigabit		4-Fiber Multimode 1000BASE-Sx	1591097-0
			4-Fiber Single-mode 1000BASE-Lx	1591098-0
		2-Port Twisted Pair 1000BASE-T	2-1591019-0	

X denotes country/region: 1 = USA and Canada, 2 = Europe ex. Italy, Denmark and Switzerland, 3 = Switzerland, 5 = Denmark, 6 = Australia and New Zealand, 7 = UK, Ireland and Singapore, 8 = India and South Africa

AMP NETCONNECT Ethernet Media Converters

AMP NETCONNECT Ethernet Media Converters are high quality media conversion products that support 10BASE-T, 100BASE-TX and Gigabit (1000BASE-T) Ethernet standards and can be used in a wide range of applications including office buildings, professional workgroups, campuses, Fiber-to-the-Desk (FtD), and industrial systems.

Media Converters are used to extend Ethernet segments or LANs to servers and other network elements using single-mode or multimode (50 or 62.5/125 μm) optical fibers connectorized with the MT-RJ, SC, or ST connectors.

With a strong focus on simple, cost effective, quality installations, AMP NETCONNECT Media Converters enable a wide range of reliable network solutions.

Fast Ethernet Media Converters



Description	Part Number	
Fast Ethernet Media Converter	MT-RJ Multimode	1591028-1
	SC Duplex Multimode	1591024-1
	SC Duplex Single-mode	1591030-1
	ST Multimode	1591026-1

Product Facts

- Ideal for both new and legacy LAN applications
- RJ45 Port:
 - For use with shielded or unshielded, Category 6, 5e, and 5 twisted pair structured cabling systems
 - Supports 10BASE-T and 100BASE-TX Ethernet applications
 - Data rate auto-negotiation and full or half duplex mode auto-selection
 - Auto MDI/MDI-X detection eliminates the need for crossover cable assemblies
- Optical Fiber Port:
 - For use with MT-RJ, SC, or ST, Multimode or SC Single-mode optical fiber connectors
 - Multimode fiber ports are compatible with 50/125μm and 62.5/125μm fiber types
 - Supports 100BASE-FX Ethernet applications
- Increased network resilience through Link Loss forwarding function that allows suitable Ethernet switches to implement alternate paths when required
- Stand-alone or chassis mountable
- Strong metal case helps to protect the media converter against damage
- Powered via an external, AC power adapter
- Dimensions 4.7" x 3.4" x 1.0"

Ethernet Media Converters

Gigabit Ethernet Media Converters



Description	Part Number
1000BASE-SX SC Duplex Multimode	1591020-1
1000BASE-LX SC Duplex Single-mode	1591022-1

Product Facts

- Ideal for both new and legacy LAN applications
- RJ45 Port:
 - For use with shielded or unshielded, Category 6, 5e and 5 twisted pair structured cabling systems
 - Supports 1000BASE-T Ethernet applications data rate auto-negotiation and full or half duplex mode auto-selection
 - Auto MDI/MDI-X detection eliminates the need for crossover cable assemblies
- Optical Fiber Port:
 - For use with SC Multimode or single-mode fiber optic connectors
 - Multimode fiber ports are compatible with 50/125 μm and 62.5/125 μm fiber types
 - Supports 1000BASE-SX and 1000BASE-LX Ethernet applications
- Stand-alone or chassis mountable
- Strong metal case helps to protect the media converter against damage
- Powered via an external, AC power adapter
- Dimensions 4.7" x 3.4" x 1.0"

7

Rack Mount Media Converter Chassis System



Loaded

Description	Part Number
Rack Mount Media Converter Chassis System	1591032-1
Spare/Redundant AC Power Unit	1591034-0

NOTE: Media converters purchased separately

Product Facts

- Mounts in standard 19" racks
- 3U (5.25")
- Accepts up to ten (10) Fast Ethernet or Gigabit Ethernet Media Converters
- Ideal for enterprise critical and networks
- Can be loaded with mixed types of media converters for flexibility
- Media converters can be hot-swapped within the chassis
- Media converters are purchased separately
- Media Converter Chassis is shipped unloaded and includes one installed power supply
- A second power supply can be installed for a dual redundancy power system
- Power supplies can be hot-swapped for critical availability networks

250

AMP NETCONNECT Power over Ethernet Products

The AMP NETCONNECT 8-Port & 24 Port Power over Ethernet (PoE) Midspan device for 802.3af applications offers a per-port, cost-effective solution when powering remote devices like VoIP phones, WLAN access points, security devices, etc. The AMP NETCONNECT 8-Port and 24-Port PoE Midspan devices makes injecting DC power onto existing copper cabling as simple as routing patch cords and it eliminates the PoE costs for powered switch ports when power is not needed.

8-Port PoE Midspan Device



Product Facts

- IEEE 802.3af compliant
- Supports 10/100/1000 Mb/s Ethernet
- 19" metal frame mountable
- Universal 110/220 V (50/60 Hz) power supply
- Full Power on every port (15.4 W)

Description	Part Number
8-Port PoE Midspan	1591184-X
1U, 19" Mounting Frame (holds three 8-Port PoE Midspan Devices)	1591185-0

X denotes country/region: 1 = USA, Canada and parts of South-East Asia, 2 = Europe ex. Switzerland, Italy and Denmark, 3 = Switzerland, 4 = Italy, 5 = Denmark, 6 = Australia and New Zealand, 7 = UK, Singapore and Hong Kong, 8 = India

24-Port PoE Midspan Device



Product Facts

- IEEE 802.3af compliant
- Supports 10/100/1000 Mb/s Ethernet
- 185W Total Power
- Optional Power Upgrade
- Optional Phantom Power version available

Description	Part Number
24-Port PoE Midspan Device, unused pairs, w/o management	0-1591187-X
24-Port PoE Midspan Device, unused pairs, with management	1-1591187-X
24-Port PoE Midspan Device, phantom power, w/o management	2-1591187-X
24-Port PoE Midspan Device, phantom power, with management	3-1591187-X

X denotes country/region: 1 = USA, Canada and parts of South-East Asia, 2 = Europe ex. Switzerland, Italy and Denmark, 3 = Switzerland, 4 = Italy, 5 = Denmark, 6 = Australia and New Zealand, 7 = UK, Singapore and Hong Kong, 8 = India

Notes

7

252

LABELING & IDENTIFICATION

Labeling Software	255
Standard Labels for Outlets	255
Label Covers for Faceplates	256
Universal Labels	256
Labels for Patch Panels	257
Label Covers for Patch Panels	257
Labels for Cross-Connect Wiring Blocks	258
Label Holders for Cross-Connect Wiring Blocks	258
Labels for Cables and Cable Assemblies	259
Icon Wheels	259

Chapter Summary

- Labeling Software
 - TIA/EIA-606-A compliant
 - Microsoft® Windows® compatible
 - Context-sensitive help
 - Label templates specifically for AMP NETCONNECT cabling products
 - User-friendly wizard helps create identifiers with up to 12 independent elements
- Labels
 - 8.5" x 11" Sheet format
 - High-quality card stock and self-adhesive polyester
 - Compatible with most printers
 - Pre-cut or perforated for faceplates, patch panels, cross-connects and cable

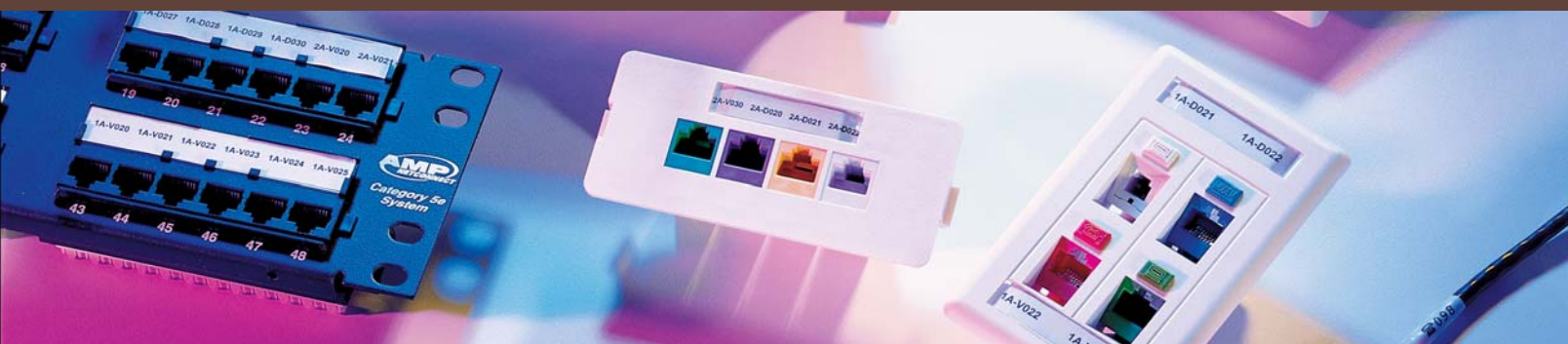

Labeling & Identification Information
Faceplate/Outlet and Label Compatibility List

		Card Stock 1375356	Self-adhesive Polyester 1375357	Label Cover 1375345	Label Cover 1479268	Self-adhesive Polyester 1375358	Self-adhesive Polyester 1375353
SL Series Modules (Chapter 3)	1116406	-	-	-	-	X	-
	1116408	-	-	-	-	X	-
SL Series Faceplates (Chapter 3)	1339118	X	X	X	X	-	-
	1479486	X	X	X	X	-	-
Standard Faceplates (Chapter 3)	557505	X	X	X	X	-	-
	557502	X	X	X	X	-	-
	558088	X	X	X	X	-	-
	83935	X	X	X	X	-	-
	557691	X	X	X	X	-	-
	83936	X	X	X	X	-	-
Angled Faceplates (Chapter 3)	558086	X	X	X	X	-	-
	1375155	X	X	X	X	-	-
HIDEOUT Outlet (Chapter 3)	406185	X	X	X	X	-	-
	503999	-	-	-	-	-	X
HIDEAWAY Multimedia Outlets (Chapter 3)	503997	-	-	-	-	-	X
	503998	-	-	-	-	-	X
Multimedia Security Outlet (Chapter 3)	1479815	X	X	X	X	-	-
	1479946	X	X	X	X	-	-
Surface Mount Outlet (Chapter 3)	1116535	-	-	-	-	-	-
Surface Mount Outlet Accessories (Chapter 3)	557366	-	-	-	-	-	-
	1116098	-	-	-	-	-	-
Universal Office Boxes (Chapter 3)	557775	-	-	-	-	-	-
	1479488	-	-	-	-	-	X
	1479489	-	-	-	-	-	X
12-Port Universal Office Box (Chapter 3)	1479490	-	-	-	-	-	X
	1479358	X	X	X	X	-	-
Modular Jack Boxes (Chapter 3)	1116697	-	-	-	-	X	-
	1116698	-	-	-	-	X	-
WIREMOLD Raceway Faceplates (Chapter 3)	1375050	X	X	X	X	-	-
	1375049	X	X	X	X	-	-
SL Series Furniture Outlets (Chapter 3)	1375005	-	-	-	-	X	-
	1375006	-	-	-	-	X	-

Labeling Software & Labels for Work Area

AMP NETCONNECT Labeling Software

VISIT WWW.AMPNETCONNECT.COM/LABELING TO DOWNLOAD A FREE 30-DAY TRIAL COPY!

VISIT WWW.AMPNETCONNECT.COM/LABELING AND CLICK THE "CLICK HERE TO BUY" BUTTON TO ORDER SOFTWARE FROM SILVER FOX, LTD!

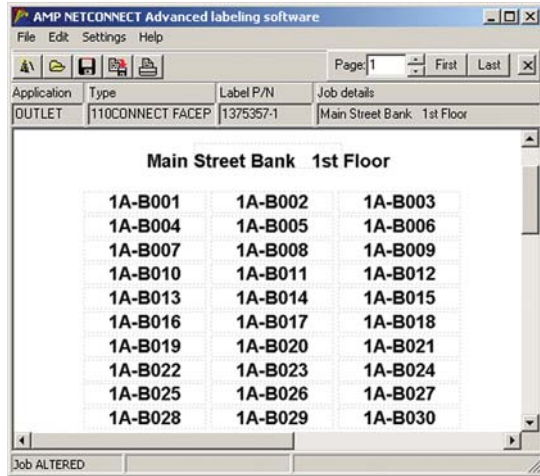

Product Facts

- Compatible with Windows 95, 98, 2000, Windows NT and Windows XP operating systems
- Flexible build option to produce more complex alphanumeric identifiers
- Create identifiers consisting of up to 12 independent segments
- Can cope easily with the TIA/EIA-606-A standard identification sequences
- Insert symbols (all standard Windows symbols can be used)
- Save and edit builds
- Fine tune adjustment
- Split your label format as required
- Job notepad facility for builds saved to file
- Justify text
- Adjust font style and size
- Context-sensitive help

Standard Labels for Outlets



Product Facts

- Labels are designed to fit AMP NETCONNECT and similar faceplates and surface outlets
- Card stock labels are perforated and compatible with inkjet and laser printers
- Self-adhesive polyester labels are pre-cut and compatible with laser printers
- Labels are supplied on 8.5" x 11" sheets
- For use with:
 - 110Connect Faceplates
 - SL Series Faceplates
 - HIDEAWAY Multimedia Outlet
 - WIREMOLD Raceway Faceplates
 - Universal Office Box, 6-Port
 - Multimedia Security Outlet
 - ACO Faceplates

Description	Label Size (W x H)	Labels per Sheet	Part Number
Card Stock	1.98" x 0.373"	72	1375356-X
Self-adhesive Polyester	1.98" x 0.373"	72	1375357-X

X denotes packaging: -1 = 5 sheets (360 labels) per pack, 5--1 = 100 sheets (7200 labels) per pack

8

255

Labels for Work Area

Label Covers for Faceplates

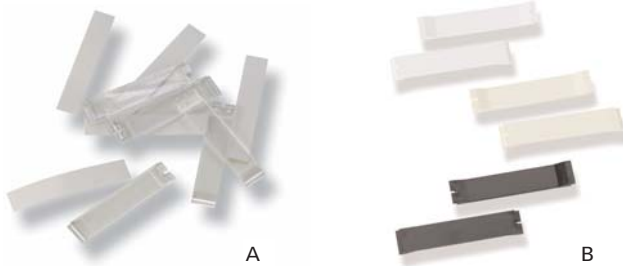

Product Facts

- Kit includes fifty die-cut labels and clear plastic covers
- For use in SL Series, 110Connect standard and angled, iconable ACO, and WIREMOLD compatible faceplates
- Can be used in place of clear label covers provided with SL Series and Standard and Angled 110Connect Faceplates
- Included with compatible faceplate kits

Description		Figure	Part Number
Label Cover	Transparent	A	1375345-1
	Opaque Color	B	1479268-X

X denotes color: -1 = Almond, -2 = Black, -3 = White, -4 = Gray, 1--1 = Electrical Ivory

Universal Labels



Product Facts

- AMP NETCONNECT Labeling Software allows customization of the universal labels listed for use with multiple products
- The Software provides cut lines to modify the labels for each particular application
- Number of labels per package will vary according to individual application

8

Description	Application	Labels per Sheet	Labels per Package		Part Number
			5 Sheets	100 Sheets	
Self-adhesive Polyester	Modular Jack Box, 1-Port	216	1,080	21,600	1375358-X
	Modular Jack Box, 2-Port	120	600	12,000	
	SL Series Furniture Outlet	72	360	7,200	1375353-X
	SL Series Faceplate, Double Gang				
	110Connect Office Box, 2-Port and 4-Port	144	720	14,400	

X denotes packaging: -1 = 5 sheets per pack, 5--1 = 100 sheets per pack

Labels for Telecommunications Room

Labels for Patch Panels



Product Facts

- All labels are designed to fit AMP NETCONNECT Standard and Angled patch panels
- AMPTRAC 6-Pack Patch Panels (Standard or Angled) use part number 1375353 labels only
- Labels are supplied on 8.5" x 11" sheets
- Card stock labels are perforated and compatible with inkjet and laser printers
- Self-adhesive polyester labels are pre-cut and compatible with laser printers
- Special 0.25" high label is provided for use when icons are also desired
- For use with:
 - 110Connect Cat 6 Patch Panels and Mini Patch Panels
 - 110Connect Cat 5e Patch Panels and Mini Patch Panels
 - 110Connect Cat 5 Patch Panels and Mini Patch Panels
 - SL Series Multimedia Patch Panels and Mini Patch Panels

Description	Label Size (W x H)	Labels per Sheet	Labels per Package		Part Number
			5 Sheets	100 Sheets	
Card Stock	3.10" x 0.50"	36	180	3600	1375351-X
Self-adhesive Polyester	3.10" x 0.50"	36	180	3600	1375352-X
	3.30" x 0.25"	72	360	7200	1375353-X

X denotes packaging: -1 = 5 sheets per pack, 5--1 = 100 sheets per pack

Label Covers for Patch Panels
PART NUMBER 1116044-2



Product Facts

- Includes twenty-five sheets, four clear plastic label covers per sheet
- For use with Category 6, 5e, 5 and SL Series Multimedia Patch Panels
- Included with compatible patch panels

8

257

Labels for Telecommunications Room

Labels for 610XC and 110Connect XC Cross-Connect Wiring Blocks

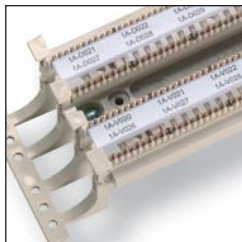

Product Facts

- Labels are designed to fit the AMP NETCONNECT 610XC and 110Connect XC Cross-connect systems and other similar products (Chapter 1.5)
- Card stock labels: designed to fit into standard clear designation strips, available in TIA/EIA-606-A compliant colors, perforated, and compatible with inkjet and laser printers
- White self-adhesive polyester labels: designed for easy application to the front of the clear designation strips, pre-cut and compatible with laser printers
- Labels are supplied on 8.5" x 11" sheets

Description	Label Size (W x H)	Labels per Sheet	Color	Part Number	
				5 Sheets	100 Sheets
Card Stock	7.90" x 0.48"	18	White	1375354-1	5-1375354-1
			Blue	1375354-2	5-1375354-2
			Green	1375354-3	5-1375354-3
			Purple	1375354-4	5-1375354-4
			Red	1375354-5	5-1375354-5
			Brown	1375354-6	5-1375354-6
			Yellow	1375354-7	5-1375354-7
			Orange	1375354-8	5-1375354-8
			Gray	1375354-9	5-1375354-9
Self-adhesive Polyester	7.90" x 0.48"	18	White	1375355-1*	5-1375355-1*

*Note: Available in white only.
NOTE: 5 Sheets per pack = 90 labels, 100 Sheets per pack = 1800 labels.

8

Clear Label Holder for 610XC and 110Connect XC Wiring Blocks
PART NUMBER 558417-1



Product Facts

- Used with 610XC and 110Connect XC Cross-Connect Systems (Chapter 1.5)

Labels for Cable and Cable Assemblies



Product Facts

- Labels are designed for use on cable and cable assemblies
- Labels are pre-cut and compatible with laser printers

Description	Application	Label Size (W x H)	Labels per Sheet	Labels per Package		Part Number
				5 Sheets	100 Sheets	
Self-adhesive Polyester	4-Pair Cable	0.984" x 1.496"	48	240	4800	1479002-X
	25-Pair Cable	0.984" x 2.480"	24	120	2400	1479003-X

X denotes packaging: -1 = 5 sheets per pack, 5--1 = 100 sheets per pack

Icon Wheels



- For use with:
 - SL Series Modules (Chapter 3)
 - SL Series Furniture Outlets (Chapter 3)
 - SL Series Mounting Straps (Chapter 3)
 - Modular Jack Boxes (Chapter 3)
 - Standard Faceplates (Chapter 3)
 - Universal Office Boxes (Chapter 3)
 - HIDEAWAY Outlet (Chapter 3)
 - HIDEOUT Outlet (Chapter 3)
 - Iconable ACO Faceplates (Chapter 3)
 - FLEX-MODE Electrical Faceplates (Chapter 3)
 - MT-RJ Rack Mount Enclosure (Chapter 2.5)
 - MT-RJ Snap-In Adapter Plate (Chapter 2.2)
 - SL Series Category 5E and 6 Patch Panels (Chapter 1.4)
 - 110Connect Category 5 and 5e
 - Patch Panels (Chapter 1.4)
 - SL Series Multimedia Jack Patch Panels (Chapter 3)
 - Iconable ACO Patch Panels (Chapter 1.4)
 - And other products as listed in each part's Product Facts

Each Wheel Contains:	Base Part Number
4 Data, 4 Blank, 2 Phone, 3 Cat 5, 1 Fax, 1 Modem, 1 Print	558176-X
4 Blank, 2 Cat 5e, 2 Cat 6, 1 each: V1, V2, V3, V4, D1, D2, D3, D4	1375092-X
16 Data	558198-X
16 Phone	558199-X
16 Blank, available in: -1, -6, -8, 1--0 and 1--1 only	558821-X

X denotes color: -1 = Almond, -2 = Red, -3 = Green, -4 = Blue, -5 = Yellow, -6 = Black, -7 = Orange, -8 = White, -9 = Violet, 1--0 = Gray, 1--1 = Electrical Ivory



Notes

8

260

ETHERSEAL CONNECTIVITY SYSTEM

EtherSeal Category 5e Cable	263
EtherSeal Modular Jack Outlet Kits	264
EtherSeal Modular Coupler Outlet Kits	264
EtherSeal Modular Plug Kits	265
EtherSeal Category 5e Patch Cable Assemblies	265
EtherSeal Fiber Products and Stainless Steel Faceplates	266
EtherSeal Enclosures	267
EtherSeal Cable & Conduit Glands	267

Chapter Summary

- TIA and ISO Category 5e and IEC 60529 IP67 compliant
- Uses industrial grade materials
- Uses the same high-performance AMP NETCONNECT Category 5e components as standard product lines
- Complete Cat 5e cabling solution for both harsh and office environments
- Equipment interface receptacles available through Tyco Electronics
- Positive latching mechanism
- Push-On and Twist Off Mating Action
- Blind mating with Polarized Keying
- Tactile feedback that confirms full mating
- Eliminates accidental disconnects when properly connected



EtherSeal Connectivity System Information

IP (Ingress Protection) Table

As specified by IEC 60529:2001-02 - Degrees of protection provided by enclosures (IP Code)

IP Code = IPXY

Protection from foreign objects

X 1	2	3	4	5	6
Protected from penetration of solid objects ≥ 50.0 mm \varnothing	Protected from penetration of solid objects ≥ 12.5 mm \varnothing	Protected from penetration of solid objects ≥ 2.5 mm \varnothing	Protected from penetration of solid objects ≥ 1.0 mm \varnothing	Partially protected dust. Dust shall not penetrate in quantities to interfere with proper operation or safety	Dust-tight

Protection from water

Y 1	2	3	4	5	6	7	8
Protected from vertically falling drops of water	Protected from vertically falling drops of water while enclosure is tilted up to 15° from vertical	Protected from water sprayed up to 60° from both sides of vertical	Protected from water splashed from all directions	Protected from jets of water spraying from all directions	Protected from powerful jets of water spraying from all directions	Protected from immersion in water for 30 minutes at a depth of 1 meter	Protected from continuous immersion in water for time and depths more severe than 7

Conversion of IP and NEMA Enclosure Ratings (including but not limited to the following)

IEC	IP10	IP11	IP54	IP14	IP54	IP56	IP52	IP67	IP52	IP54
NEMA	1	2	3	3R	3S	4 & 4X	5	6 & 6P	12 & 12K	13

Conversion of PG and Metric

PG Size and Thread Type	Metric Size and Thread Type	For Use With in (mm)
PG 11	M16 x 1.5	Cable 0.20 – 0.39 [5 – 10]
PG29	M32 x 1.5	3/4" Conduit 0.71 – 0.98 [18 – 25]
PG36	M40 x 1.5	1" Conduit 0.87 – 0.1.26 [22 – 32]

Category 5e FTP and UTP Cables

EtherSeal Category 5e Cable

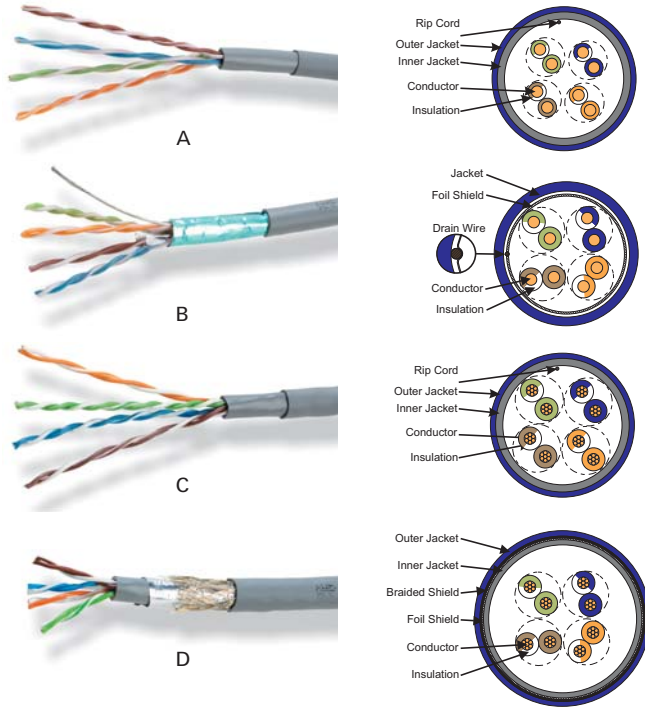

Product Facts

- Meets or exceeds TIA/EIA-568-B Enhanced Category 5 and ISO Class D 11801: 2002 specifications
- Meets or exceeds all requirements for Gigabit Ethernet
- Sunlight (UV) resistant for harsh environments
- Oil resistant, Level II
- Double jacketed - PVC
- CMR (Riser) rated
- Shielded and Unshielded - solid and stranded cables are available

UL/NEC Ratings	Pair Count	Jacket Color	Packaging	Conductor	Figure	Part Number	Weight lbs/kft	Vp (%nom)	*Dimensions (in)		
									Dielectric	Outside	
CMR	4	Grey	WR	Solid	UTP	A	1499447-3	30.0	71	0.018	0.250
					FTP	B	1499449-3	31.5	71	0.030	0.250
				Stranded	UTP	C	1499448-3	34.0	67	0.018	0.260
					ScTP	D	1499450-3	45.0	67	0.018	0.305

*Note: Dimensions reference outer jacketing.

Modular Jacks and Coupler Kits

EtherSeal Modular Jack Outlet Kits



Product Facts

- Meets or exceeds TIA and ISO component performance requirements
- IP67 Compliant
- Available for Shielded and Unshielded Systems
- Traditional 110 tool and toolless versions
- Front-loading into enclosures and outlets
- Push-On and Twist Off Mating Action
- Blind mate with Polarized Keying
- Tactile feedback confirms fully mated
- Optional Outlet Cap with tether available

Description			Figure	Part Number
SL Series 110Connect Modular Jack Kit	Category 6	Unshielded	A	1479565-2
		Shielded	B	1479566-2
	Category 5e	Unshielded	A	1479563-2
		Shielded	B	1479564-2
SL Series Toolless Modular Jack Kit	Category 5e	Unshielded	C	1479561-2
		Shielded	D	1479562-2
Modular Jack Cap			E	1479591-2
Positive Latching Modular Jack Cap			-	1479861-1

EtherSeal Modular Coupler Outlet Kits



Product Facts

- Meets or exceeds TIA and ISO component performance requirements
- IP67 Compliant
- Available for Shielded and Unshielded Systems
- Front-loading into enclosures and outlets
- Push-On and Twist Off Mating Action
- Blind mate with Polarized Keying
- Tactile feedback confirms fully mated
- Optional Outlet Cap with tether available

Description			Figure	Part Number
SL Series Modular Coupler Kit	Category 5e	Unshielded	A	1479599-2
		Shielded	-	1479600-2
Modular Jack Cap			B	1479591-2
Positive Latching Modular Jack Cap			-	1479861-1

Modular Plug Kits and Cable Assemblies

EtherSeal Modular Plug Kits



Description		Figure	Part Number	
Modular Plug Kit	Category 6	Unshielded	A Solid	1479682-2
			A Stranded	1479683-2
	Category 5e	Unshielded	B Solid	1479583-2
			B Stranded	1479584-2
		Shielded	C Solid	1479585-2
			C Stranded	1479586-2
Modular Plug Cap		D	1479592-2	

Product Facts

- Meets or exceeds TIA and ISO component performance requirements
- IP67 Compliant
- Available for Shielded and Unshielded Systems
- Available for solid and stranded cable
- Push-On and Twist Off Mating Action
- Blind mate with Polarized Keying
- Tactile feedback confirms fully mated
- Optional Plug Cap with available tether
- Category 6 Modular Plug Kit can be used for either shielded or unshielded applications.

EtherSeal Category 5e Patch Cable Assemblies



Product Facts

- Meets or exceeds TIA and ISO component performance requirements
- IP67 Compliant
- Utilizes EtherSeal, industrial grade Cat 5e cable
- Factory-terminated and tested for quality
- Both EtherSeal to EtherSeal and EtherSeal to standard modular plug versions available
- Push-On and Twist Off Mating Action
- Blind mate with Polarized Keying
- Tactile feedback confirms fully mated
- Optional Plug Cap with tether available

Description	Part Number	
EtherSeal to EtherSeal	Unshielded	1479601-X
	Shielded	1479603-X
EtherSeal to Standard RJ45 Modular Plug	Unshielded	1479602-X
	Shielded	1479604-X
Modular Plug Cap	1479592-2	

X= Denotes length in feet: -3 = 3, -5 = 5, -7 = 7, 1--0 = 10, 1--5 = 15

Fiber Products and Stainless Steel Faceplates

OVDA Duplex LC Receptacles and Plugs

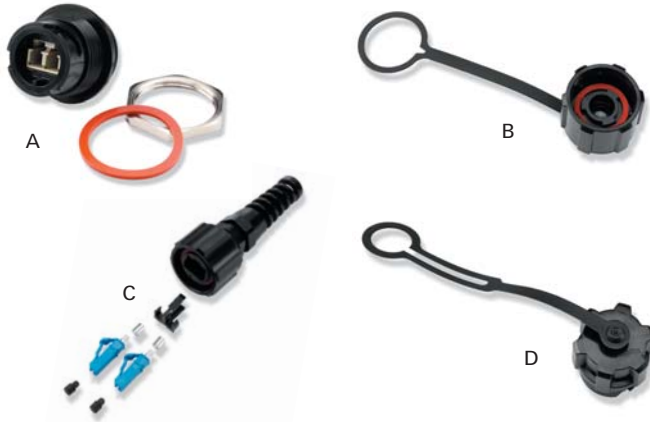

Product Facts

- Meets or exceeds TIA and ISO component performance
- IP67 compliant
- Bayonet style latching
- Multimode and Single-mode
- Epoxy/polish LC connector with plug kit

Description	Figure	Part Number
OVDA Duplex LC Receptacle, Multimode	A	1828619-1
OVDA Duplex LC Receptacle, Single-mode	-	1828619-2
OVDA Duplex LC Receptacle Dust Cap	B	1918177-1
OVDA Duplex LC Plug, Multimode	-	1828618-1
OVDA Duplex LC Plug, Single-mode	C	1828618-2
OVDA Duplex LC Plug Dust Cap	D	1828740-1

EtherSeal Stainless Steel Faceplates

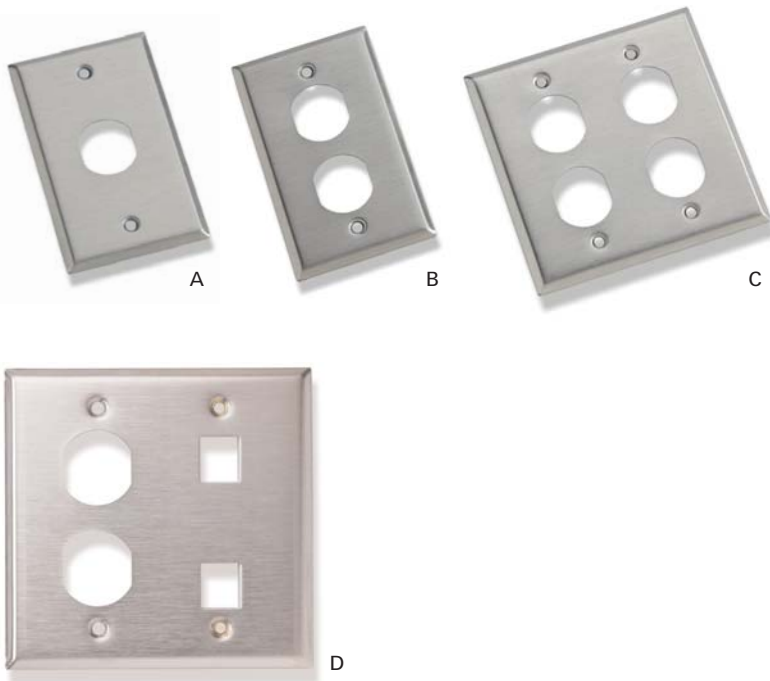

Product Facts

- Available in single and double gang
- Accepts EtherSeal Jack or Coupler Kits (purchased separately)
- Available with and without sealing gaskets
- Part Number 1479596 accepts two ports of EtherSeal Outlet Kits and two ports standard SL Series or 110Connect Jacks, and SL Series Multimedia Inserts



Description	Figure	Part Number		
		With Gasket	Without Gasket	
Single Gang	1-Port	A	1479593-2	1479593-1
	2-Port	B	1479594-2	1479594-1
Double Gang	4-Port	C	1479595-2	1479595-1
	2-Ports/2-Ports	D	1479596-2	1479596-1

EtherSeal Enclosures

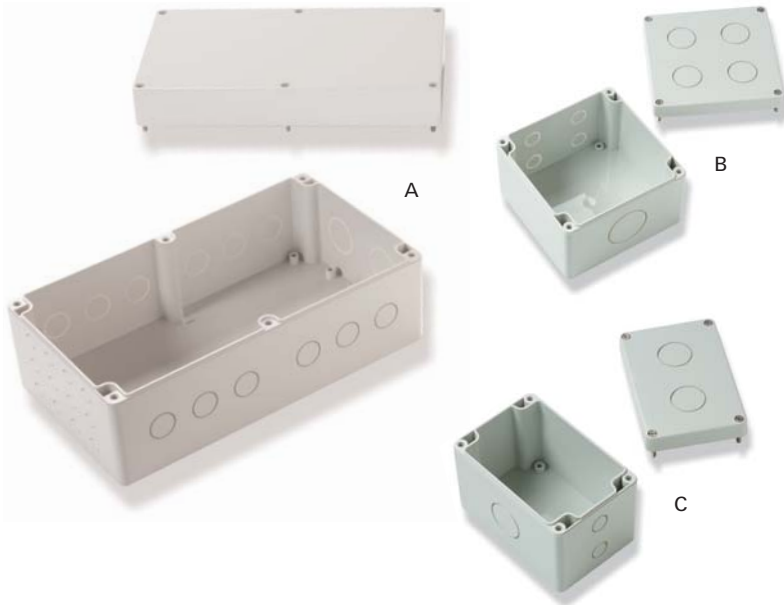

Product Facts

- NEMA 6 and 6P rated
- IP67 compliant when installed per instruction sheets
- Can be used in either indoor or outdoor environments
- Provides fully sealed remote access to data and telephone services
- Knockouts provide easy configuration for customer requirements
- Knockouts per enclosure as listed
- Cable and conduit glands provide a way to seal cable and or conduit entries



Description	EtherSeal	Knockouts			Figure	Part Number
		Cable	Conduit			
		M16	M32	M40		
Enclosure, Indoor/Outdoor	12	12	-	2	A	1479654-1
	4	4	-	1	B	1479655-1
	2	2	1	-	C	1479656-1

EtherSeal Cable & Conduit Glands



Product Facts

- Cable and conduit glands provide a way to seal cable and or conduit entries into EtherSeal Connector Enclosures

Description	For use with	Figure	Part Number	
Gland Kits	M16	Cable	A	1479657-1
	M32	3/4" Conduit	B	1479658-1
	M40	1" Conduit	C	1479659-1



Notes

9

268

POWER AND UNDERCARPET PRODUCTS

AMPINNERGY Modular Power Distribution System 270
 Raised Access Floor/Zone Wiring Distribution System 270
 Non-Metallic Sheathed Cable Interconnections 271
 Undercarpet Power and Communications Systems 272
 Undercarpet Power System 272
 Undercarpet Communications Systems 273
 Undercarpet Conference Room Kits 273

Chapter Summary

- AMPINNERGY - Modular power distribution system for business and retail store applications
- Undercarpet Power and Communications systems - for business and retail power and data distribution under carpet squares
- For part numbers and additional information for Power and Undercarpet Products, call 1-800-533-0938 and request document 1654963, or visit www.ampnetconnect.com/power

10



AMPINNERGY Modular Power Distribution System

AMPINNERGY Modular Power Distribution System



The AMP NETCONNECT AMPINNERGY Modular Power Distribution System can be used to deliver power to workstations in raised floor installations through AMP NETCONNECT Access Floor Workstation Modules, Modular Office Systems Furniture Panels, retail store display fixtures and other

methods as allowed by the NEC, CEC and local electrical codes. It may also be used to power 120 V overhead lighting fixtures.

The Modular Wiring System is available in 5-wire/3-circuit and 8-wire/4-circuit versions. The 5 and 8-wire versions have a 5.29 mm (10 AWG) conductor (neutral) to accommodate higher currents due to triplen harmonics. The 8-wire configuration has a separate 3.32 mm (12 AWG) neutral and isolated ground for the fourth circuit to allow an isolated, dedicated circuit for equipment sensitive to powerline noise.

Product Facts

- Layout and planning manual (124235) available for your CAD designer
- CAD layout and design services also available directly from Tyco Electronics
- Contact AMP NETCONNECT Customer Service for Construction Specifications Institute (CSI) or construction Specifications Canada (CSC) format
- Certified to Canadian Standards Association 22.2 (42) and (203) standards
- Compatible with 2005 National Electrical code (NEC) sections 604, 605 and 300-22(c)
- Compatible with 2002 Canadian Electrical Code (CEC) sections 12-2500 and 12-010
- AMPINNERGY System is rated 20 Amps per circuit - 125/250 VAC
- Listed under Underwriters Laboratories, Inc. 183, 498 and 1286

For part numbers and additional information, call 1-800-533-0938 and request document 1654963. Or visit www.ampnetconnect.com/power



Raised Access Floor/Zone Wiring Distribution System for UL 183 Listed Manufactured Wiring System Applications



The AMPINNERGY Raised Access Floor/Modular Zone Wiring Distribution System can be designed into any NEC rated 300-22(c) raised flooring application using Power Distribution Modules (PDMs) and/or Pre-Wired Zone Distribution Kits.

Product Facts

- Each Zone supports up to 27 Workstations
 - Up to six 6-Port Power Distribution Modules
 - 27 Access Floor Workstation Modules (AFWM) with 2 Duplex Receptacles
 - 4 - 6 duplex receptacles per circuit
- Each Zone supports up to 12 Circuits
 - Three may be dedicated
 - 5- and 8-wire capability
- Reusable and reconfigurable
- Plug and Play design reduces installation time and expense
- Easy to install - reduced installation time and expense
- The system design allows for dedicated or isolated ground circuits
- All components are factory assembled, tested and are UL 183 Listed
- Can be integrated with zone communication wiring systems
- Flexible cable saves installation labor up to 40%

All system interconnection is accomplished by using AMPINNERGY pre-connectorized 5- or 8-wire cable assemblies to provide a complete plug and play system that can be reused when system relocation or changes are required.

Access Floor Workstation Modules (AFWMs) can be factory pre-wired to meet the design requirements or site wired with an AMPINNERGY line entry cable assembly that will interconnect to all AMPINNERGY 5- and 8-wire cable assemblies.

Each pre-wired Zone Distribution Kit is designed to supply 240 amps in an available 12 circuit - 20 Amp per circuit configuration.

Each PDM is designed to supply 60 or 80 Amps in a 3 or 4 circuit - 20 Amps per circuit configuration.

10

270

Non-Metallic Sheathed Cable Interconnections

The AMP NETCONNECT Non-Metallic (NM) Sheathed Cable Interconnections provide a fast and reliable way to permanently interconnect 3.23 or 2.07 mm² (12 and 14 AWG) circuits. They eliminate the need for junction boxes, covers, wire nuts and box connectors.

NM Cable Splices and Taps use insulation displacement contacts (IDC) and require no special tools for termination.

Product Facts

- Voltage rating – 300 VAC RMS
- Current rating – 20 Amperes
- Temperature rating – 105 C
- Meets requirements of NEC 2002 articles 545, 550, 551 and 334-40B (Tap and 3-Wire Interconnection)
- UL Listed, file number – E57250



Undercarpet Power and Communications Systems

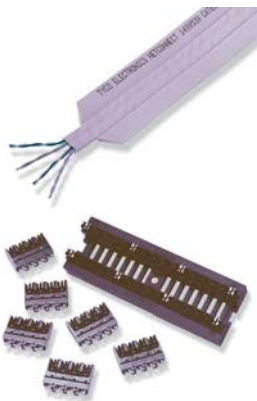

The AMP NETCONNECT Undercarpet Cabling system is a low profile, flexible system that makes even the most complex cabling job in an office or retail environment simple, economical and beautifully invisible. The cabling to provide power, voice and data services to your equipment can be handled with ease - from desk lights to network connections. And it's changeable! If changes are required after the initial installation, don't worry about the cabling. You can change it to fit your new requirements just about

as easily as you move the furniture or retail display fixtures.

Take up a few sections of the carpet squares, change the routing of the Undercarpet cables and relocate the floor fittings. Presto! You're back in business. With this system, all your power, voice and data networks can be routed virtually anywhere under the carpet without the restrictions encountered with underfloor ducts, walls, partitions and power/data poles.

Primary applications

- Ideal for Retail Stores
- Highly suited for the "Store-in-a-box" Concept since all power, voice and data cabling can be pre-packaged in one box.
- Slab-on-grade, first floor areas
- Open lobby or customer reception areas
- Areas not easily accessible by traditional cabling methods

Power and Communications System Facts

- Eliminates need for trenching floor, core drilling or unsightly power poles
- No need to disturb adjacent stores in shopping malls to gain access for pulling cables
- Better control of quality and work schedule

Undercarpet Power System

The AMP NETCONNECT Undercarpet Power System is a modern, flexible way to make the most complex cabling layout simple, economical and easy to handle. Whatever equipment may be needed can be cabled with ease. Building construction is possible without the extensive and costly electrical ductwork required for other systems.

The AMP NETCONNECT Undercarpet System can be installed directly on any level, continuous and relatively smooth floor surface of concrete, ceramic, composition or wood.

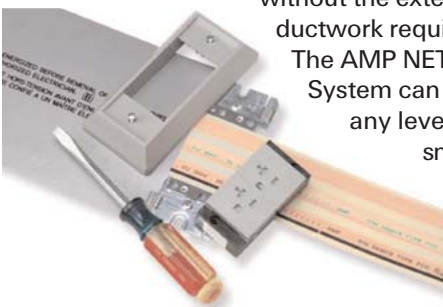

What could be simpler? No "poking" through floors or setting up poles

to carry your cabling. Transition fittings on wall or columns or in the floor make connections with the central distribution panels. Flat cable can be folded at 90° angles to change direction. Insulation displacement connections and "insulating patches" simplify installation. And the wide variety of floor fittings lets you plug into the power lines wherever you like.

Products Required for Undercarpet Power Distribution

- Transition Box, either Flush, Surface or Floor
- Transition Block
- Undercarpet Power Cable
- Floor preparation*
- Top Shield
- Top Shield Bonding Clips
- Hold Down Tape
- Spray Adhesive
- Direct-connecting receptacles
- Power Whip Kit
- Flush Floor Service Box
- Flush Floor Outlet Box

*Note: Floor preparation is required for slab-on-grade installations, but is recommended for all installations.

Undercarpet Communications Systems



Reliable communication is essential to the modern business. The AMP NETCONNECT Undercarpet Communications System is a flexible method of bringing communications to a complicated office or retail layout. Simple, economical cabling allows voice

and data connection to be placed wherever they are needed. Like the Undercarpet Power System, the AMP NETCONNECT Undercarpet Communications System can be installed directly on any level, continuous and relatively smooth floor surface of concrete, ceramic, composition or wood. They system eliminates the need for ductwork, poke-throughs and even telepoles.

Simple transition boxes in the wall or floor provide easy connections to the round cables running from the telecommunications closet. Up to six 4-pair cables can be connected and run from a single wall box. The Undercarpet Communications System utilizes high performance TIA/EIA-568-B Enhanced Category 5 and Category 6 cabling for superior performance. A variety of floor fittings are available to support the 110Connect, SL Series and AMP Communications Outlet (ACO) Systems.

Product required for undercarpet communications distribution

- Transition Box
- Transition Box Cover
- Transition Block
- Undercarpet Communications Cable
- Hold Down Tape
- Floor Fitting
- Voice or Data Jacks

Undercarpet Conference Room Kit



If your requirements specify power, voice and data services in an open office or conference room application, the AMP NETCONNECT Undercarpet Conference Room Kit is the simple answer to a complex problem. This "Conference Room-in-a-Box" solution provides everything that is needed to

install or retrofit a single room with Undercarpet Power and Communications.

Tyco Electronics also offers a full line of AMP NETCONNECT communications (voice/data) connectivity and accessories. Whether you need to install power and communications systems on a raised floor or run an SVGA signal from your computer to a monitor/projector up to 35 feet away, Tyco Electronics offers a comprehensive line of AMP NETCONNECT products to complete the connection.

Notes

10

274

AMP NETCONNECT HOME NET-WORKS SYSTEM

AMP NETCONNECT HOME NET-WORKS SYSTEM

Outlet Kits	280
Outlet Faceplates, Jacks, Inserts and Cable	281
Connectivity Modules and Accessories	282
Connectivity Modules	283
Connectivity Kits	284
Connectivity Kits, Accessories and Cable Assemblies	285
Passive Video Modules	286
Active Video Modules	287
Video Distribution Accessories	288
A-BUS Audio System	289
RCS Media Convergence Centers	290-291
RCS MCC Accessories	292
Security Panels	292

Chapter Summary

- Color-coded plug-and-play patching: any outlet port can be easily configured for any application (voice, data, fax, etc.)
- Cat 5e or Cat 6 performance
- Aesthetic value: neat, organized, flexible
- Fast, effective terminations: with 110 punch-down technology that reduces labor and produces high-performance connections
- Everything needed to design and deliver a true structured cabling for voice, data, video and audio in modern homes

11



AMP NETCONNECT HOME NETWORKS SYSTEM INFORMATION

Planning Steps

- 1) Select outlet locations and configurations (TIA-570-B recommends either a 1+1 or 2+2 outlet configuration – 2+1 outlet configurations are available as intermediate solutions).
- 2) Calculate total number of outlet and service cables needed, and lengths required.
- 3) Select Cat 5e or Cat 6 (TIA-570-B recommends Category 6) connectivity panel(s) and video module(s) to support outlets and desired capabilities.
- 4) Select appropriate Media Convergence Center to accommodate connectivity panels and modules (RCS36 is recommended for maximum flexibility with video, voice and data as well as expansion capability).

Design Considerations & Recommendations

- A minimum of one outlet location should be cabled in each of the following rooms:
 - Kitchen
 - Bedroom
 - Family/Great Room
 - Den/Study
- Cables should be home run from outlets to the Media Convergence Center (MCC).
- The MCC should be centrally located in a climate-controlled location to minimize cable run lengths.
- Minimum recommended service cables to the MCC:
 - Two (2) Cat 5e/6
 - Two (2) RG6
 - Four (4) RG6 from digital satellite dish mounting location for Single Dwelling Units (SDUs)
- A 120VAC, 15A non-switchable duplex electrical outlet should be provided within the MCC.

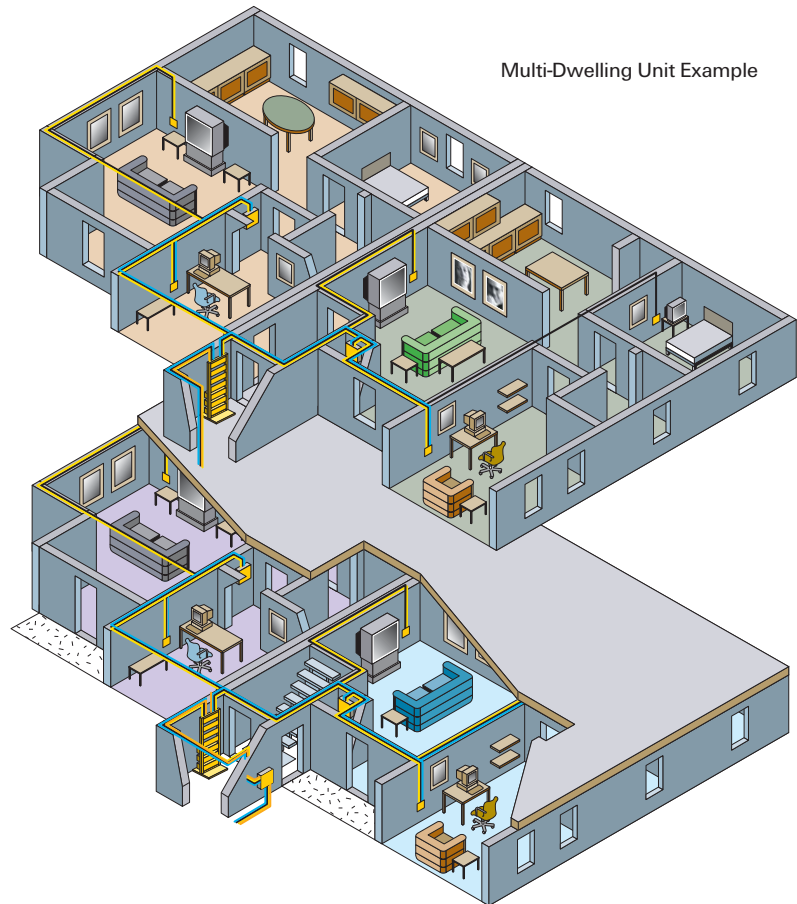

Design Considerations - FTTH

Typical System Layout

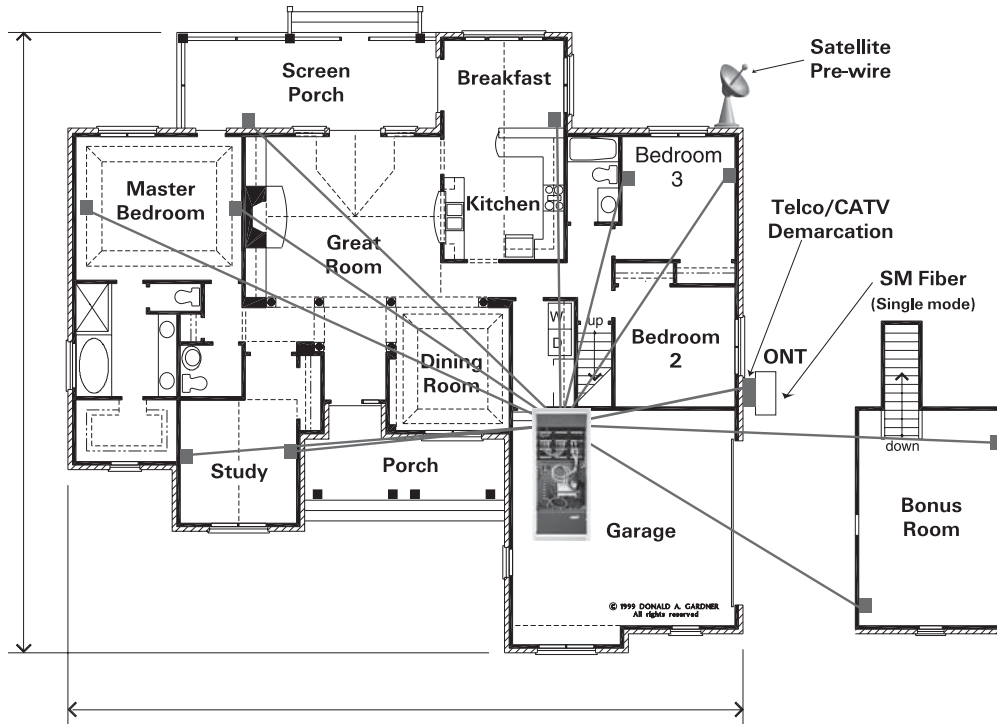

RCS 36

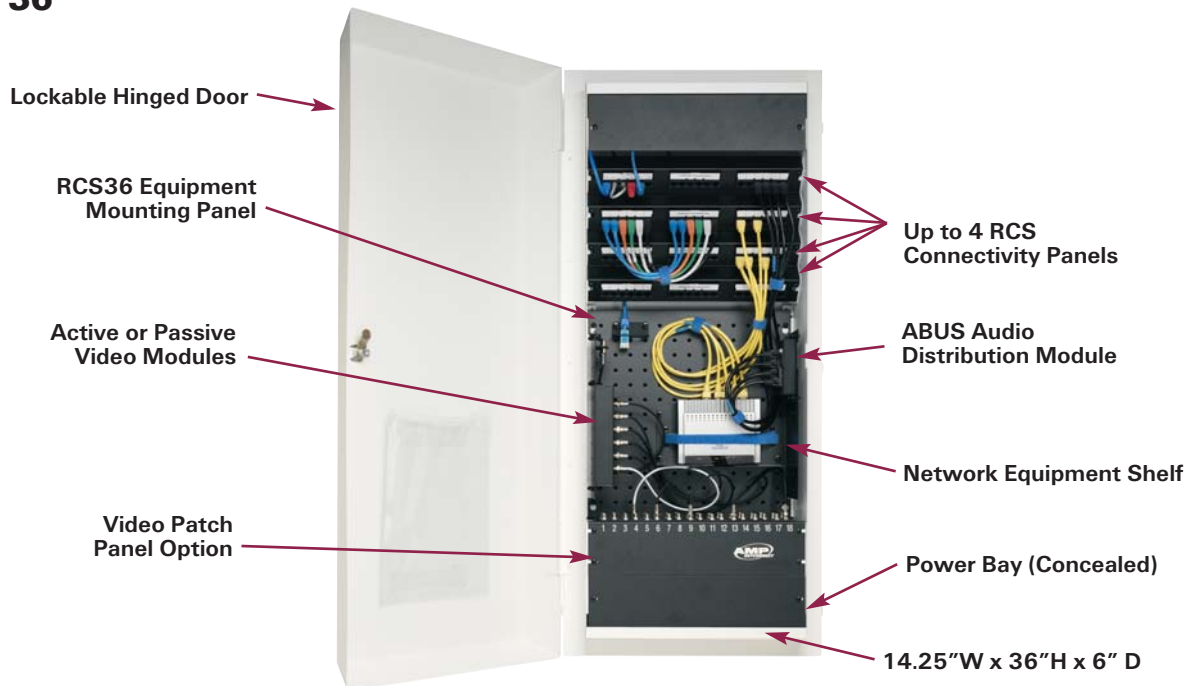

AMP NETCONNECT HOME NET-WORKS SYSTEM INFORMATION

RCS 28

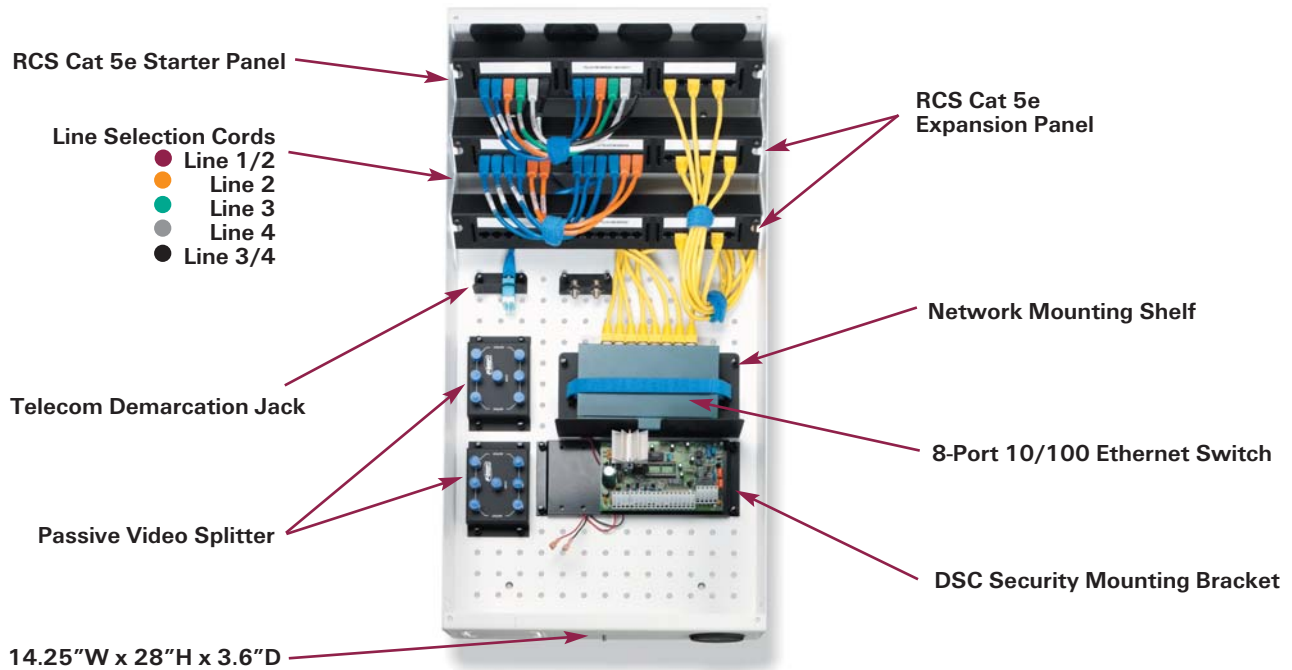

RCS 14

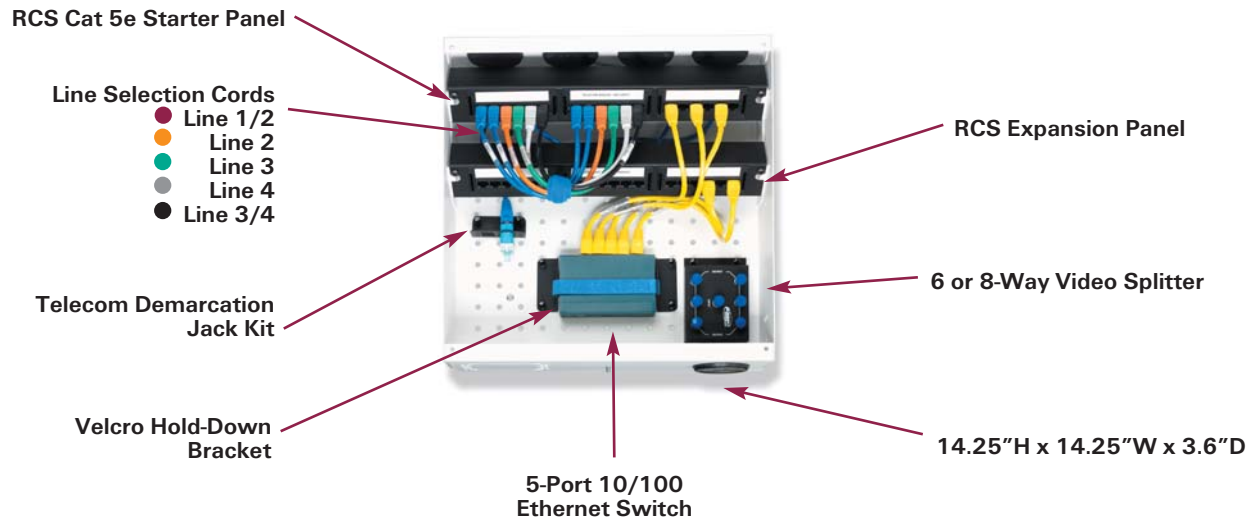

Color-Coded Plug & Play Connectivity

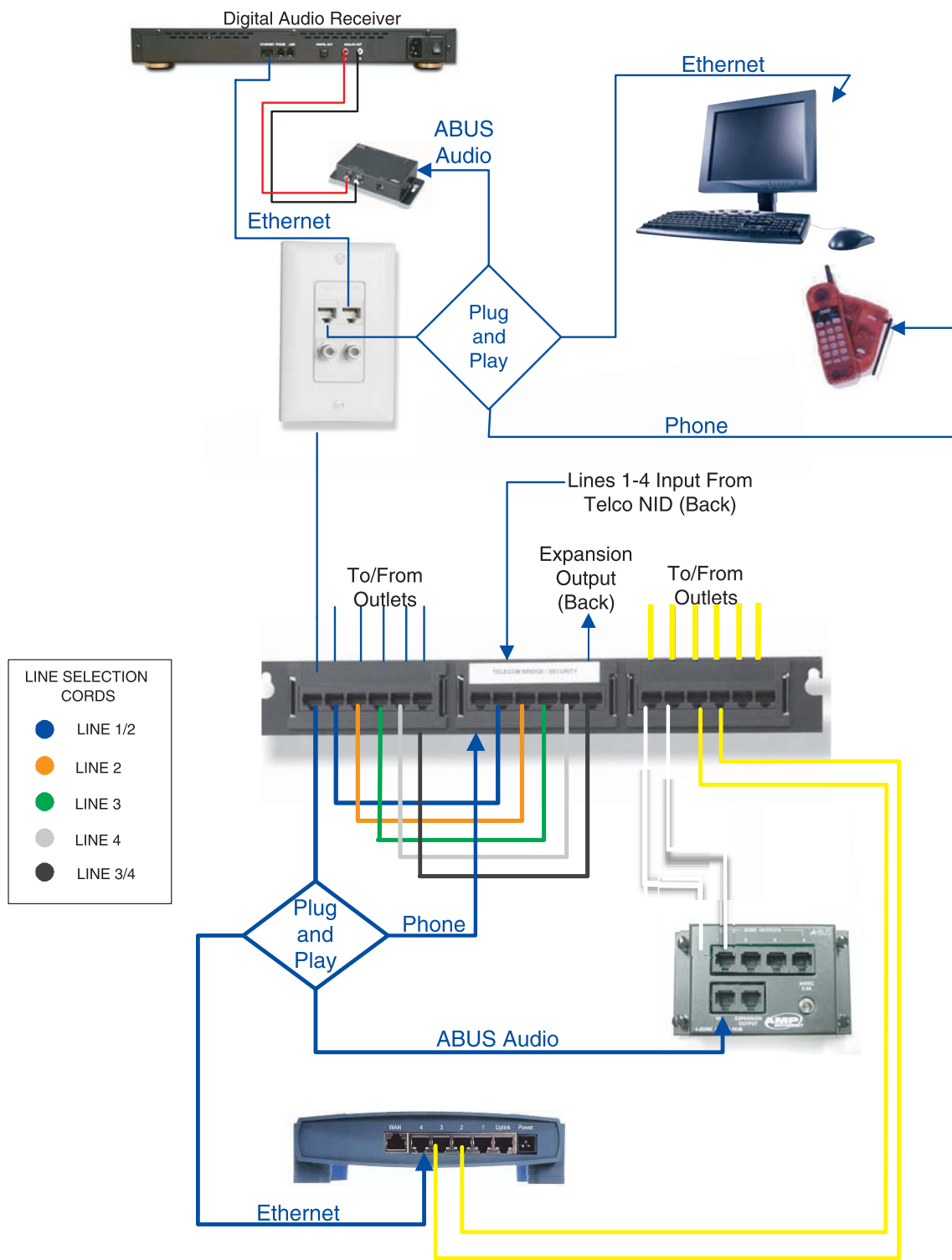

Outlet Kits

Three levels of connection capabilities at room outlets are available with kits providing increasing numbers of connections per outlet. All kits are available in Category 5e or Category 6.

1+1 Outlet Kits

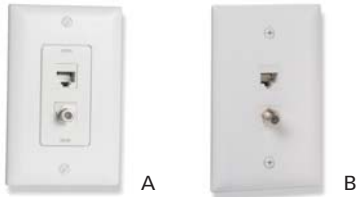

Description		Figure	Part Number
Decorator 1+1 Outlet Kits	Cat 5e	A	1479333-3
	Cat 6	A	1479348-3
Mid-Size 1+1 Outlet Kits	Cat 5e	B	1479844-3
	Cat 6	B	1479847-3

Product Facts

- Decorator-style or low-profile faceplate
 - One (1) SL Series 110Connect Modular Jack
 - One (1) F-Connector Coupler Insert
- Meets TIA/EIA-570-A Grade 1 requirements
- Acceptable for locations where only one Cat 5e/6 application is required at once (e.g., voice or data)

2+1 Outlet Kits

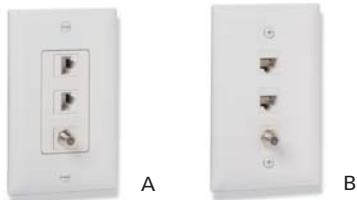

Description		Figure	Part Number
Decorator 2+1 Outlet Kits	Cat 5e	A	1479161-3
	Cat 6	A	1479349-3
Mid-Size 2+1 Outlet Kits	Cat 5e	B	1479845-3
	Cat 6	B	1479848-3

Product Facts

- Decorator-style or low profile faceplate
 - Two (2) SL Series 110Connect Modular Jacks
 - One (1) F-Connector Coupler Insert
- Exceeds TIA/EIA-570-A Grade 1 requirements
- Ideal for locations requiring multiple Cat 5e/6 applications (e.g., voice and/or data)

2+2 Outlet Kits



Description		Figure	Part Number
Decorator 2+2 Outlet Kits	Cat 5e	A	1479554-3
	Cat 6	A	1479555-3
Mid-Size 2+2 Outlet Kits	Cat 5e	B	1479846-3
	Cat 6	B	1479849-3

Product Facts

- Decorator-style or low profile faceplate
 - Two (2) SL Series 110Connect Modular Jacks
 - Two (2) F-Connector Coupler Inserts
- Meets TIA/EIA-570-A Grade 2 requirements
- Ideal for locations requiring multiple Cat 5e/6 applications (e.g., voice and/or data)
- Second F-connector coupler provides capability for distributing modulated video (e.g., from DVD player)

Outlet Faceplates, Jacks, Inserts, and Cable

Outlet Faceplates and Straps

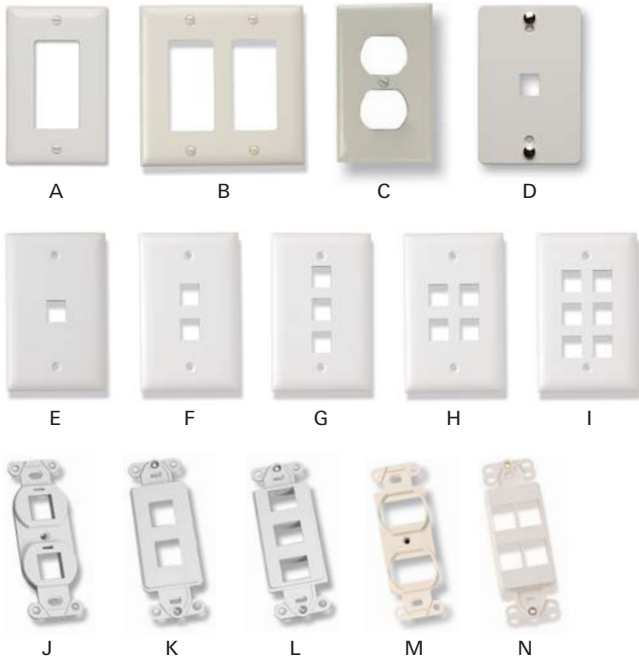

Description	Figure	Part Number
Decorator Faceplate	A	1479159-X
Dbt Gang Decorator Faceplate	B	1479625-X
Duplex Faceplate	C	1479160-X
Wall Mount Phone Faceplate	D	1479152-X
1-Port Faceplate	E	1479443-X
2-Port Faceplate	F	1479444-X
3-Port Faceplate	G	1479445-X
4-Port Faceplate	H	1479446-X
6-Port Faceplate	I	1479447-X
2-Port Duplex Strap	J	1116618-X
2-Port Decorator Strap	K	1479784-X
3-Port Decorator Strap	L	1116616-X
4-Port Duplex Strap	M	1339120-X
4-Port Decorator Strap	N	1479504-X

X denotes color: -1 = Almond, -2 = Black, -3 = White, -4 = Gray,
1--1 = Electrical Ivory

Outlet Jacks and Inserts

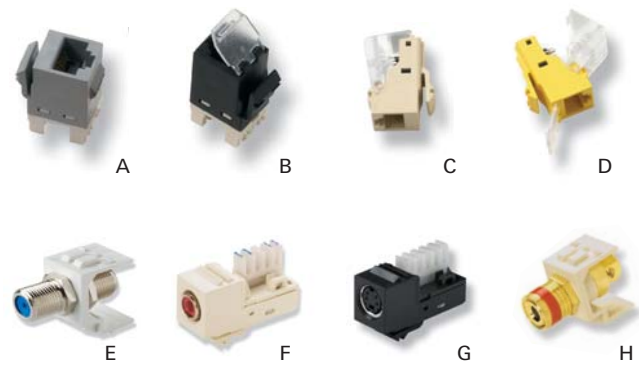

Description	Figure	Part Number
Cat 5e Jack	A	1375191-X
Cat 5e Jack w/Dust Cover	B	1375190-X
Cat 6 Jack	-	1375055-X
Cat 6 Jack w/Dust Cover	-	1375187-X
Cat 5e Toolless Jack	C	1116604-X
Cat 5e Toolless Jack w/Dust Cover	D	1339189-X
Blank Insert	-	1116612-Y
F-Connector Insert	E	1499855-Y
RCA 110 Jack (red)	F	1479230-Y
RCA 110 Jack (white)	-	1479231-Y
RCA 110 Jack (yellow)	-	1479232-Y
S-Video 110 Jack F	G	1375149-Y
Speaker Post (black)	-	1479190-Y
Speaker Post (red)	H	1479191-Y

X denotes jack color: 1 = Almond, -2 = Black, -3 = White, -4 = Gray,
-5 = Orange, -6 = Blue, -7 = Red, -8 = Yellow,
-9 = Green, 1--0 = Violet, 1--1 = Electrical Ivory

Y denotes insert housing color: -1 = Almond, -2 = Black, -3 = White,
-4 = Gray, 1--1 = Electrical Ivory

Outlet Cable



Description	Part Number
Cat 5e Cable, CMR (non-plenum)	219538-X
Cat 6 Cable, CMR (non-plenum)	219560-X

X denotes color: -2 = White, -6 = Blue, -8 = Yellow

Recommendation: Blue for voice, yellow for data, white for A-BUS audio.
Cable comes in 1000 ft. reels.

Connectivity Modules and Accessories

Connectivity panels contain the modules and ports for distribution of voice and data signals to room outlets. All are available in Category 5e or Category 6.

Unloaded Connectivity Panel & Accessories

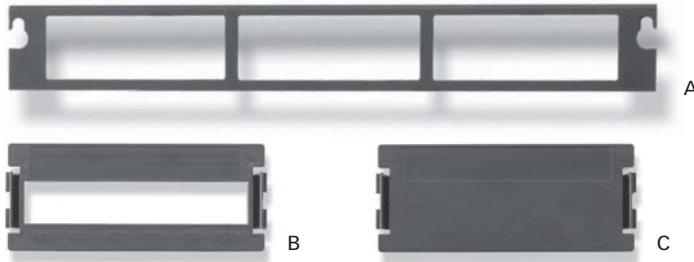

Description	Figure	Part Number
Unloaded Connectivity Panel	A	1479699-1
SL Interface Housing	B	1479697-1
Blank Filler	C	1479698-1

Product Facts

- Accepts the following front loadable snap-in modules:
 - 1479697-1, SL Interface Housing
 - 1479698-1, Blank Filler
 - 1479700-1, Cat 5e Connectivity Module
 - 1479701-1, Standard Telecom Bridge Module
 - 1479702-1, Telecom Bridge/Security Module
 - 1479703-1, DSL/Security Module
 - 1479865-1, 110 Telecom Bridge Module

Standard Telecom Bridge

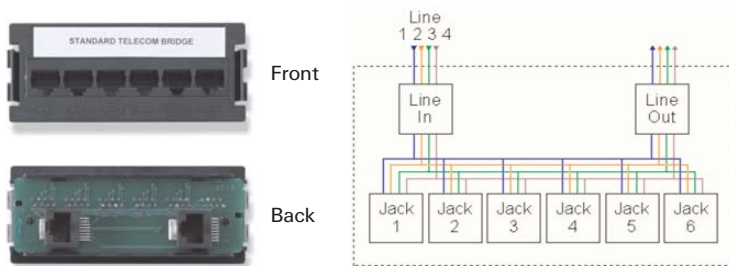

Description	Part Number
Front-Loadable Standard Telecom Bridge	1479701-1

Product Facts

- Six ports – four lines per port
- For basic telephone, fax and dial-up modem services
 - Bridge four incoming lines to six output ports
 - Expansion port allows additional bridging modules to be added
- 1 ft Cat 5e Expansion cord, 1499112-1

Telecom Bridge/Security

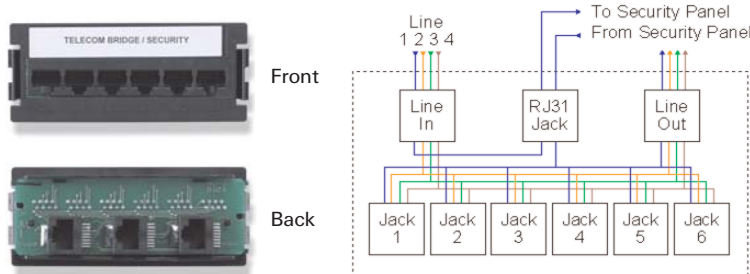

Description	Part Number
Front-Loadable Telecom Bridge/Security Module	1479702-1

Product Facts

- 6 ports – 4 lines per port
- Expansion port
- RJ31 security interface port
- For basic telephone, fax and dial-up modem service
- Includes RJ31 shorting plug
 - RJ31 plug loops line 1 back to panel if no security system currently is installed



RJ31 Plug

DSL/Security Module

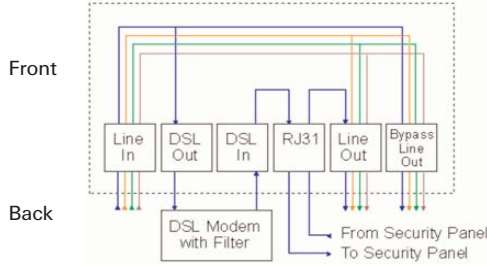

Product Facts

- Line 1 DSL output & filtered input ports
- Filtering accomplished by connecting a filtered phone output from DSL modem or optional in-line DSL filter to DSL Security Module DSL-IN port
- RJ31 security interface port
- For splitter-less DSL applications
- Includes RJ31 shorting plug and RJ14 telco jumper cord

Description	Part Number
Front-Loadable DSL/Security Module	1479703-1

Cat 5e Connectivity Module



Front
Back

Product Facts

- 6-port, RJ45 Cat 5e
- 110 punch down
- Voice or data applications
- Supports Gigabit Ethernet

Description	Part Number
Front-Loadable Cat 5e Connectivity Module	1479700-1

110 Telecom Bridge Module

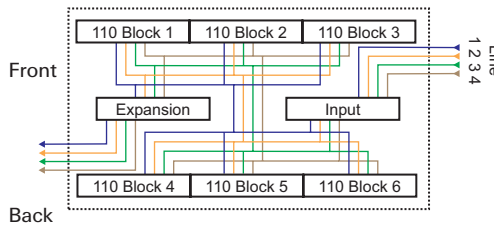

Front
Back

Product Facts

- 110 Punch down termination
- 4 lines x 7 outputs
- For basic analog phone, fax and dial-up modem

Description	Part Number
Front-Loadable Cat 5e Connectivity Module	1479865-1

Connectivity Kits

RCS Basic Starter Kit



Description	Part Number
RCS Entry Level Connectivity Kit	1479712-1

Product Facts

- Provides an 18-port panel with:
 - One (1) 6-port Cat 5e connectivity module
 - One (1) 6-port telecom bridge/security module (4 lines) per port with RJ31 port for security panel
 - One (1) Cat 5e Demarcation Jack
 - One (1) 1 GHz 6-way passive video splitter
 - Seven (7) Cat 5 4-pair 568A cables, blue, 1 ft
 - One (1) Line 2 telecom cable, orange, 1 ft
- Terminate up to six Cat 5e cables
- Any port can be configured for voice or data

RCS Connectivity Starter Kit



Description	Part Number	
RCS Connectivity Starter Kit	Cat 5e	1479704-1
RCS SL Connectivity Starter Kit	Cat 5e	1933057-1
	Cat 6	1479705-1

Product Facts

- Provides an 18-port panel with:
 - Two (2) 6-port connectivity modules
 - One (1) 6-port telecom bridge/security module (4 lines per port) with RJ31 port for security panel
 - Six (6) Cat 5 4-pair 568A cables, blue, 1 ft
 - Two (2) Line 2 telecom cables, orange, 1 ft 8" hook & loop cable tie, blue
- Terminate up to 12 Cat 5e/6 cables
 - Any 6 outlet ports can be configured for 4-line phone
 - All 12 ports can be configured for data
- SL Kit includes 12 SL style Jacks

RCS Connectivity Expansion Panel



Description	Part Number	
RCS Expansion Panel	Cat 5e	1479706-1
RCS SL Expansion Panel	Cat 5e	1933058-1
	Cat 6	1479707-1

Product Facts

- Provides an 18-port panel with:
 - Two (2) 6-port connectivity modules
 - One (1) 6-port standard telecom bridge module (4 lines per port)
 - One (1) Cat 5 4-pair 568A expansion cable, blue, 1 ft
- Terminate up to 12 additional Cat 5e/6 cables
 - Any 6 outlet ports can be configured for 4-line phone
 - All 12 ports can be configured for data
- Patch cables available separately
- SL Panel includes 12 SL style Jacks

Connectivity Kits, Accessories and Cable Assemblies

18-Port Patch Panel



Description	Part Number	
18-Port Patch Panel	Cat 5e	1479710-1
	Cat 6	1479711-1

Product Facts

- Includes:
 - Three (3) 6-port connectivity modules
 - Terminates up to 18 Cat 5e/6 cables
 - Cat 6 style panel includes (18) SL style Jacks

Demarcation Jack Kit

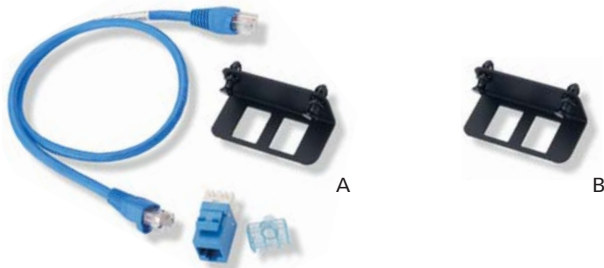

Description	Figure	Part Number
Demarcation Jack Kit	A	1479285-1
Demarcation Bracket (bracket only)	B	1479441-1

Product Facts

- Demarcation Kit includes:
 - Demarcation jack bracket
 - Cat 5e SL 110 Jack, blue
 - Cat 5e Patch Cable, blue, 2 ft
- Meets TIA/EIA-570-B requirements for Auxiliary Disconnect Outlet
- SL Series Bracket accepts (2) Cat 5e/6 SL Series Jacks for incoming data service demarcation
- Recommend blue jacks for voice and yellow for data

Patch Cords

Description	Color	Length (ft)	Part Number
Cat 5e Patch Cord	Yellow	2	219246-2
	White	2	219245-2
Cat 5e Equipment Cord	White	8	219245-8
Cat 6 Patch Cord	Yellow	2	219890-2
Cat 6 Equipment Cord	White	8	219889-8
Cat 5 Equipment Cord	Blue	1	1479557-1

Product Facts

- Standard patch cables for data patching and outlet connections
- Recommend yellow for data and white for A-BUS audio distribution

Telephone Line Designation Cords

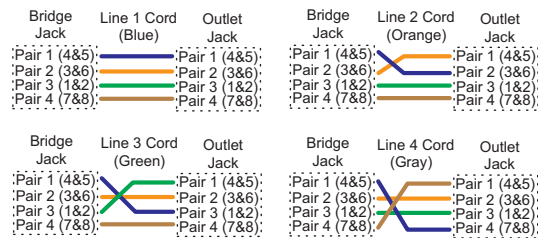

Description	Color	Part Number
Line 1/2 Telecom Cord	Blue	1479557-1
Line 2 Telecom Cord	Orange	1479004-1
Line 3 Telecom Cord	Green	1479005-1
Line 4 Telecom Cord	Gray	1479006-1
Line 3/4 Telecom Cord	Black	1479556-1

Product Facts

- Designates primary line selection
- Line 1 is secondary for line cords 2-4 except line 3-4 cord where line 4 is secondary

Passive Video Modules

AMP NETCONNECT HOME NET-WORKS SYSTEMS passive and active video modules provide a flexible and easy method for distributing high-quality RF signals throughout an installed AMP NETCONNECT HOME NET-WORKS SYSTEM coaxial distribution system. AMP NETCONNECT HOME NET-WORKS SYSTEM video modules feature push-pin latch installation; just put the video module into place on the mounting grid and press the push-pins in to mount.

Passive Video Modules

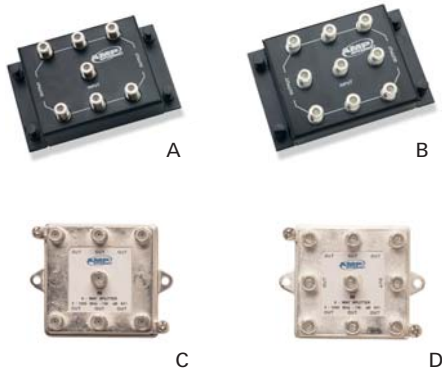

Product Facts

- Passive video modules (PVMs) provide the capability to distribute one RF input to six to eight locations on an installed coaxial distribution system
- May also be used as combiners for multiple modulated RF sources
- DC passing all ports
- Feature either push-pin mounting (for mounting on equipment panels) or screw mounting (for mounting on backboards without mounting holes)

Description	Mounting Method	Inputs	Outputs	Frequency Range	Figure	Part Number
Passive Video Modules	Push-Pin	1	6	1 GHz (5 – 1000 MHz)	A	1479334-1
			8	2 GHz (5 – 2450 MHz)	A	1479772-1
			6	1 GHz (5 – 1000 MHz)	B	1479335-1
			8	2 GHz (5 – 2450 MHz)	B	1479773-1
	Screw (Direct Mount)	1	6	1 GHz (5 – 1000 MHz)	C	1375398-1
			8	2 GHz (5 – 2450 MHz)	C	1479770-1
			6	1 GHz (5 – 1000 MHz)	D	1479372-1
			8	2 GHz (5 – 2450 MHz)	D	1479771-1

Passive Video Module Performance

	1 GHz Passive Video Modules			2 GHz Passive Video Modules		
	Frequency (MHz)	1x6	1x8	Frequency (MHz)	1x6	1x8
Insertion Loss (dB)	5 – 50	9.2	10.3	5 – 47	11.5	12.5
	50 – 500	9.8	10.6	47 – 1000	12.5	13.5
	500 – 750	10.5	11.5	1000 – 2050	16.5	17.5
	750 – 1000	11.0	12.5	2050 – 2300	17.5	18.5
	–	–	–	2300 – 2450	18.5	19.5
Return Loss (dB) (IN/OUT)	5 – 50	16.0	18.0	5 – 47	10.0/8.0	10.0/9.0
	50 – 500	20.0	18.0	47 – 1000	10.0/10.0	10.0/10.0
	500 – 750	20.0	20.0	1000-2450	10.0/10.0	10.0/10.0
	750 – 1000	18.0	18.0	–	–	–
	–	–	–	–	–	–
Isolation (dB)	5 – 50	25.0	25.0	5 – 47	20.0	20.0
	50 – 500	25.0	25.0	47 – 1000	20.0	20.0
	500 – 750	23.0	23.0	1000 – 2300	20.0	20.0
	750 – 1000	20.0	20.0	2300 – 2450	20.0	20.0
	–	–	–	–	–	–
Connector Type	–	“F” Female	“F” Female	–	“F” Female	“F” Female
Impedance (Ohms)	–	75	75	–	75	75
DC Pass	–	All Ports	All Ports	–	All Ports	All Ports
RFI (dB)	–	>130	>130	–	>130	>130

Active Video Modules



Product Facts

- Active video modules (AVMs) offer high performance, versatility and a “future-ready” solution for residential video distribution
- Amplifies the incoming CATV/ANT signal (provides 4 dB gain all eight outputs compared to an 11 dB loss (typical) a PVM)
- IR passing port to port
- Capable of reverse modulation utilizing a coax output port
- Modulator input is an amplifier circuit providing a 2 dB gain
- DC passing
- Features push-pin mounting (for mounting on equipment panels)

Description	Mounting Method	Inputs	Outputs	Frequency Range	Part Number
Active Video Modules	Push-Pin	2	8	1 GHz (5 – 1000 MHz)	1479337-1

Parameter	Frequency (MHz)	Minimum	Typical	Maximum
Gain – Cable In (dB)	100	2.5	4.0	–
	1000	3.0	4.0	–
Gain – Modulator 1	100	-1.0	2.0	–
	1000	-1.0	2.0	–
Loss – Reverse Band	5 – 40	–	-14.0	-17.0
Loss – OUT/OUT	54 – 1000	–	-14.0	-18.0
	54 – 100	–	-13.0	-11.0
Return Loss – Cable IN	100 – 750	–	-11.0	-9.0
	750 – 1000	–	-13.0	-11.0
	54 – 100	–	-12.0	-10.0
Return Loss – Modulator 1 IN (dB)	100 – 750	–	-12.0	-10.0
	750 – 1000	–	-12.0	-10.0
	54 – 1000	–	+/-2.0	–
Isolation – Cable OUT	54 – 1000	-75.0	-80.0	–
2nd Order Input Intercept (dB)	–	–	-75.0	–
3rd Order Input Intercept (dB)	–	–	-60.0	–
Composite 2nd Order (dB)	–	–	–	-60.0
Composite Triple Beat (dB)	–	–	-70.0	-60.0
Noise (dB)	54 – 60	–	3.8	5.5
	60 – 750	–	3.4	4.8
	750 – 1000	–	3.8	5.5
Hum Modulation (dB)	–	–	-70.0	–
RFI Isolation (dB)	5 – 1000	–	–	-130.0
DC Current (mA)	–	220.0	270.0	320.0
IR Pass	–	–	Out/Out	–

Video Distribution Accessories

Dual LNB Satellite/Coax Demarcation Module

PART NUMBER 1479338-1



Product Facts

- Provides a convenient means to distribute two satellite LNB inputs to any two outlet coax ports for digital satellite service
- Provides convenient demarcation for incoming coaxial cable

RCS 36 Video Patch Panel



A - Top



A - Front



B

Product Facts

- Provide a means to terminate all horizontal coax cables from wall outlets in one location without the need to purchase multiple video splitters/amplifiers
- Permanent horizontal coax cable is terminated once and no longer needs to be disturbed
- Reconfiguration is accomplished via mini-coax patch cables between the video patch panel and the video distribution modules
- Reduces cost and complexity of video distribution system – it's only necessary to purchase video splitters/amplifiers to support the number of ports actually used at any given time
- Reduces complexity of video distribution – The simpler the distribution system, the better
- Serves as a convenient means to patch incoming services (DSS, digital cable box input, cable modem input) directly to a selected wall outlet
- The combination of video patch panel and equipment panel provides greater aesthetics and flexibility for customizing a system
- Includes the following:
 - Six (6) Black Coax Patch Cables 1479008-1
 - Two (2) White Coax Patch Cables 1479009-1
 - One (1) 12-port Video Feed-Thru

Description	Figure	Part Number
RCS36 Video Patch Panel	A	1479283-1
12-Port Video Feed-Thru Expansion Module	B	1479286-1

Coax Patch Cables



A



B

Product Facts

- Flexible 75-ohm mini-coax patch cables provide convenient means for patching between video patch panel and video distribution modules
- Typical loss <1dB (from 5 – 1000MHz)

Description	Length	Figure	Part Number
RG59 Mini-Coax Patch Cable	Black	36"	A
		18"	A
	White	18"	B

A-BUS Audio System Components

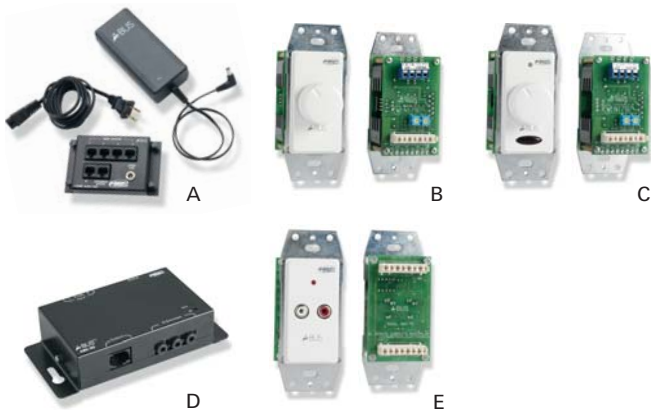

Description	Figure	Part Number
4-Port Hub Kit w/Power Supply	A	1479534-1
Amplified Volume Control	B	1479392-1
Amplified Volume Control w/IR	C	1479393-1
Source Input Module	D	1479395-1
Local Input Module	E	1479396-1

Product Facts

- Premium A-BUS Audio Distribution System:
 - Line-level audio, IR, and source on/off status is distributed from a central source (e.g., PC, TV, CD player, etc.) over Cat 5 or better cabling to amplified volume control modules located in each room – eliminating the need for a separate amplifier.
 - Any Cat 5e/6 outlet jack can be used for audio distribution by simply connecting the source input module using a standard Cat 5 patch cable, then making the appropriate connection in the Media Convergence Center (MCC). Speaker cable (16 AWG recommended) is only required between the volume control and speaker pair located in each room. Volume controls are available with or without IR capability.
- A-BUS Distribution Hubs support up to four zones. The number of zones can be expanded by adding additional hubs via the expansion port. Local input modules allow each audio zone to be used for independent listening. (See figure below.)

Typical 8-Ohm, 50Watt in-ceiling/wall speakers

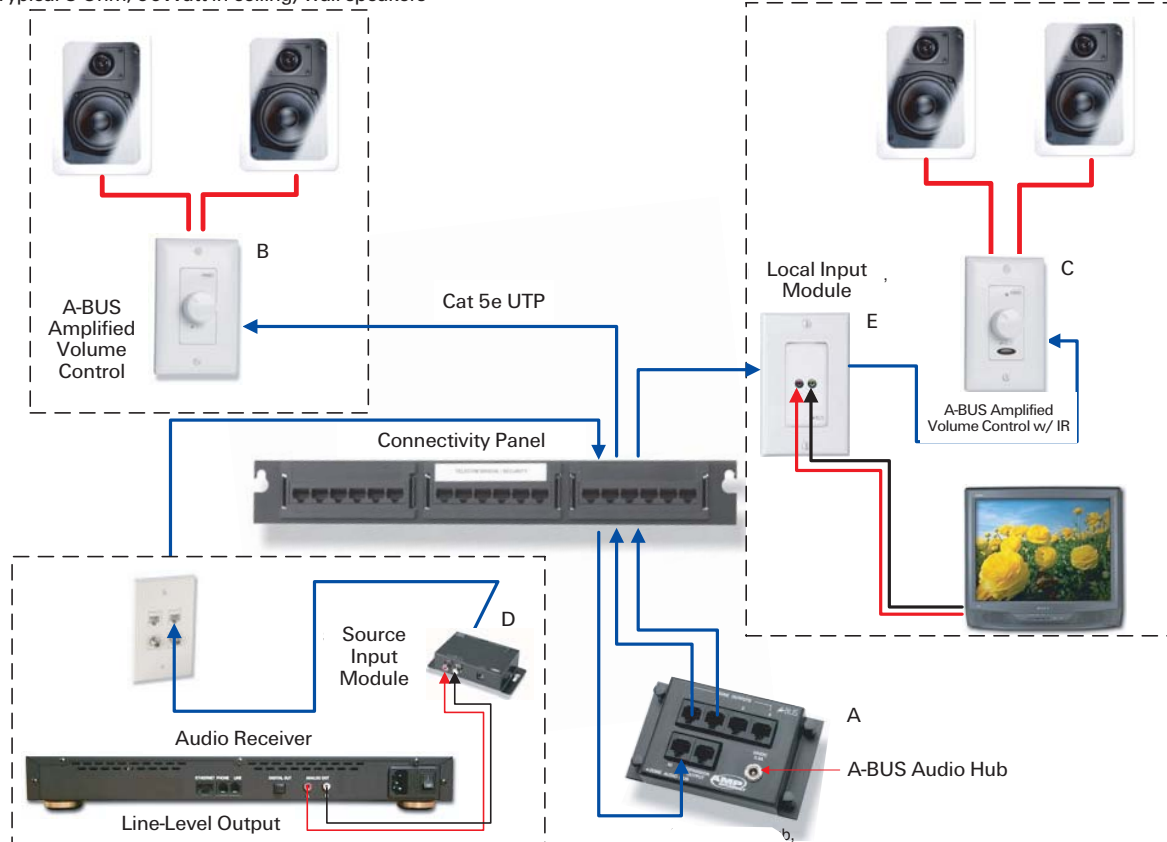

RCS Media Convergence Centers

RCS14 Media Convergence Center

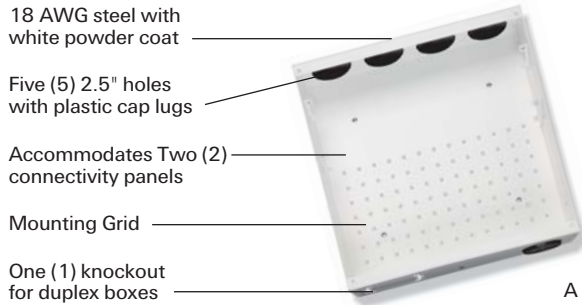

- 18 AWG steel with white powder coat
- Five (5) 2.5" holes with plastic cap lugs
- Accommodates Two (2) connectivity panels
- Mounting Grid
- One (1) knockout for duplex boxes

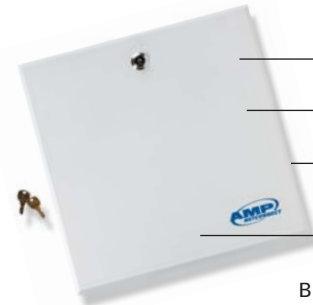

- 20 AWG steel
- White powder coat
- Beveled edge for safety & aesthetics
- Clear adhesive sleeve for documentation (inside cover)

*One (1) duplex electrical box included

Description	Figure	Dimension	Part Number
RCS 14 Enclosure	A	14.25" H x 14.25" W x 3.6" D	1479952-1
RCS 14 Screw-on Cover	-	-	1479014-1
RCS 14 Lockable Cover	B	-	1479715-1

RCS28 Media Convergence Center

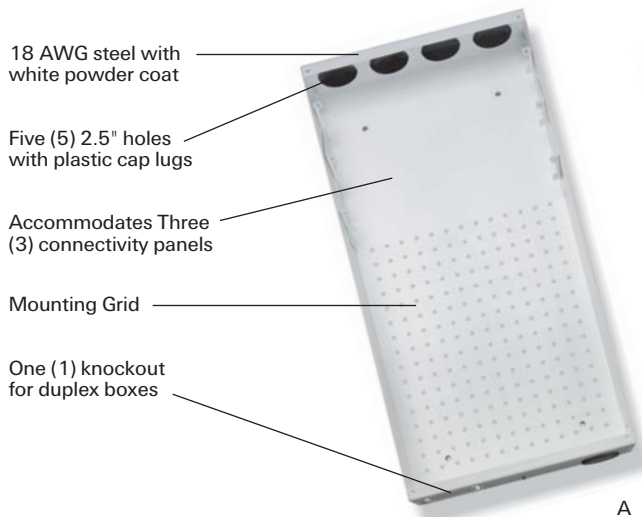

- 18 AWG steel with white powder coat
- Five (5) 2.5" holes with plastic cap lugs
- Accommodates Three (3) connectivity panels
- Mounting Grid
- One (1) knockout for duplex boxes



- 20 AWG steel
- White powder coat
- Beveled edge for safety & aesthetics
- Clear adhesive sleeve for documentation (inside cover)

*One (1) duplex electrical box included

Description	Figure	Dimension	Part Number
RCS28 Enclosure	A	28.0" H x 14.25" W x 3.6" D	1479953-1
RCS28 Screw-on Cover	-	-	1479954-1
RCS28 Lockable Cover	B	-	1479955-1

RCS36 Media Convergence Center

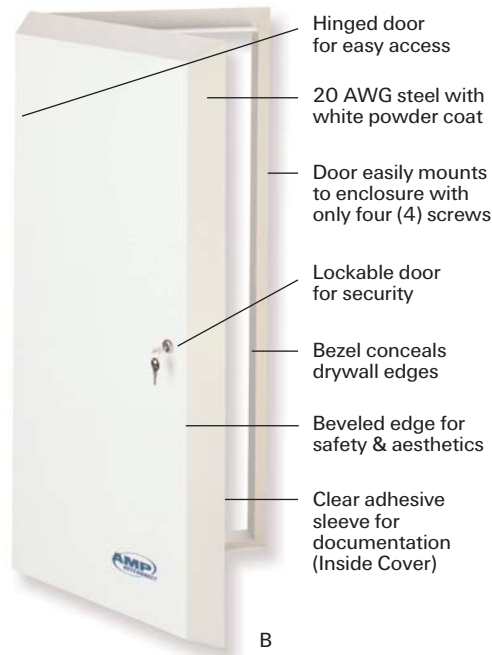
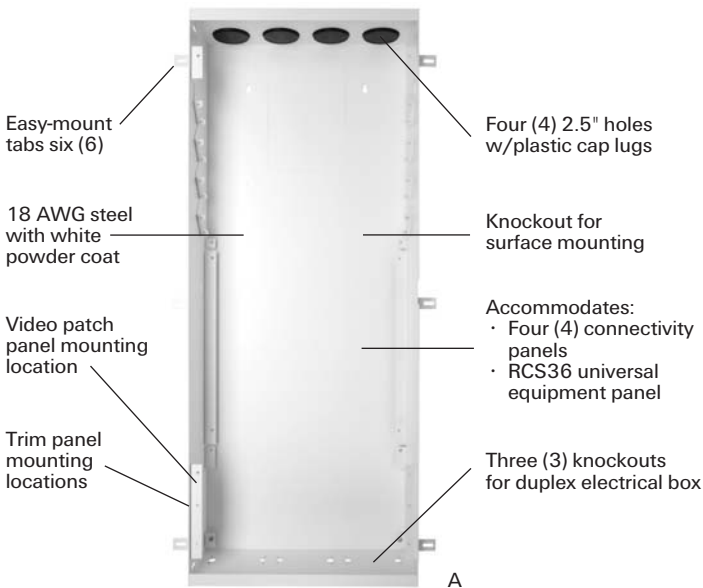

*One (1) duplex electrical box included

Description	Figure	Dimension	Part Number
RCS36 Enclosure	A	36" H x 14.25" W x 6" D	1375216-1
RCS36 Door	B	-	1375272-1

*RCS36 recommended for maximum flexibility and expandability.

RCS MCC Accessories and Security Panels

Media Convergence Center Accessories

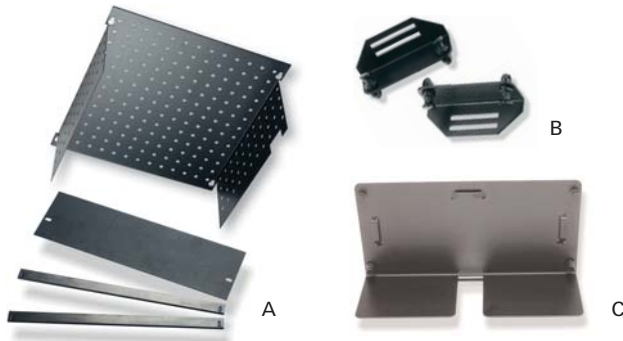

Description	Figure	Part Number
RCS36 Universal Equipment Panel	A	1479282-1
VELCRO Hold-Down Bracket	B	1479440-1
Network Shelf	C	1479437-1

Product Facts

- Universal Equipment Panel (for use with RCS36 only):
 - 1" x 1" grid pattern accepts audio, video and accessory modules with plastic push-pin fasteners
 - Creates raceway for cable concealment and enhanced aesthetics
- Equipment Mounting Shelf:
 - Accommodates network electronics such as Cable/DSL modems, routers, and switches (Recommended for RCS28 and RCS36)
- VELCRO Hold-Down Bracket:
 - Used to secure network electronics, such as Cable/DSL routers

VELCRO Cable Ties



Description	Figure	Part Number
1" x 8"	A	1375253-X
1" x 12"	A	1375254-X
5/8" x 5 yards	B	1375255-X

X denotes color: -2 = Black, -3 = White, -4 = Gray, -5 = Orange, -6 = Blue, -7 = Red, -8 = Yellow, -9 = Green, 1-0 = Violet

Product Facts

- For 8" and 12" ties, an order quantity of one equals one roll of ten (10) ties

Security Panel Mounting Accessories

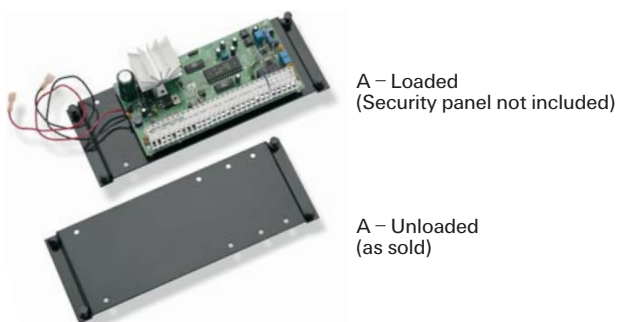

Description	Figure	Part Number
DSC Security Mounting Bracket	A	1479518-1
RCS36 Security Mounting Panel	-	1479540-1

Product Facts

- DSC Security Mounting Bracket:
 - Mounts on RCS36 universal equipment panel and directly to the back of the RCS14 and RCS28
 - Accommodates the following DSC security modules: PC580HS, PC1555HS, PC5010HS, PC5020HS, PC5204, PC5580TC
- RCS36 Security Mounting Panel:
 - Mounts in top or bottom of RCS36 enclosure in place of cover plate included with RCS36 equipment panel and video patch panel
 - Accommodates same DSC security modules as the DSC security mounting bracket above

AMP NETCONNECT CABLING SYSTEMS

Twisted Pair Systems	294
Shielded XG (10 Gb/s)	295
Unshielded	297
AMP Communications Outlet (ACO)	299
Optical Fiber Systems	300
MT-RJ SECURE Segregated Networks Products	301
Centralized Fiber Network with LC Connectors	303
SAN and Data Center Systems	304
MRJ21 High Density Copper Cabling	305
MPO High Density Optical Fiber Cabling	307
Telecommunications Enclosures ("Tiny TR")	308
Power over Ethernet (PoE) over Twisted Pair Cabling	310
Open Office Systems	312
Consolidation Point	313
Multi-User Outlet (MUO)	315
Centralized Network Administration (CNA) Systems	316
Wireless Systems	318

Chapter Summary

- Example systems are shown with illustrations, part numbers and informational text
- Most examples list only one product set (ex: Category 6 CMP cabling), but most can be constructed with other system components as well - examples are not intended to be exclusionary
- Examples shown are for illustrative purposes and are not necessarily recommendations - industry standards and other applicable documents and regulations should be consulted before settling on a specific design
- For more information or questions on AMP NETCONNECT products, contact Tyco Electronics

12



12

293

Twisted Pair Systems

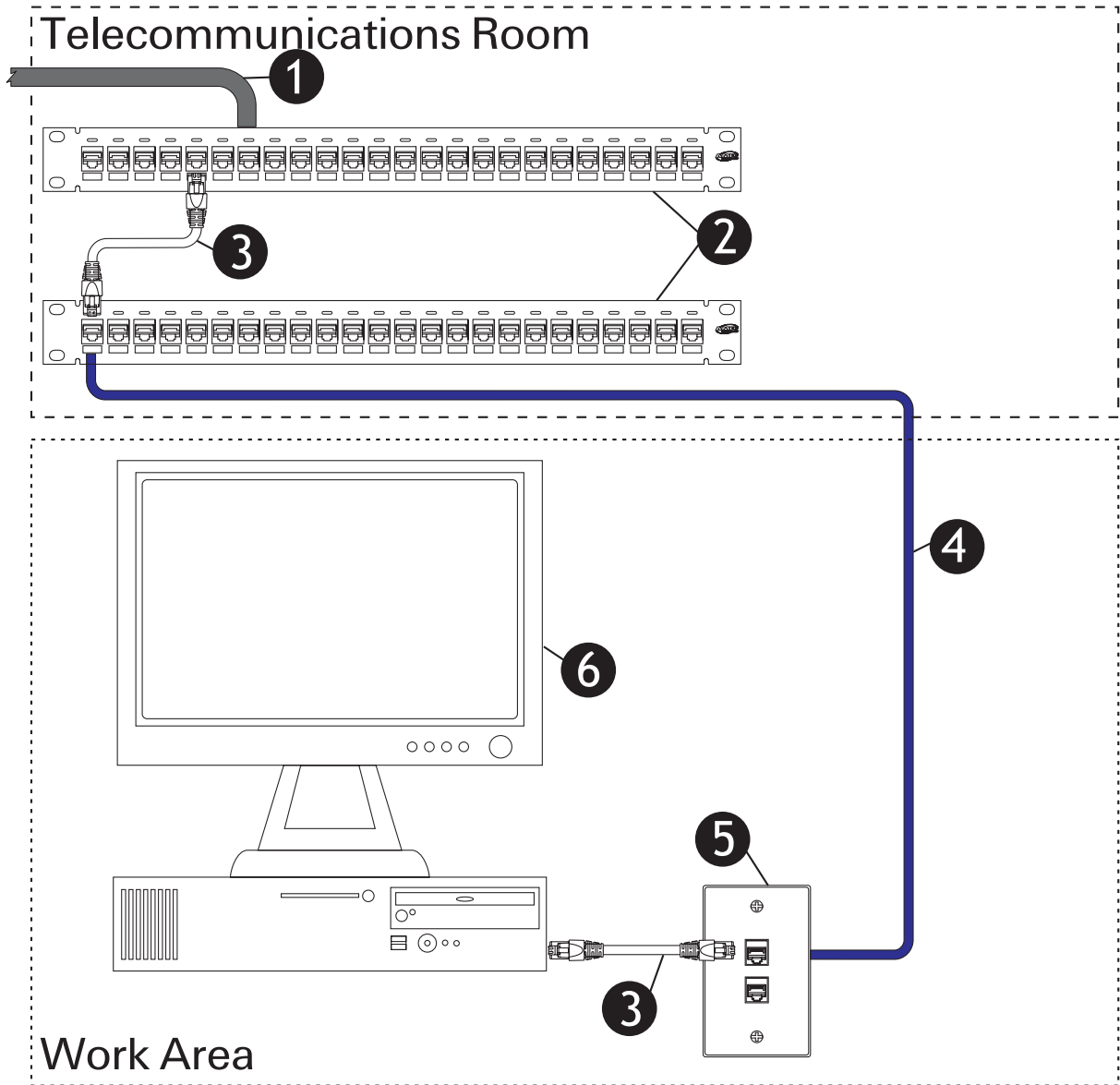

Shielded X6 Category 6A (10 Gb/s)

The AMP NETCONNECT Shielded Product Solution offers higher electrical performance and virtually eliminates ANEXT associated with 10 Gig transmission. The system meets all TIA/EIA Category 6A performance standards and IEEE 802.3an, 10 Gigabit Ethernet requirements.

The AMP NETCONNECT XG Category 6A Copper Cabling Solution overcomes the ANEXT problem and will support 10GBASE-T to 100 m. Our cable and connecting hardware designs minimize the adverse effects of ANEXT, resulting in a high signal-to-noise ratio. The AMP NETCONNECT XG Copper System offers the transmission capacity needed for 10GBASE-T. Intensive lab tests, applying worst case configurations in conjunction with testing up to 625 MHz, and the extensive proven experience in the field have demonstrated these superior cable, connector, and patch panel designs which fully support the proposed 10G data rates.

- Supports 10GBASE-T on 100 m and shorter channels
- Proven Shannon Capacity > 18 GBit/s
- Tested up to 625 MHz
- Excellent ANEXT suppression
- Easy installation
- Available in SL Series Jack style

Shielded XG (10 Gb/s)

Item	Part Number	Quantity	Page
1) Twisted Pair Cables			3-11
Category 6A F/UTP Cable, CMR	1499389-X		5
Category 6A F/UTP Cable, CMP	1499416-X		5
2) Twisted Pair Patch Panels			33-50
XG Category 6A Shielded Patch Panel, 24-Port, with AMP-TWIST Jacks	1933319-2		34
XG Category 6A AMPTRAC Shielded Patch Panel, 24-Port, with AMP-TWIST Jacks	1933331-1		233
3) Twisted Pair Cable Assemblies			27-32
Category 6 Shielded Patch Cable Assembly, White	1499480-X		28
4) Twisted Pair Cables			3-11
Category 6A F/UTP Cable, CMR	1499389-X		5
Category 6A F/UTP Cable, CMP	1499416-X		5
5) Outlets, Faceplates and Accessories – Connectors, Couplers and Adapters			
Flush Faceplate, 2-Port	1479444-X		155
SL Series AMP-TWIST-6S Modular Jack	1711342-1		13
6) Computer Equipment			
SL Series Modular Jack Termination Tool	1725150-3		67

Twisted Pair Systems

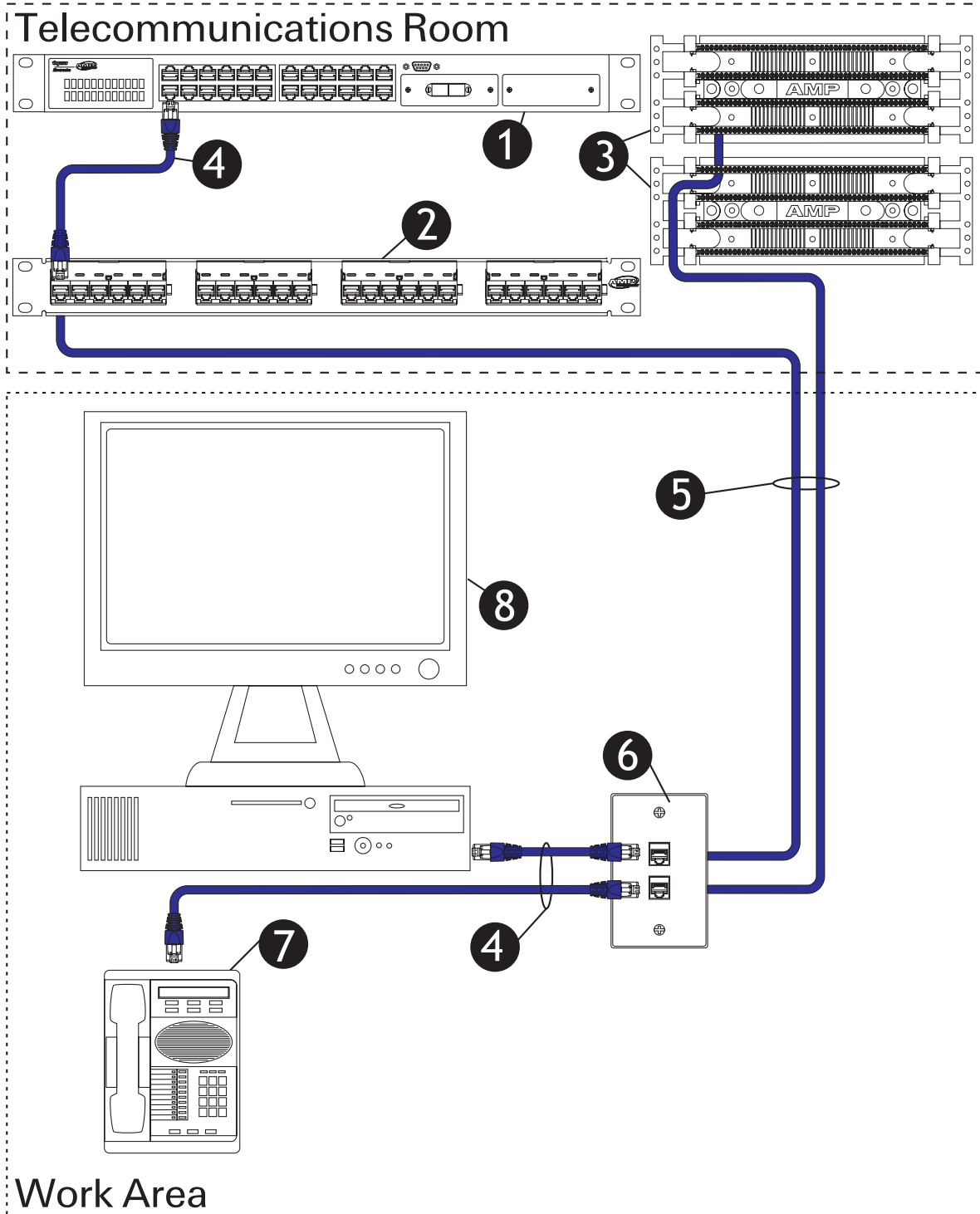

Unshielded

AMP NETCONNECT SL Series products combine the easy termination of the 110-style punchdown block with the proven performance characteristics of AMP NETCONNECT modular jacks. SL Series products offer a complete, cost-effective means to cable a building for unshielded and shielded twisted pair, optical fiber and coaxial applications. A wide variety of work area outlet solutions is available supporting twisted pair, optical fiber and coaxial applications. Outlets include multiple styles of wall mount faceplates, decorator and duplex mounting straps, FLEX-MODE faceplates for modular furniture applications, Office Box surface mount outlets, and the Access Floor Workstation Module (AFWM) products.

The SL Series System has the advantage of high port densities at the outlet due to a smaller modular jack form factor and adds the advantages of single port replacement to the patch panel. This also allows individual termination of each patch panel port with the SL Series Termination Tool, speeding installation. SL Series Discrete Patch Panels allow custom, mix-and-match-style multimedia configurations.

Unshielded

Item	Part Number	Quantity	Page
1) LAN Electronics			243-252
SNMP Managed Ethernet Switch	1591099-X		248
2) Twisted Pair Patch Panels			33-50
Category 6 SL Series 24-Port Patch Panels	1375014-X		35
Category 6 SL Series 48-Port Patch Panels	1375015-X		35
Category 5e SL Series 24-Port Patch Panels	1479154-X		36
Category 5e SL Series 48-Port Patch Panels	1479155-X		36
3) Twisted Pair Cross-Connects			51-60
610XC Category 6 Cross-Connect, 100-Pair Kit	1479254-1		53
110Connect XC Category 5e Cross-Connect, 100-Pair Kit	569439-1		57
4) Twisted Pair Cable Assemblies			27-32
Category 6 Patch Cable Assemblies	219884-X		28
Category 5e Patch Cable Assemblies	406483-X		29
5) Twisted Pair Cables			3-11
Category 6, CMR	219560-X		5
Category 6, CMP	219567-X		5
Category 6E, CMR	1499038-X		6
Category 6E, CMP	1499033-X		6
Category 5e, CMR	219538-X		7
Category 5e, CMP	219513-X		7
Category 5E, CMR	57826-X		8
Category 5E, CMP	57825-X		8
6) Outlets, Faceplates and Accessories – Connectors, Couplers and Adapters			
Flush Faceplate, 2-Port	1479444-X		155
Category 6 SL Series Modular Jack	1375055-X		13
Category 5E SL Series Modular Jack	1375191-X		14
7) Multi-line Telephone			
8) Computer Equipment			
SL Series Modular Jack Termination Tool	1725150-1		67

Twisted Pair Systems

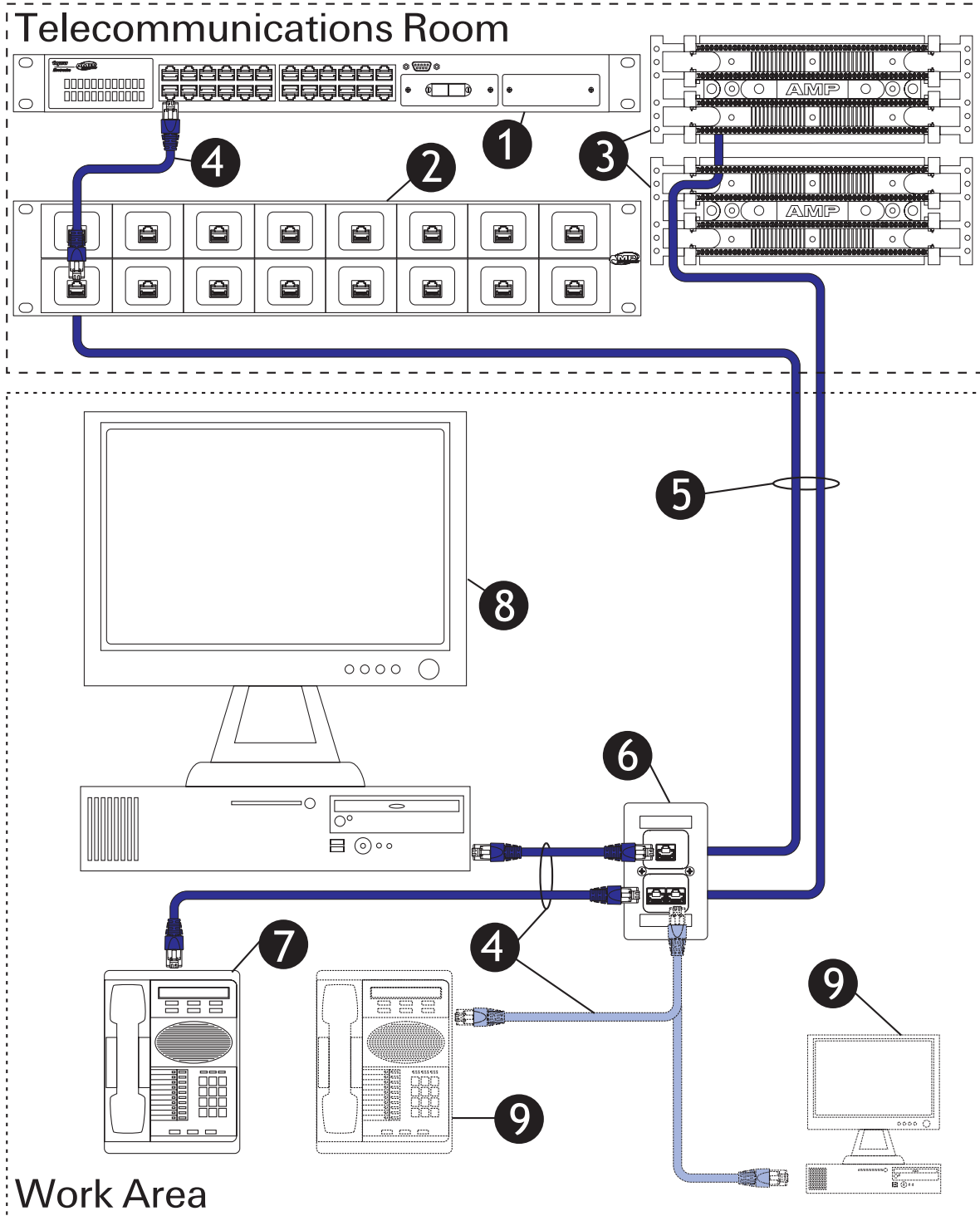

AMP Communications Outlet (ACO)

The AMP Communications Outlet (ACO) is a unique flexible cabling system that provides two significant advantages over traditional “hard-wired” modular jacks. The first is the ability to change the connector interface at the work area outlet and at the patch panel without having to re-terminate the horizontal distribution cable. This allows the cabling system to adapt to changing equipment requirements without the need to re-certify the performance of the system. The “standard” alternative to this is to make or purchase custom, possibly long lead-time, cable assemblies to adapt an 8-position jack to suit your equipment. The second advantage offered by the ACO System is the easy ability to combine two applications in the same 4-pair cable. Since most communications applications require only one or two pairs to operate, half of a standard hard-wired cable plant is typically wasted. AMP Communications Outlet dual-jack inserts allow an outlet to be changed from two 100BASE-T stations to two ATM stations in minutes, again without the need to re-terminate or re-certify the cable.

AMP Communications Outlet (ACO)

Item	Part Number	Quantity	Page
1) LAN Electronics			243-252
SNMP Managed Ethernet Switch	1591099-X		248
2) Twisted Pair Patch Panels			33-50
Category 6, ACO Single-Port Patch Panel Kit, 16-Port, Unshielded	1479311-1		43
Standard, ACO Single-Port Patch Panel Kit, 16-Port, Unshielded	406363-1		44
3) Twisted Pair Cross-Connects			51-60
610XC Category 6 Cross-Connect, 100-Pair Kit	1479254-1		53
110Connect XC Category 5e Cross-Connect, 100-Pair Kit	569439-1		57
4) Twisted Pair Patch Cable Assemblies			27-32
Category 6 Patch Cable Assemblies	219884-X		28
Category 5e Patch Cable Assemblies	406483-X		29
5) Twisted Pair Cables			3-11
Category 6, CMR	219560-X		5
Category 6, CMP	219567-X		5
Category 6E, CMR	1499038-X		6
Category 6E, CMP	1499033-X		6
Category 5e, CMR	219538-X		7
Category 5e, CMP	219513-X		7
Category 5E CMR	57826-X		8
Category 5E, CMP	57825-X		8
6) Outlets, Faceplates and Accessories			149-200
ACO Faceplate, Single Gang	558510-X		80
Category 6, ACO Dual-Port Installation Kit, Unshielded	1479306-1		172
Standard, ACO Dual-Port Installation Kit, Unshielded	406352-1		172
Category 6, ACO Single Insert, T568A Wiring, Unshielded/Shielded	1644031-X		178
Category 6, ACO Single Insert, T568B Wiring, Unshielded/Shielded	1644027-X		178
Standard, ACO Single Insert, T568A Wiring, Unshielded	558908-X		178
Standard, ACO Single Insert, T568B Wiring, Unshielded	558909-X		178
Standard, ACO Dual Insert, 10/100BASE-T Wiring, Unshielded	557280-X		179
7) Multi-line Telephone			
8) Computer Equipment			
9) Extra Multi-line Telephone or Computer Equipment, application depends upon insert chosen			

Optical Fiber Systems

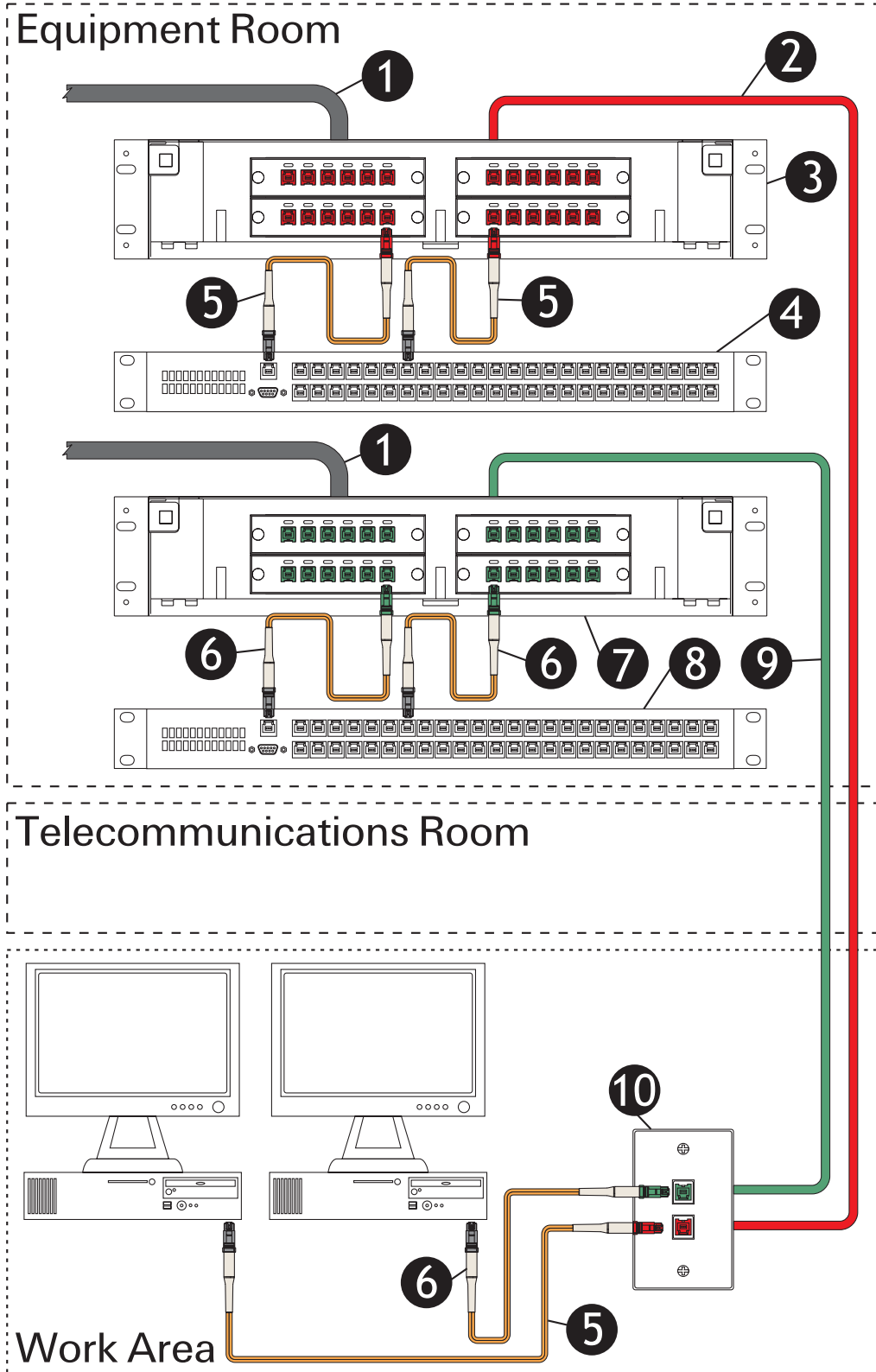

12

300

MT-RJ SECURE Segregated Networks

The MT-RJ SECURE connector system is designed to provide additional security and segregation for installations running multiple networks in common spaces. Although initially installed in government and defense locations as a means to prevent cross-connection between networks of different classifications, these products have proven themselves in other applications such as financial institutions, research laboratories and college campus networks.

Each color version of the MT-RJ SECURE jacks and plugs has a different slot and key combination that prevents plug to jack mating unless the plug color and jack color match. With a complete line of jacks, cables and cable assemblies, the MT-RJ SECURE system allows access to multiple networks from the same location without concern of inadvertent cross-connection or improper network access.

In this system, two of the ten color versions are used - green and red. The green switch connects via a green MT-RJ SECURE plug and jack to the "Green Network" cabling, which is also terminated in a green MT-RJ SECURE jack. A green MT-RJ SECURE cable assembly completes the connection to the work area equipment. A similar network is run in parallel as a "Red Network". Although only red and green are shown, similar networks can be constructed with up to eleven variations - ten colored version and the standard MT-RJ.

This example shows the MT-RJ SECURE System installed in a centralized fiber network. Here, the MT-RJ SECURE jacks are installed on both ends of the plenum-rated pull-through cable, and MT-RJ SECURE patch cords are used to connect to the equipment in the equipment room and work area. With this network, you can have access to both networks in the same faceplate. Note that the standard MT-RJ snap-in adapter plates work with the MT-RJ SECURE Jacks.

MT-RJ SECURE Segregated Networks

Item	Part Number	Quantity	Page
1) Optical Fiber Backbone Cabling			
Distribution Cable, 24-Fiber, 62.5/125 µm Multimode, OFNR	1-1664058-1	_____	78
2) Optical Fiber Pull-through Cable - RED Network			
DUAL Cable, 2-Fiber, 62.5/125 µm Multimode, OFNP - RED	1-1664029-4	_____	86
3) Optical Fiber Rack Mount Enclosure and Adapter Plates - RED Network			
2U Rack Mount Enclosure for Standard Optical Fiber Cables	.559542-2	_____	125
MT-RJ Jack Snap-in Adapter Plate	1278328-3	_____	120
MT-RJ SECURE Patch Panel Jacks, 62.5/125µm, RED	.6588878-1	_____	203
4) Optical Fiber LAN Equipment with MT-RJ Interface			
5) Optical Fiber Cable Assemblies - RED Network			
MT-RJ SECURE Patch Cord, RED, 62.5/125 µm Multimode, 1 meter	.6278890-1	_____	204
6) Optical Fiber Cable Assemblies - GREEN Network			
MT-RJ SECURE Patch Cord, GREEN, 62.5/125 µm Multimode, 1 meter	.6278892-1	_____	204
7) Optical Fiber Rack Mount Enclosure and Adapter Plates - GREEN Network			
2U Rack Mount Enclosure for Standard Optical Fiber Cables	.559542-2	_____	125
MT-RJ Jack Snap-in Adapter Plate	1278328-3	_____	120
MT-RJ SECURE Patch Panel Jacks, 62.5/125µm, GREEN	.6588878-3	_____	203
8) Optical Fiber LAN Equipment with MT-RJ Interface			
9) Optical Fiber Pull-through Cable - GREEN Network			
DUAL Cable, 2-Fiber, 62.5/125 µm Multimode, OFNP - GREEN	1-1664029-2	_____	86
10) Outlets, Faceplates and Accessories – Connectors, Couplers and Adapters			
Flush Faceplate, 2-Port	1479444-X	_____	155
MT-RJ SECURE Outlet Jacks, 62.5/125 µm, RED	.6278810-1	_____	202
MT-RJ SECURE Outlet Jacks, 62.5/125 µm, GREEN	.6278810-3	_____	202

Optical Fiber Systems

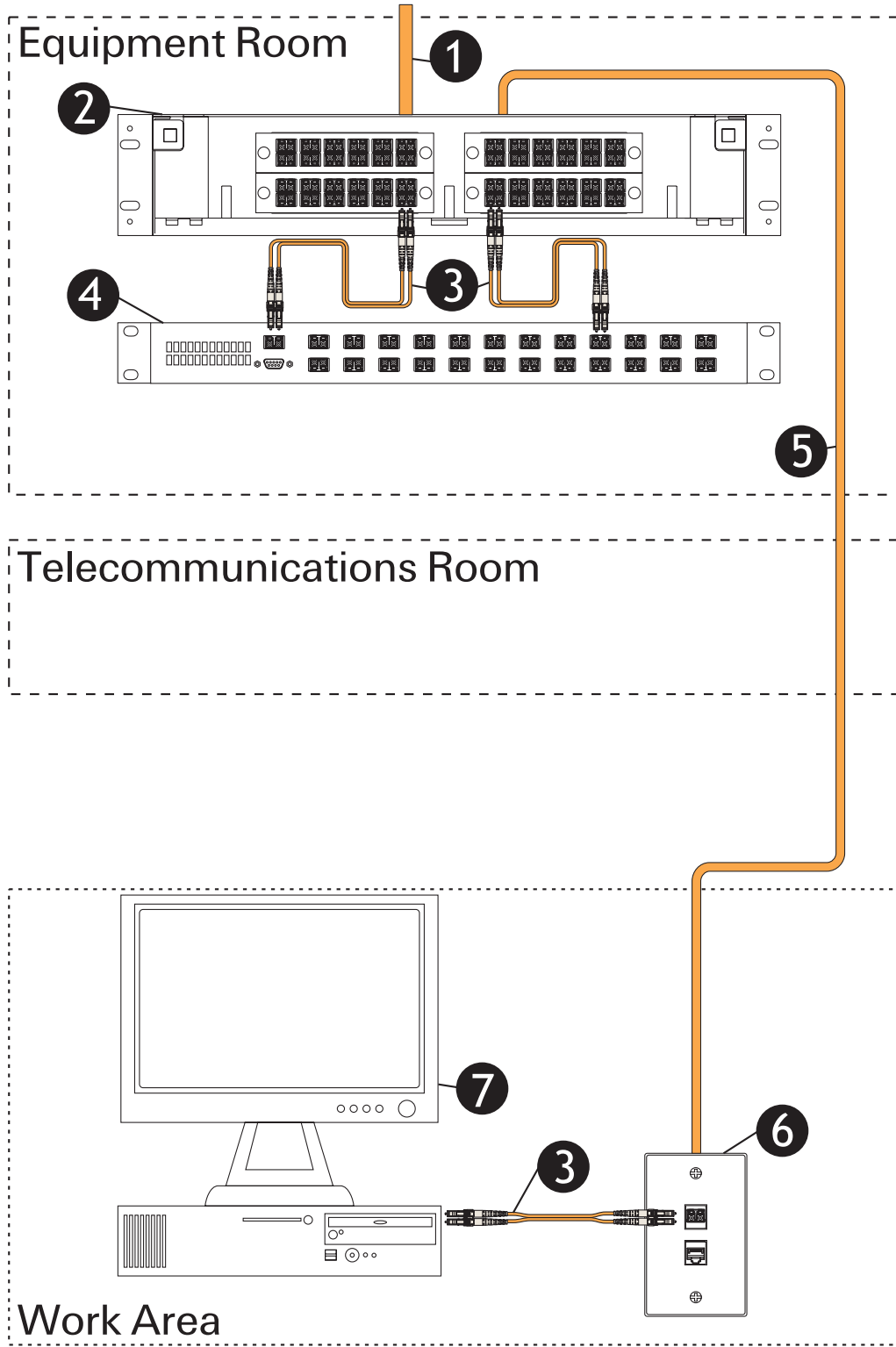

Centralized Fiber Network with LC Connectors

The LC small form factor connector has become increasingly popular in single-mode systems and as an electronics interface. It's design is similar to the SC connector, only smaller. Small enough, in fact, that an LC duplex connector is only slightly larger than a simplex SC. Tyco Electronics offers AMP NETCONNECT LC connectors in the popular LightCrimp Plus (no-epoxy/no-polish) and epoxy/polish product lines.

In this example, a Centralized Fiber Network is constructed using LAN equipment with an LC duplex interface, LC duplex patch cords, plenum fiber cable and LC LightCrimp Plus connectors. Note that the pull-through fiber cable (5) is routed through the Telecommunications Room without termination. This is allowed by the TIA-568B Standard as long as the pull-through cable length does not exceed 90 meters.

Centralized Fiber Network with LC Connectors

Item	Part Number	Quantity	Page
1) Optical Fiber Backbone Cable			
Distribution Cable, 24-Fiber, 50/125 μm Multimode, OFNR	2-1664056-1		78
2) Optical Fiber Rack Mount Enclosure and Adapter Plates			
2U Rack Mount Enclosure for Standard Optical Fiber Cables	559542-2		125
LC Snap-in Adapter Plate, Multimode, 24-Fiber	1435516-2		120
LC Simplex LightCrimp PLUS, 50/125 μm Multimode Connectors	6754483-2		95
3) Optical Fiber Cable Assemblies			103-112
LC Patch Cable Assembly, 50/125 μm	1906866-1		109
4) Optical Fiber LAN Equipment with LC Interface			
5) Optical Fiber Pull-through Cable			
Horizontal Cable, 2-Fiber (Dual), 50/125 μm Multimode, OFNP	2-1664027-1		86
6) Outlets, Faceplates and Accessories – Connectors, Couplers and Adapters			
Flush Faceplate, 2-Port	1479444-X		155
SL Series Insert, LC Duplex, Multimode	1435735-X		101
LC Simplex LightCrimp PLUS, 50/125 μm Multimode Connectors	6754483-1		95
7) Computer Equipment			

SAN and Data Center Systems

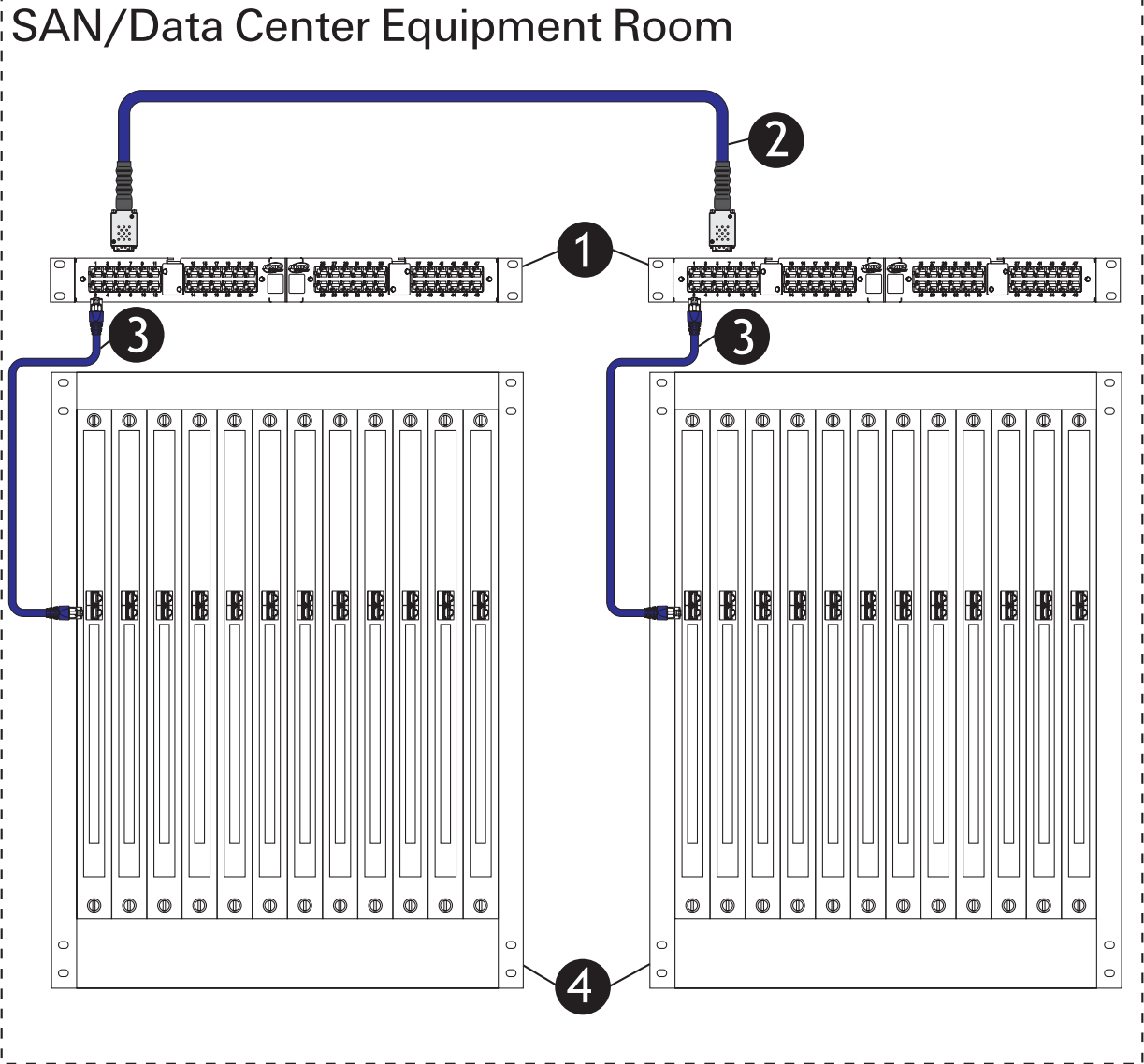

MRJ21 High Density Copper Cabling

The MRJ21 Connector System Solution is a high-density, high-performance, modular copper cabling system. Our matched powersum 24-pair cabling and connector solution provides a variety of applications to up to 12 ports with a single cable. This solution supports any plug and play environment including data centers and zone cabled or open office environments. When utilizing our PC board mounted solution, the MRJ21 connector enables much higher switch port density than the common Modular plug/jack interface, which can reduce active port costs.

- MRJ21 connector system provides an application independent copper platform for applications today and into the future – including Gigabit, VoIP & powered Ethernet
- The small size of the MRJ21 connector and cabling reduces cable bulk in pathways and spaces, enabling much higher manageable port counts in a smaller space
- Factory termination and testing of the cassettes and patch panels allow pluggable performance on site. This enables rapid installation or MACs with pre-tested quality
- The modularity of this solution significantly reduces time to install or migrate from a 10/100BASE-T 2-pair platform to a Gigabit Ethernet 4-pair platform. Upgrading is as simple as unplugging one cassette and plugging in the new one. The same cable is re-usable. A 48-port 1U panel can be installed with Gigabit performance in minutes compared to a traditional 48 port discrete RJ45 panel which can take hours to install.
- Cassettes and patch panels break out high-performance 24-pair solutions to the appropriate wiring patterns for standards based 10/100BASE-T, Gigabit Ethernet, and other applications
- Common cable assembly lengths provide readily available, pluggable solutions, speeding implementation
- Additional hardware options continue to be released. Contact your sales engineer or check our website for the latest updates

MRJ21 High Density Copper Cabling

Item	Part Number	Quantity	Page
1) Twisted Pair Data Center/SAN Products			.61-64
MRJ21 Patch Panel, Angled, 48-Port	1777052-1	_____	.63
2) Twisted Pair Data Center/SAN Products			.61-64
MRJ21 Cable Assembly, 180° Back Shells, CMR	1499515-X	_____	.64
MRJ21 Cable Assembly, 180° Back Shells, CMP	1499518-X	_____	.64
3) Twisted Pair Patch Cable Assemblies			.27-32
Category 6 Patch Cable Assemblies	.219884-X	_____	.28
Category 5e Patch Cable Assemblies	.406483-X	_____	.29
4) Rack Mounted Server			

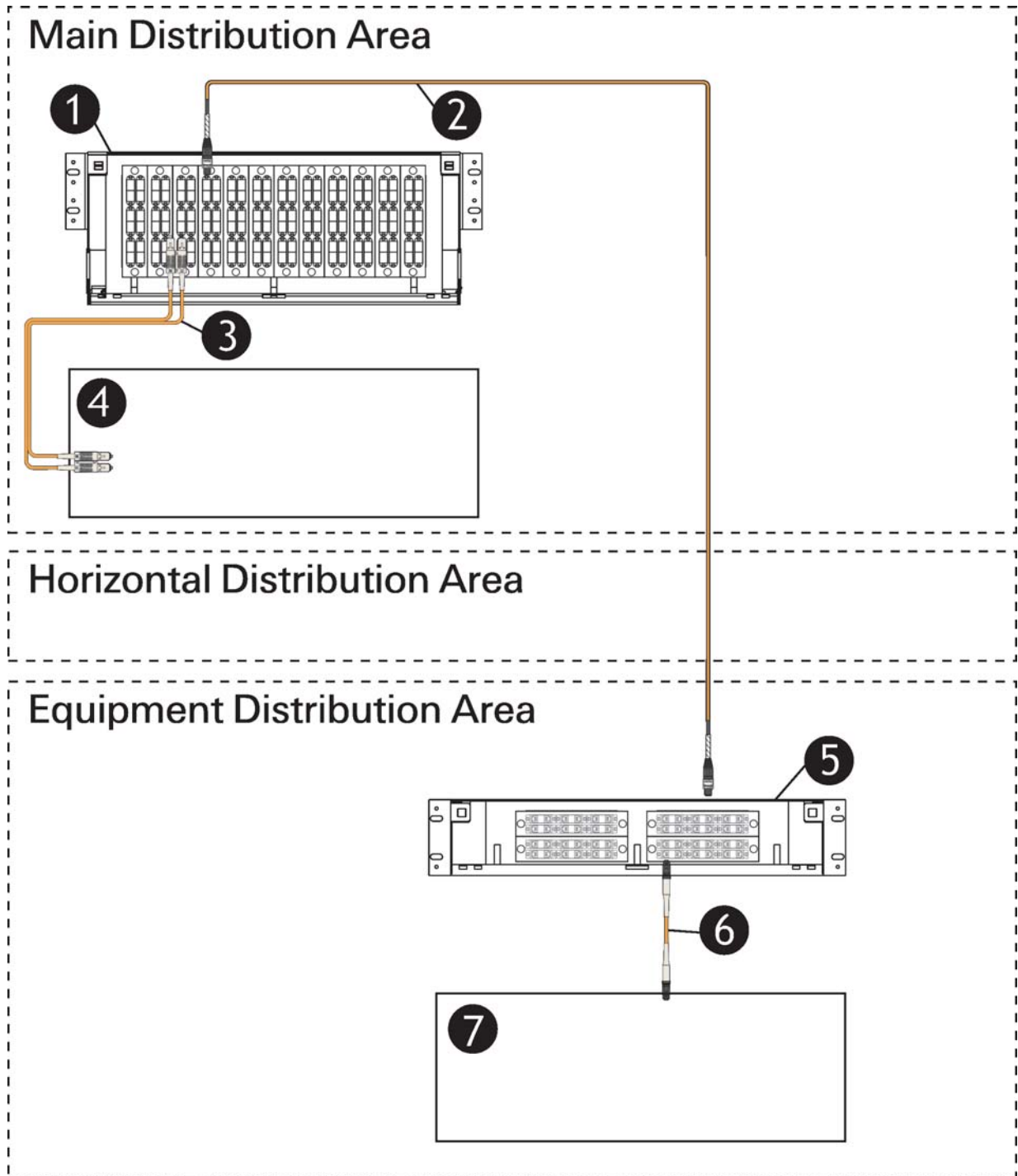

MPO High Density Optical Fiber Cabling

Data Centers (DCs) and Storage Area Networks (SANs) have slightly different conditions than traditional commercial building cabling networks. Unlike the TIA-568B commercial building networks, which are distributed networks, the DC/SAN networks are concentrated networks with a premium placed on reliability, density and speed of installation.

Just as the MRJ21 connector system for copper offers a twisted pair solution, the MPO products offer a solution for optical fiber networks. These products are based on the high-density, 12-fiber MPO array connector. In the MPO ferrule, 12 fibers are terminated in a connector the same size as a single-fiber SC connector. Thus, the MPO solutions offer the highest density solution with the added advantages of optical fiber - high data rates, small diameter flexible cables, and resists electromagnetic and radio frequency interference.

Trunk cables are terminated with MPO connectors. Cassettes offer a modular breakout of the fibers in the MPO connector to more common interfaces such as MT-RJ, SC duplex and LC. Together, constructing a functional link between equipment can be accomplished rapidly, simply and without the complexity of a normal move, add or change.

In this example, the Main Distribution Area (MDA) is connected to remote equipment in the Equipment Distribution Area (EDA) by a link constructed of common patch cords, a trunk cable, and cassettes in a centralized fiber network. Since the TIA-942 Standard allows up to 300 m for optical fiber pull-through cables, and because data centers thrive on high data rates, this example is constructed with XG (850 nm LO 50/125 μm) optical fiber to allow 10 Gb/s data rates to the full 300 m distance. These components can be constructed in many ways to make viable links between equipment, and the interfaces can be mixed and matched on either end of the trunk cable cassettes to match the equipment interfaces. In this example, a SC duplex interfaces are used in the MDA and MT-RJ interface equipment is used in the EDA.

MPO High Density Optical Fiber Cabling

Item	Part Number	Quantity	Page
1) Rack Mount Enclosure and Cassettes			
4U Rack Mount Enclosure for Armored and Trunk Cables	1435558-1	_____	126
MPO Cassette, SC Duplex, 12-Fiber, XG (850 nm LO 50/125 μm) MM	6754333-2	_____	117
2) MPO Trunk Cable Assembly, 24-Fiber, XG (850 nm LO 50/125 μm) MM, CMR	1754687-X	_____	116
3) SC Duplex Patch Cable Assembly, XG (850 nm LO 50/125 μm) MM	6828151-X	_____	108
4) DC/SAN Director			
5) Rack Mount Enclosure and Cassettes			
2U Rack Mount Enclosure for Armored and Trunk Cables	1435556-1	_____	125
MPO Cassette, MT-RJ, 24-Fiber, XG (850 nm LO 50/125 μm) MM	1918778-1	_____	117
6) MT-RJ Patch Cable Assembly, XG (850 nm LO 50/125 μm) MM	6588572-X	_____	106
7) Storage Device			

Telecommunications Enclosures ("Tiny TR")

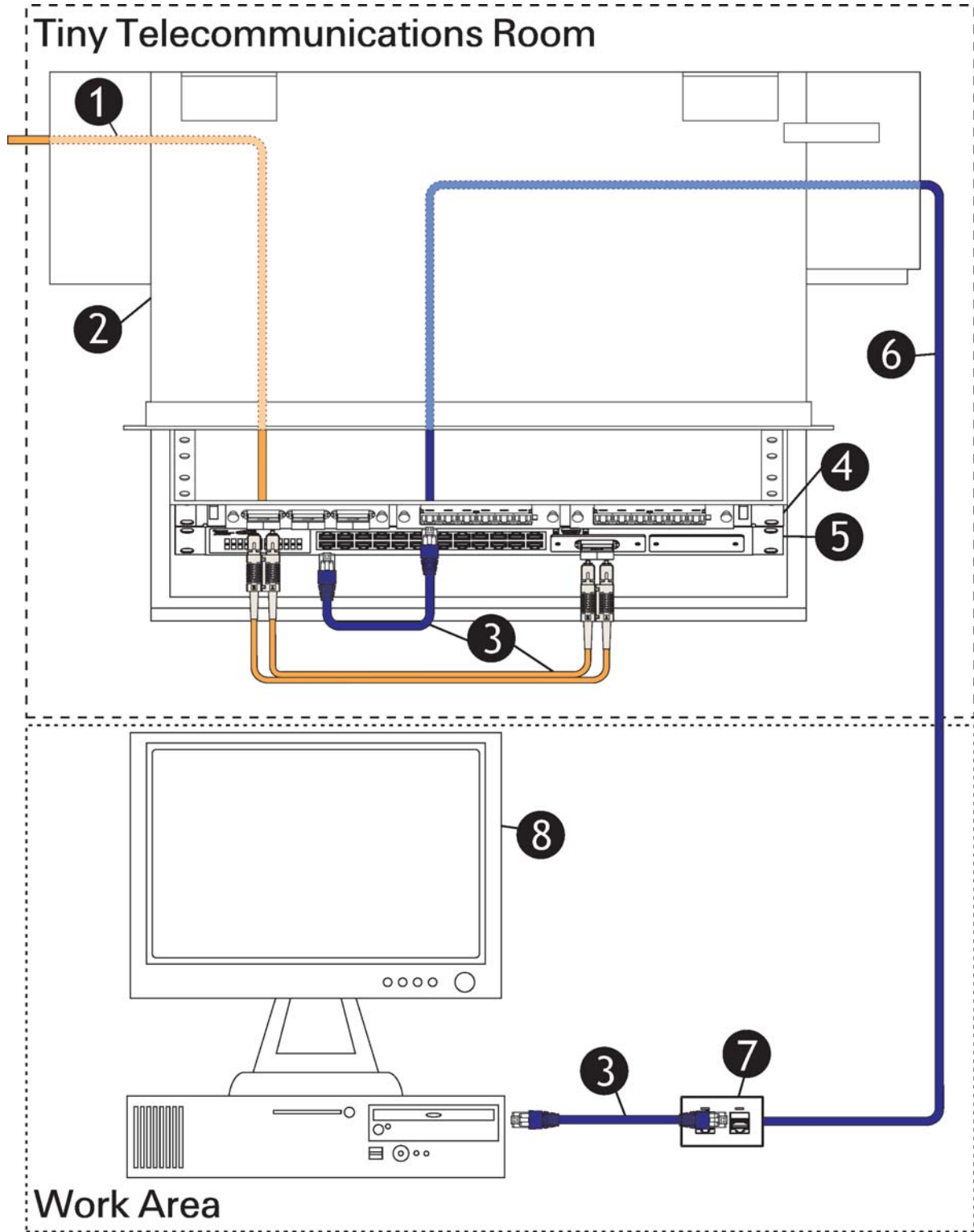

Telecommunications Enclosures ("Tiny TR")

Telecommunications Enclosures ("Tiny TR")

Recent additions to the TIA-568 and TIA-569 standards have allowed a new type of network architecture called Telecommunications Enclosures. This architecture allows an effective combination of optical fiber for longer distance and twisted pair cable for work area outlets. While the concept was initially designed to simplify modular office moves, adds and changes, the concept offers advantages in other types of installations as well - particularly in areas where the horizontal cabling will be changed frequently.

The base of the Telecommunications Enclosure (TE) architecture is the TE itself. Optical fiber backbone cabling is run from the Equipment Room, through the Telecommunications Room (TR) and into the TE where it is terminated and patched to a switch. The output of the switch (RJ45 ports) are then patched to horizontal twisted pair cable to the outlet in the Work Area.

At first glance, this appears to be a displaced TR. However, the requirements for the TE are not the same as for the TR, so there is some additional flexibility when using the TE. It is important to note that the standards do not allow a network without a TR, but in some installations where multiple TRs are needed, TEs may be used in place of additional TRs.

In this example, a 50um optical fiber backbone cable is terminated in SC LightCrimp PLUS connectors. A hybrid patch panel (that can house optical fiber adapters and twisted pair punch down blocks) allows patching the optical fiber backbone to the optical port in the switch. The RJ45 output ports are then patched to the patch panel ports where the horizontal cabling begins.

Telecommunications Enclosures ("Tiny TR")

Item	Part Number	Quantity	Page
1) Horizontal Optical Fiber Cabling			
Distribution Cable, 6-Fiber, 50/125 μm Multimode, OFNP	2-1664039-1	_____	77
SC Duplex LightCrimp PLUS, 50/125 μm Multimode Connectors	6278080-1	_____	95
2) Twisted Pair/Optical Fiber Consolidation Points & Accessories			
Active Equipment Consolidation Point for Drop Ceiling System	1479039-1	_____	195
3) Twisted Pair/Optical Fiber Patch Cable Assemblies			
Category 5e Patch Cable Assemblies	406483-X	_____	29
SC Duplex Patch Cable Assembly, 50/125 μm Multimode	1907379-X	_____	108
4) Optical Fiber Rack Mount Enclosures			119-128
1U Swappable Front Panel Enclosure	1348876-4	_____	123
Duplex SC Snap-in Adapter Plate, 6-Fiber, Multimode	559558-1	_____	121
SL 6-Port Adapter Plate	1479508-1	_____	121
Category 5e SL Jacks	1375191-X	_____	14
5) LAN Electronics			243-252
SNMP Managed Ethernet Switch	1591099-X	_____	248
6) Twisted Pair Cables			3-11
Category 5e, CMP	57825-X	_____	8
7) Twisted Pair Outlets, Faceplates and Accessories - Connectors, Couplers and Adapters			
FLEX-MODE Flush Faceplate, 2-Port	558106-X	_____	189
Category 5e SL Series Modular Jack	1375191-X	_____	14
8) Computer Equipment			

Power over Ethernet (PoE) over Twisted Pair Cabling

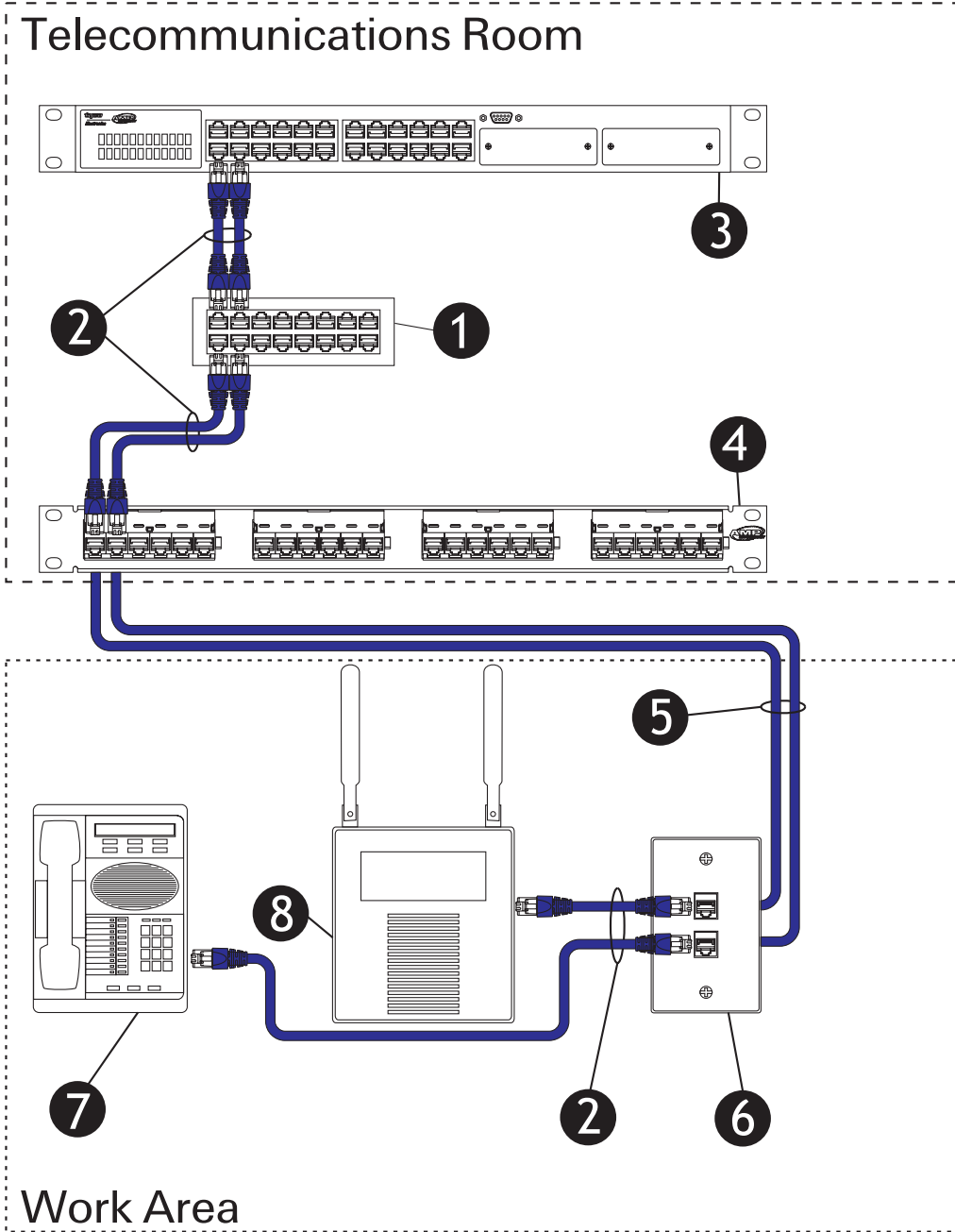

Power over Ethernet (PoE) over Twisted Pair Cabling

Tyco Electronics offers the AMP NETCONNECT 8-Port Power over Ethernet (PoE) Midspan device for 802.3af applications. The AMP NETCONNECT PoE Midspan device offers a cost-effective solution for power remote devices like VoIP phones, WLAN access points, security devices, etc. The AMP NETCONNECT 8-Port PoE Midspan device makes injecting DC power as simple as routing patch cords, eliminates the PoE option costs for powered switch ports and allows routing power only to the outlets where power is needed.

The AMP NETCONNECT Midspan PoE device offers several advantages over end-span devices like powered switches:

- Allows the widest selection of switch vendors and products for PoE - the midspan even adds power to existing switch ports.
- Provides a migration path to PoE without the cost of upgrading to new switches.
- Improves port utilization for PoE ports, and removes the excess heat generation associated with end-span devices

The AMP NETCONNECT 8-Port PoE Midspan device has a universal 110/220 VAC power supply, ideal as a stand-alone device for powering a small number of wireless access points with no external power supply required at the switch, or as a rack-mounted solution that’s stackable to grow as the power needs of your network grow. Up to three midspan devices can be mounted in 1U on standard 19-inch racks for a total of 24 fully powered ports in one rack unit. The fan/power supply is covered under a 2-year warranty. For more information about AMP NETCONNECT 8-Port PoE Midspan device from Tyco Electronics, see Chapter 7 or call your AMP NETCONNECT product sales engineer.

This example system shows a standard LAN switch connected to the AMP NETCONNECT 8-Port PoE Midspan device which adds power to the data signal before connection to the patch panel. Category 6 cabling is installed to the outlet where patch cords connect to standard work area devices or IEEE 802.3af-compliant devices like a wireless access point. Although Category 6 cabling is shown in this example, PoE will run on any 4-pair AMP NETCONNECT category cabling.

Power over Ethernet (PoE) over Twisted Pair Cabling

Item	Part Number	Quantity	Page
1) LAN Electronics			.243-252
PoE Module	1591184-X	_____	.251
2) Twisted Pair Cable Assemblies			.27-32
Category 6 Patch Cable Assemblies	.219884-X	_____	.28
3) LAN Electronics			.243-252
SNMP Managed Ethernet Switch	1591099-X	_____	.248
4) Twisted Pair Patch Panels			.33-50
Category 6 SL Series 24-Port Patch Panels	1375014-X	_____	.35
Category 6 SL Series 48-Port Patch Panels	1375015-X	_____	.35
5) Twisted Pair Cables			.3-11
Category 6, CMP	.219567-X	_____	.5
Category 6E, CMP	1499033-X	_____	.6
6) Outlets, Faceplates and Accessories – Connectors, Couplers and Adapters			
Flush Faceplate, 2-Port	1479444-X	_____	.155
Category 6 SL Series Modular Jack	1375055-X	_____	.13
7) PoE ready phone			
8) PoE ready Wireless Access Point (WAP)			

Open Office Systems

Telecommunications Room

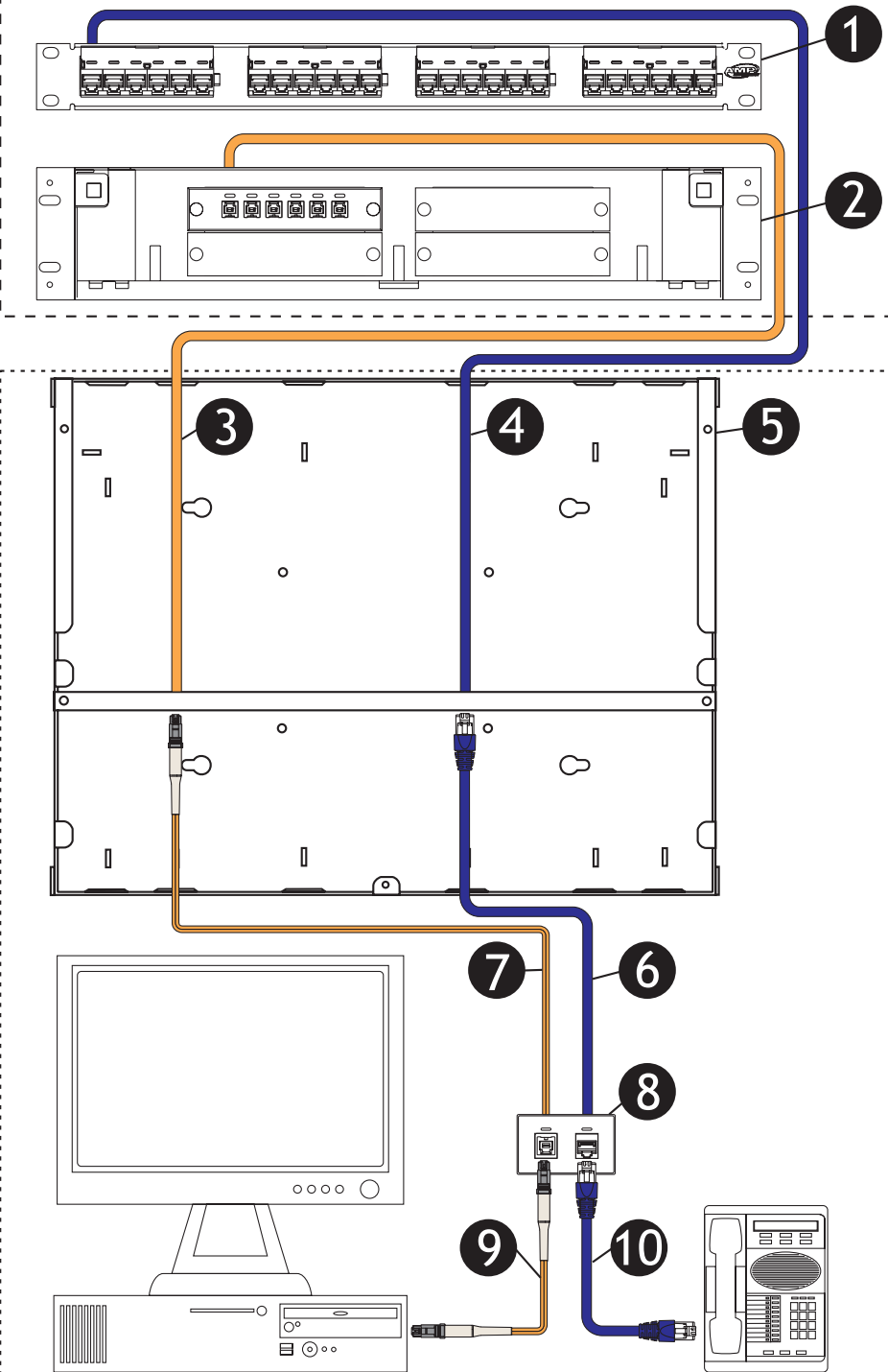

Work Area Zone

Consolidation Point

TIA/EIA Standard – ANSI/TIA/EIA-568-B.1 - Commercial Building Telecommunications Cabling Standard, Part 1: General Requirements defines two styles of horizontal cabling systems specifically geared towards modular furniture and the multi-user telecommunications outlet assembly. Both of these cabling system practices are designed to lessen the amount of “re-cabling” involved in modular furniture moves.

This example system is an illustration of a typical consolidation point application. The consolidation point functions as an interconnect between two sections of the horizontal cabling: the main cabling from the telecommunications closet and shorter distribution cables which serve outlets in the work area. The consolidation point enclosure is typically mounted in the ceiling or under access flooring. When furniture moves are required, only the shorter cables must be reconfigured. Consolidation point modules are available for both optical fiber and twisted pair cabling.

Consolidation Point

Item	Part Number	Quantity	Page
1) Twisted Pair Patch Panels			33-50
Category 6 SL Series 24-Port Patch Panels	1375014-X		35
Category 6 SL Series 48-Port Patch Panels	1375015-X		35
Category 5e SL Series 24-Port Patch Panels	1479154-X		36
Category 5e SL Series 48-Port Patch Panels	1479155-X		36
2) Optical Fiber Rack Mount Enclosures & Connectors, Couplers, Adapters and Mechanical Splices			
2U Rack Mount Enclosure for Standard Optical Fiber Cables	559542-2		125
2U Rack Mount Enclosure for Armored or Trunk Optical Fiber Cables	1435556-1		125
MT-RJ Jack Snap-in Adapter Plate	559558-X		121
MT-RJ Patch Panel Jack, 50/125µm	1588880-1		117
3) Optical Fiber Cabling			75-88
Horizontal Cable, 2-Fiber (Dual), 50/125 µm Multimode, OFNP	2-1664027-1		86
4) Twisted Pair Cables			3-11
Category 6, CMR	219560-X		5
Category 6E, CMR	1499038-X		6
Category 5e, CMR	219538-X		7
Category 5e, CMR	57826-X		8
5) Twisted Pair Consolidation Points & Accessories			
Modular Consolidation Point, 24-Port	406771-1		197
Category 6, 6-Port Modular Jack Modules, SL Series	1375367-1		197
Category 5e, 6-Port Modular Jack Modules, 110Connect	1375367-1		197
MT-RJ, 12-Fiber Optical Fiber Module	1375093-1		198
6) Twisted Pair Patch Cable Assemblies			27-32
Transition Cable Assembly, Category 6, CMR, T568A Wiring	219172-X		31
Transition Cable Assembly, Category 6, CMR, T568B Wiring	219173-X		31
Transition Cable Assembly, Category 5e, CMR, T568A Wiring	219596-X		31
Transition Cable Assembly, Category 5e, CMR, T568B Wiring	219597-X		31
7) Optical Fiber Cable Assemblies			103-112
MT-RJ Patch Cable Assembly, 50/125 µm	6278128-X		106
8) Outlets, Faceplates and Accessories – Connectors, Couplers and Adapters			
FLEX-MODE Flush Faceplate, 2-Port	558106-X		189
Category 6 SL Series Modular Jack	1375055-X		13
Category 5e SL Series Modular Jack	1375191-X		14
MT-RJ Outlet Jacks, 50/125 µm	1278414-X		176
9) Optical Fiber Cable Assemblies			103-112
MT-RJ Patch Cable Assembly, 50/125 µm	6278128-X		106
10) Twisted Pair Patch Cable Assemblies			27-32
Category 6 Patch Cable Assemblies	219884-X		28
Category 5e Patch Cable Assemblies	406483-X		29

Open Office Systems

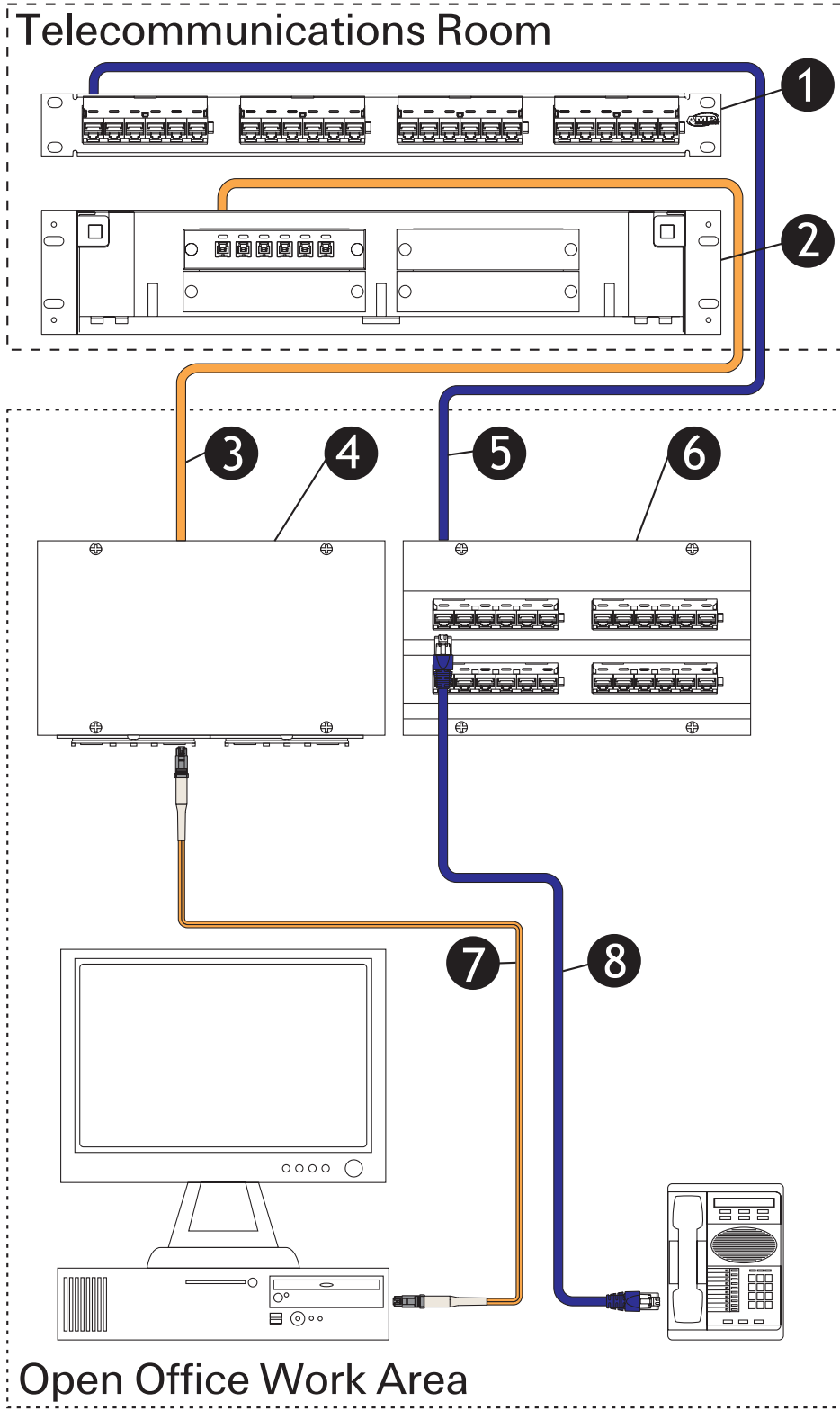

Multi-User Outlet (MUO)

TIA/EIA Standard – ANSI/TIA/EIA-568-B.1 - Commercial Building Telecommunications Cabling Standard, Part 1: General Requirements defines two styles of horizontal cabling systems specifically geared towards modular furniture and the multi-user telecommunications outlet assembly. Both of these cabling system practices are designed to lessen the amount of “re-cabling” involved in modular furniture moves.

This example system is an illustration of a typical Multi-user Telecommunications Outlet Assembly (MUTOA) application. The MUTOA, or simply MUO (for Multi-user Outlet, the common term used in this catalog) is meant to be accessible to users and replaces individual work area outlets. TIA/EIA-568-B.1 allows for the use of work area patch cords longer than the 3 meters specified elsewhere in the standard to accommodate multiple users. Each MUO should be labeled with the longest allowable patch cord according to the table below.

Multi-User Outlet (MUO)

Item	Part Number	Quantity	Page
1) Twisted Pair Patch Panels			33-50
Category 5e SL Series 24-Port Patch Panels	1479154-X		36
Category 5e SL Series 48-Port Patch Panels	1479155-X		36
2) Optical Fiber Rack Mount Enclosures – Connectors, Couplers, Adapters and Mechanical Splices			
2U Rack Mount Enclosure for Standard Optical Fiber Cables	559542-2		125
2U Rack Mount Enclosure for Armored or Trunk Optical Fiber Cables	1435556-1		125
MT-RJ Jack Snap-in Adapter Plate	559558-X		121
MT-RJ Patch Panel Jack, 50/125 μm	6588880-1		93
3) Optical Fiber Cabling			75-88
Horizontal Cable, 2-Fiber (Dual), 50/125 μm Multimode, OFNP	2-1664027-1		86
4) Optical Fiber Outlets, Faceplates and Accessories – Connectors, Couplers, Adapters and Mechanical Splices			
Optical Fiber Multi-User Outlet (MUO)	406817-1		194
Optical Fiber Multi-User Outlet (MUO) Module, MT-RJ Jack	1375347-1		194
MT-RJ Patch Panel Jack, 50/125 μm	6588880-1		93
5) Twisted Pair Cables			3-11
Category 5e, CMR	219538-X		7
Category 5e, CMR	57826-X		8
6) Twisted Pair Outlets, Faceplates and Accessories			149-200
Multi-User Outlet (MUO), Category 5e	406810-1		193
7) Optical Fiber Cable Assemblies			103-112
MT-RJ Patch Cable Assembly, 50/125 μm	6278128-X		106
8) Twisted Pair Cable Assemblies			27-32
Category 5e Patch Cable Assemblies	406483-X		29

Length of Horizontal Cable m (ft)	Maximum Length of Work Area Cable m (ft)	Maximum combined length or work area Cables, Patch Cords and Equipment Cables m (ft)
90 (295)	3 (10)	10 (33)
85 (279)	7 (23)	14 (46)
80 (262)	11 (36)	18 (59)
75 (246)	15 (49)	22 (72)
70 (230)	20 (66)	27 (89)

Centralized Network Administration (CNA) Systems

Main Telecommunications Room

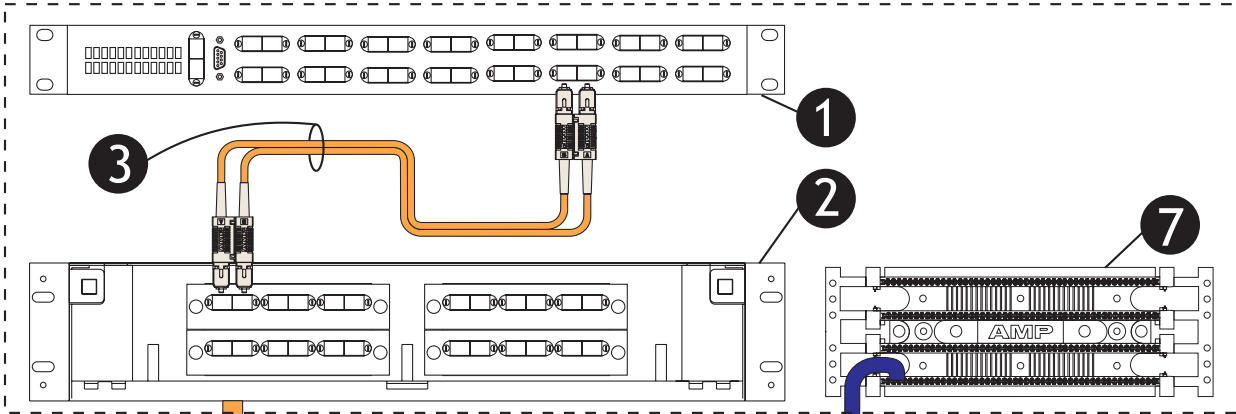

Intermediate Telecom Room

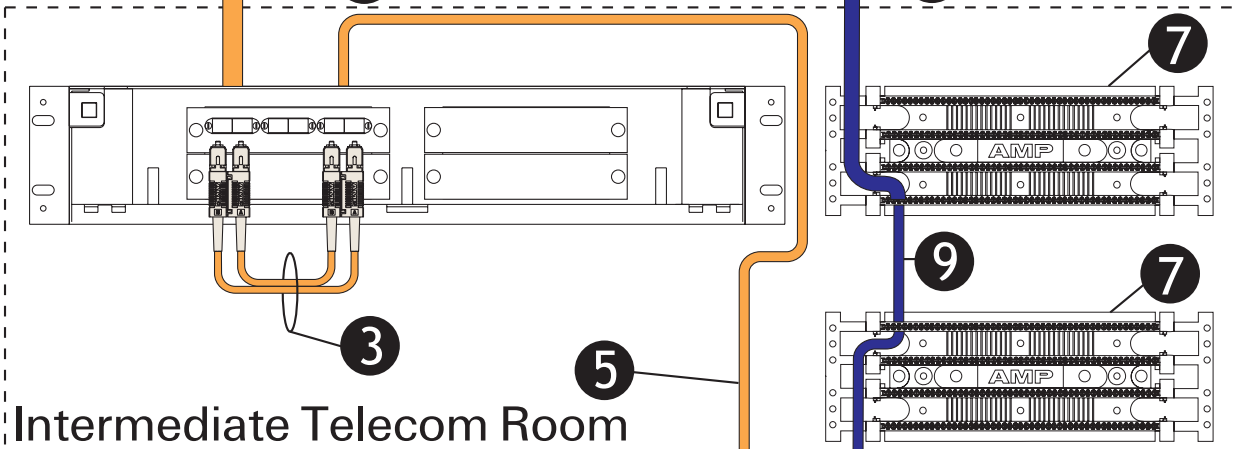

Work Area

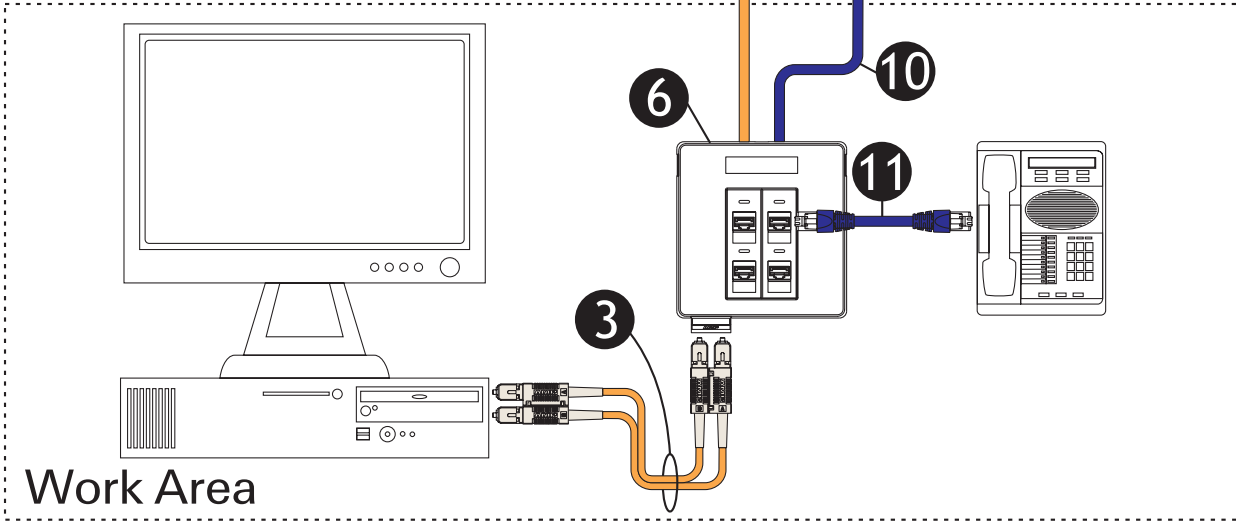

Centralized Network Administration (CNA) Systems

Centralized Network Administration (CNA) Systems

Centralized Network Administration (CNA) is the premier architecture offered by Tyco Electronics to address the increasing operation costs of network administration and the future requirement to easily and cost-effectively migrate from the low-speed LANs of today to the high-speed requirements of tomorrow.

CNA brings all user connectivity to one centralized closet/equipment room within the building versus distributed closets throughout the building. This example shows the components used in a typical CNA system. Please refer to the page numbers listed for further information.

Centralized Network Administration (CNA) Systems

Item	Part Number	Quantity	Page
1) Optical Fiber Switch			
2) Optical Fiber Rack Mount Enclosures – Connectors, Couplers, Adapters and Mechanical Splices			
2U Rack Mount Enclosure for Standard Optical Fiber Cables	559542-2		125
2U Rack Mount Enclosure for Armored or Trunk Optical Fiber Cables	1435556-1		125
Duplex SC Snap-in Adapter Plate, 6-Fiber	559558-X		121
Duplex SC Snap-in Adapter Plate, 12-Fiber	559596-X		121
3) Optical Fiber Cable Assemblies			103-112
Duplex SC Optical Fiber Cable Assembly, 50/125 μm Multimode	1907379-X		108
4) Optical Fiber Cable			75-88
Distribution Cable, 24-Fiber, 50/125 μm Multimode, OFNR	2-1664056-1		78
Distribution Cable, 24-Fiber, 50/125 μm Multimode, OFNP	2-1664056-1		78
5) Optical Fiber Cabling			75-88
Horizontal Cable, 2-Fiber (Dual), 50/125 μm Multimode, OFNR	2-1664026-1		86
Horizontal Cable, 2-Fiber (Dual), 50/125 μm Multimode, OFNP	2-1664027-1		86
6) Faceplates Outlets and Accessories – Connectors, Couplers, Adapters and Mechanical Splices			
HIDEAWAY Multimedia Outlets			159
SL Series 110Connect Modular Jacks, Category 5e	1375191-X		14
7) Twisted Pair Cross-Connects			51-60
110Connect XC Category 5e Cross-Connect, 100-Pair Kit	569439-1		57
8) Twisted Pair Cables			3-11
Category 5e, CMR	219538-X		7
Category 5e, CMP	219513-X		7
Category 5E, CMR	57826-X		8
Category 5E, CMP	57825-X		8
9) Twisted Pair Cables			3-11
Category 5e, CMR	219538-X		7
Category 5e, CMP	219513-X		7
Category 5E, CMR	57826-X		8
Category 5E, CMP	57825-X		8
10) Twisted Pair Cables			3-11
Category 5e, CMR	219538-X		7
Category 5e, CMP	219513-X		7
Category 5E, CMR	57826-X		8
Category 5E, CMP	57825-X		8
11) Twisted Pair Patch Cable Assemblies			27-32
Category 5e Patch Cable Assemblies	406483-X		29

Wireless Systems

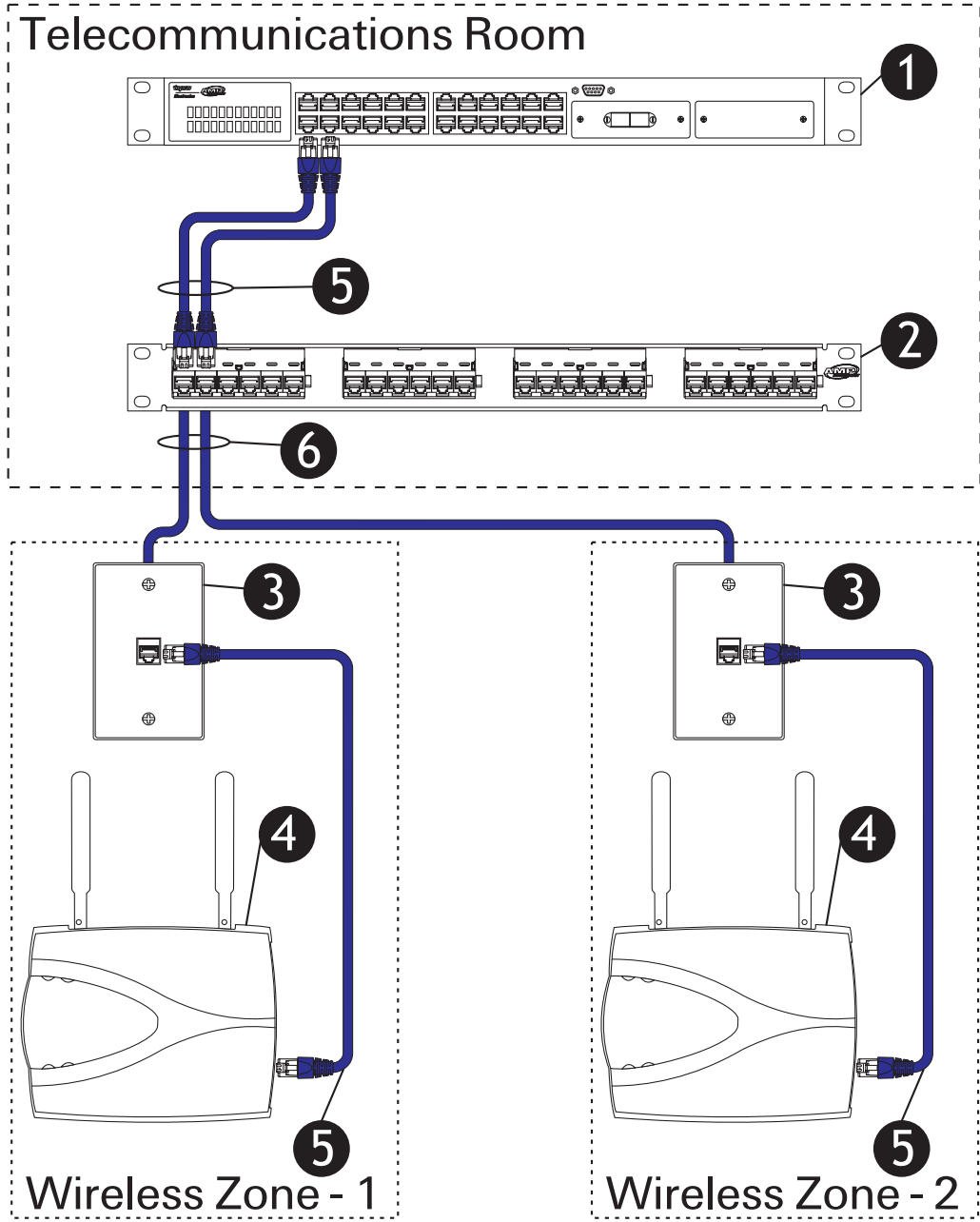

Wireless Systems

Mobility within the work environment has become a necessity with today's workforce. Whether you're moving employees, adding additional workspace, or just don't have time for new cable installation, high-speed wireless networking is the answer. The indoor wireless system provides high-speed network connectivity without cabling. Functioning in the same manner as a wired LAN, the wireless LAN can be utilized by itself or as a complement to an existing wired LAN. Your network remains safe, secure, and reliable.

Wireless Systems

Item	Part Number	Quantity	Page
1) LAN Electronics			243-252
SNMP Managed Ethernet Switch	1591099-X		248
2) Twisted Pair Patch Panels			33-50
Category 6 SL Series 24-Port Patch Panels	1375014-X		35
Category 6 SL Series 48-Port Patch Panels	1375015-X		35
Category 5e SL Series 24-Port Patch Panels	1479154-X		36
Category 5e SL Series 48-Port Patch Panels	1479155-X		36
3) Outlets, Faceplates and Accessories - Connectors, Couplers and Adapters			
Flush Faceplate, 1-Port	1479443-X		155
Category 6 SL Series Modular Jack	1375055-X		13
Category 5e SL Series Modular Jack	1375191-X		14
4) Wireless Access Point			
5) Twisted Pair Patch Cable Assemblies			27-32
Category 6 Patch Cable Assemblies	219884-X		28
Category 5e Patch Cable Assemblies	406483-X		29
6) Twisted Pair Cables			3-11
Category 6, CMR	219560-X		5
Category 6, CMP	219567-X		5
Category 6E, CMR	1499038-X		6
Category 6E, CMP	1499033-X		6
Category 5e, CMR	219538-X		7
Category 5e, CMP	219513-X		7
Category 5E, CMR	57826-X		8
Category 5E, CMP	57825-X		8



Notes

12

320

INDEXES

Product Name Index	322-326
Part Number Index	327-336

Chapter Summary

- A complete listing of product names contained within this catalog
- A complete breakdown of all products and part numbers contained in this catalog

Product Index

0-9

1+1 Outlet Kits	280
10/100BASE-Tx Impedance Matching Adapters	24
110 Punch Down Tool Replacement Blades	68
110 Punch Down Tools with Blades	68
110 Telecom Bridge Module	283
110Connect Category 3 Modular Jacks	16,166
110Connect Category 5e Modular Jacks	16,166
110Connect Category 5e Shielded Modular Jacks	16,166
110Connect Category 5e Unshielded Modular Jacks	16,166
110Connect Modular Jack Patch Panels	42
110Connect Stuffer Caps	16,166
110Connect XC Cable Management	58
110Connect XC Category 5e Cable Assemblies	30
110Connect XC Connecting Blocks	56
110Connect XC Cross-Connect Distribution Frame Kits	58
110Connect XC Cross-Connect Rack Mount Panel	59
110Connect XC Cross-Connect System	56-59
110Connect XC Kits	58
110Connect XC Wiring Blocks	57
1-2 Fiber Interconnect Cables	87
12-Fiber Optical Fiber Modules	198
12-Port Universal Office Box	170
16-Port Compact Ethernet Switch	245
18-Port Patch Panel	285
1U (1.75-inch) MT-RJ Jack Rack Mount Patch Enclosure	124
1U (1.75-inch) SC and ST Rack Mount Patch Enclosures	124
1U Rack Mount Fiber Optic Patch Panel	122
1U Rack Mount Patch Enclosures	123
2 and 3 Gang AFWM Lid Replacement Kit	186
2 Gang AFWM	186
2+1 Outlet Kits	280
2+2 Outlet Kits	280
2-4 Fiber Horizontal Cables	86
24-Fiber LC SECURE Snap-in Adapter Plates	207
24-144 Fiber Armored Outside Plant Cables	85
24-144 Fiber Dielectric Outside Plant Cables	82
24-144 Fiber Indoor/Outdoor Cables	80
24-72 Fiber Distribution Cables	78
24-Port Compact Ethernet Switch	245
24-Port PoE Midspan Device	251
24-Port Smart Ethernet Switch II with Optional Dual Uplink Port	247
24-Port Stackable Managed Switch with Expansion Port	248
2U Rack Mount Fiber Optic Patch Panel	122
2U Rack Mount Patch Enclosures	125
3 Gang AFWM	185
3U Rack Mount Patch Enclosures and Accessories	125
4 Gang AFWM	185
4-12 Fiber Armored Outside Plant Cables	83
4-12 Fiber Dielectric Outside Plant Cables	81
4-12 Fiber Indoor/Outdoor Cables	79
4-Position Data Connector to Modular Jack Adapters	25
4U Rack Mount Patch Enclosures and Accessories	126
5 Gang AFWM (Environmental Air-Space Use)	184
5 Gang AFWM (Non-Environmental Air-Space Use)	185
5-Port Compact Ethernet Switch	244

610XC 4- and 5-Pair Category 6 Connecting Blocks	53
610XC 4-Pair Punch Down Tool	69
610XC Cable Management	54
610XC Category 6 Cable Assemblies	30,55
610XC Category 6 Cross-Connect Distribution Frame Kits	54
610XC Category 6 Cross-Connect Kits	53
610XC Category 6 Cross-Connect System	52-64
610XC Category 6 Wiring Blocks	53
610XC Rack Mount Cross-Connect Panel Kits	55
6-12 Fiber Distribution Cables	77
6-Port Modular Jack Modules	197
8-Port Compact Ethernet Switch	244
8-Port PoE Midspan and Accessories	251
8-Port Smart Ethernet Switches with Fiber Uplink Ports	246

A

A-BUS Audio System Components	289
Access Floor Workstation Modules	184-187
Accessories for Rack Mount Enclosures	128
ACO Double Gang Dual-Port Faceplate Kits	174
ACO Double Gang Recessed Box & Accessories	175
ACO Dual-Port Installation Kits	46,172,173
ACO Dual-Port Patch Panel Kit, 16-Port	46
ACO Edge Connector Assembly	182
ACO Ground Shield Kit	182
ACO Inserts for 100 Ohm cable	178
ACO Inserts for 150 Ohm 2-Pair Shielded Cable	181
ACO Modular Jacks	180
ACO Optical Fiber Double Gang, Dual-Port Faceplate Kits	174
ACO Patch Panels	43-46
ACO SEMTRON Faceplates	175
ACO Single Gang Dual-Port Faceplate Kits	174
ACO Single-Port Faceplates For Modular Furniture	177
ACO Single-Port Faceplates For Panel Mount	177
ACO Single-Port Installation Kits	45
ACO Single-Port Patch Panel Kits, Preloaded	44
ACO Single-Port Patch Panel Kits, Unloaded	45
Active Video Modules	287
Adapter for 89B Bracket	57
AFWM Flush Faceplates	187
AMP Communications Outlet (ACO)	170-182
AMP CORELINK Splice Workstation	145
AMP Furniture Outlet	177
AMP NETCONNECT Ethernet LAN Switches	244-245
AMP NETCONNECT Ethernet Media Converters	249-250
AMP NETCONNECT Power over Ethernet Products	251
AMP NETCONNECT Smart Ethernet Switches	246-245
AMP NETCONNECT SNMP Managed Ethernet Switches	248-249
AMP-BARREL Wire Insertion Tools	72
AMPTRAC Analyzer I/O Cable Assemblies	238
AMPTRAC Cable Management	233
AMPTRAC Connectivity Management System Products	229-242
AMPTRAC Analyzers	232
AMPTRAC I/O Cable Management Brackets	239
AMPTRAC LAN Electronic Sensor Strip	236
AMPTRAC MRJ21 Shielded Patch Panels	234
AMPTRAC Optical Fiber Patch Cable Assemblies	237

Product Index

AMPTRAC Optical Fiber Patch Panels and Accessories235
 AMPTRAC Patch Panel Retrofit Kits234
 AMPTRAC Shielded Patch Panels234
 AMPTRAC Twisted Pair Patch Cable Assemblies237
 AMPTRAC Twisted Pair Patch Panels233
 AMP-TY Nylon Cable Ties48,227
 Angled Faceplates154

B

Blank Panels50
 Blank Snap-In Adapter Plates120-121

C

Cable5-9,76-88
 Cable Assemblies27-32,103-112,204-209,237,285
 Cable Management213-228
 Cable Management Bracket34,40
 Cable Raceway System218-222
 Cable Spools216
 Cable Strap Mounts217
 Cable Strippers and Cutters69
 Cable Support Bars47,63,226
 Cable Support Brackets63
 Cat 5e Connectivity Module283
 Category 3 25-Pair Patch Panels39
 Category 3 Modular Plugs21
 Category 3 Patch Panels38
 Category 5 F/UTP Patch Cable Assemblies29
 Category 5 UTP Cable9
 Category 5, 10/100BASE-T, RJ21 (25-Pair) Cable Assemblies38
 Category 5, 10/100BASE-T, RJ21 (25-Pair) Patch Panel38
 Category 5e 110Connect Patch Panels37
 Category 5e 25-Pair Cable7
 Category 5e 4-Pair Cable7
 Category 5e Angled 110Connect Patch Panels37
 Category 5e Angled SL Series Patch Panels36
 Category 5e Dual ACO Inserts179
 Category 5e F/UTP Cable8
 Category 5e Integrated Cable Management
 110Connect Patch Panels37
 Category 5e Modular Plugs21
 Category 5e Multi-User Outlet (MUO)193
 Category 5e Patch Cable Assemblies29
 Category 5e Patch Panels and Accessories37
 Category 5e Patch Shielded Cable Assemblies29
 Category 5e Patch Unshielded Cable Assemblies29
 Category 5E SL Series Patch Panels36
 Category 5e UTP Cable (200 MHz)7
 Category 5E UTP Cable (350 MHz)8
 Category 6 & 5e Single ACO Inserts178
 Category 6 ACO Single-Port Patch Panel, Preloaded43
 Category 6 Angled SL Series Patch Panels35
 Category 6 Modular Plug Hand Tool and Die Set70
 Category 6 Patch Cable Assemblies28
 Category 6 Patch Panels35
 Category 6 RJ45 SECURE Patch Cable Assemblies211
 Category 6 SL Series Patch Panels35

Category 6 UTP Cable5
 Category 6, 8-Position Modular Plug Kits20
 Category 6, ACO Single-Port Patch Panel Kits, Preloaded43
 Category 6A F/UTP (SCTP) Cable5
 Category 6A Patch Panels34
 Category 6A Shielded Patch Cable Assemblies28
 Category 6E UTP Cable6
 Centralized Fiber Network with LC Connectors303-304
 Centralized Network Administration (CNA) System316-317
 CHAMP Category 3 Telco Adapters23
 CHAMP Category 3 Telco, 25-Pair, Unshielded Connector Kits23
 C-LOK, Solid and Stranded Copper Bonding Connectors50
 Clear Label Holder for 610XC and 110Connect XC Wiring Blocks258
 Coax Patch Cables288
 Compression Tool for AMP-BARREL Edge Connectors72
 Concrete Form Boxes from Barthelmes186
 Connectors, Couplers and Adapters11-26,89-101
 Consolidation Point Transition Cable Assemblies31
 Consolidation Points and Accessories195-199
 Consolidation Points for Drop Ceiling Systems195
 Consolidation Points for Raised Floor Systems196
 CORELINK Optical Fiber Splices99
 Couplers & Adapters (Fiber)100
 Cover for Angled Patch Panels49
 Cross-Connect Consolidation Point199

D

Deluxe Premises Termination Tool Kit137
 Demarcation Jack Kit285
 Desktop Monuments188
 Discrete High Density Angled SL Series Patch Panels41
 Discrete Multimedia SL Series Patch Panel41
 Double-Sided Combination Cable Managers215
 Double Sided, Double Door Wall Mount Patch Enclosure130
 Double Sided, Double Door Wall Mount Splice and Patch Enclosures132
 Double Sided, Single Door Wall Mount Patch Enclosure130,131,133
 Double Sided, Single Door Wall Mount Splice and Patch Enclosure133
 Double Sided Vertical Cable Managers214
 DSL Connectivity Starter Kit284
 DSL/Security Module283
 Dual LNB Satellite/Coax Demarcation Module288

E

EPO-TEK 353ND Epoxy142
 Epoxy Applicator Syringe143
 Epoxy Curing Oven143
 Epoxy/Polish Connector Termination Tool Kits141
 Epoxy/Polish Connectors97-99
 Epoxy/Polish LC Connectors97
 Epoxy/Polish LC Termination Accessories142
 Epoxy/Polish SC Connectors98
 Epoxy/Polish ST Connectors99
 Ethernet Crossover Cable Assemblies29
 EtherSeal Cable & Conduit Glands267
 EtherSeal Category 5e Cable263
 EtherSeal Category 5e Patch Cable Assemblies265
 EtherSeal Enclosures267

Product Index

EtherSeal Modular Coupler Outlet Kits	264
EtherSeal Modular Jack Outlet Kits	264
EtherSeal Modular Plug Kits	265
EtherSeal Products	261-267
EtherSeal Stainless Steel Faceplates	266
Extenders & Adapters for Furniture Faceplates	191
External Strain Reliefs For Modular Plugs	22

F

Faceplates for Mounting Straps	157
Fasteners	217
Fast Ethernet Media Converters	249
Fiber Optic Cleave Tool	139
Field Terminable 110Connect XC Patch Plugs	22
Finger Bracket	216
FLEX-MODE Modular Furniture Faceplate Accessories	192
FLEX-MODE Modular Furniture Faceplates Kits	189
Flush Faceplate for Herman Miller Furniture	190
Flush Faceplates	155

G

Gate Kit	215
Gigabit Ethernet Media Converters	250
Grounding Lug Kit	50

H

Hand Held Cleaver	139
HIDEAWAY Multimedia Outlet Accessories	160
HIDEAWAY Multimedia Outlets	159
HIDEOUT Outlets	158
High Density ACO Single-Port Patch Panel Kit	44
High Density Vertical Cable Management	214
Hinged Patch Panel Accessories	47
Hinged Wall Brackets for 19-Inch Panels	49
HOME NET-WORKS Products	275-292
Horizontal Finger Duct Panels	233
Horizontal Management	217
Horizontal Ringed Cable Management Panels	233
HYSOL Epoxy-Tubes	142

I

IBM 3270 Baluns	25
IBM AS/400 Baluns	24
Icon Wheels	259
Insertion/Extraction Tools	73
Inserts for 110Connect Modular Jack Patch Panels and Standard 0.582" x 0.762" Openings	42
Inspection Microscope	144
iTRACS® Infrastructure Manager™ Software	240-241

K

Keystone Category 3 Modular Couplers	17
Keystone Category 5e Modular Couplers	17

L

Label Covers for Faceplates	256
Label Covers for Patch Panels	257

Labeling & Identification	253-260
Labels for 610XC and 110Connect XC Cross-Connect Wiring Blocks	258
Labels for Cable and Cable Assemblies	258
Labels for Patch Panels	257
LAN Electronics	243-252
LC Cable Assemblies	109
LC Coupler	100
LC Duplex Clip	205,206
LC Pigtail (Single-Ended) Cable Assemblies	110
LC SECURE Duplex Hybrid Cable Assemblies	208
LC SECURE Epoxy/Polish Connectors	206
LC SECURE LightCrimp PLUS Connectors	205
LC SECURE SL Series Duplex Couplers	207
LC Snap-In Adapter Plates	120,121
LC Test Kits	112
LightCrimp Cleave Tool	140
LightCrimp Connectors	96
LightCrimp PLUS Cable Holders	139
LightCrimp PLUS Connectors	95
LightCrimp PLUS LC Connectors	97
LightCrimp PLUS SC Connectors	98
LightCrimp PLUS ST Connectors	99
LightCrimp PLUS Termination Tool Kits	137
LightCrimp SC Connectors	96
LightCrimp ST Connectors	96
LightCrimp Termination Tool Kits	140

M

Media Convergence Center Accessories	292
Mini Multi-User Outlet (MUO)	193
Miscellaneous ACO Inserts	181
Modular Consolidation Points	197
Modular Consolidation Points and Accessories	197-199
Modular Jack Boxes	170
Modular Plug Boots	22
Modular Plug Boots for Category 6 Plugs	20
Mounting Straps	157
MPO Optical Fiber Cassettes	117
MPO Products	114-118
MPO SECURE Optical Fiber Cassettes	117
MPO SECURE Trunk Cable Assemblies	209
MPO Trunk Cable Assemblies	104,105,116
MRJ21 Products	62-64
MRJ21 Cable Assemblies	31,64
MRJ21 Cassette Panel	62
MRJ21 Cassettes	62
MRJ21 Patch Panels	63,234
MTP/MTO In Bulkhead Cleaner	146
MT-RJ Cable Assemblies	106
MT-RJ to SC Cable Assemblies	106
MT-RJ to ST Cable Assemblies	107
MT-RJ Bend-Limiting Boots	94
MT-RJ Couplers	100
MT-RJ Jack Termination Tool Kit	137
MT-RJ Loopbacks	111
MT-RJ OTDR Test Assemblies	111
MT-RJ Outlet Jacks	92

Product Index

MT-RJ Parallel Dress Clips	94
MT-RJ Patch Panel Jacks	93
MT-RJ Pigtail Jack (Single-Ended) Cable Assemblies	110
MT-RJ Pigtail Plug (Single-Ended) Cable Assemblies	110
MT-RJ Plug to MT-RJ Right Angle Jack	107
MT-RJ SECURE Hybrid Cable Assemblies	204
MT-RJ SECURE Outlet Jacks	202
MT-RJ SECURE Patch Panel Jacks	203
MT-RJ SECURE Segregated Networks	301-302
MT-RJ Snap-In Adapter Plates	120,121
MT-RJ Test Kits	111
MT-RJ to LC Cable Assemblies	107
Multimedia SL Series Patch Panels	40
Multimedia Integrated Cable Management SL Series Patch Panels	40
Multimedia Patch Panels	40-41
Multimedia Security Outlet	167
Multimedia SL Series Patch Panels	40

N

NEOCLEAN Stick Cleaner	147
No-epoxy/No-polish Upgrade and Adaptive Termination Tool Kits	138

O

Open Office Consolidation Point	313-314
Open Office Multi-User Outlet (MUO)	315-316
Optical Fiber Cable Assemblies	102-112
Optical Fiber Cabling	76-87
Optical Fiber Connectors, Mechanical Splices, Couplers and Adapters	89-101
Optical Fiber Consolidation Points and Accessories	195-199
Optical Fiber Data Center/SAN Products	113-118
Optical Fiber Distribution Cables	77-78
Optical Fiber Horizontal Cables	86
Optical Fiber Indoor/Outdoor Cables	79-80
Optical Fiber Interconnect Cables	87
Optical Fiber Multi-User Outlet (MUO)	194
Optical Fiber MUO Fiber Modules	194
Optical Fiber SL Series Multimedia Inserts	162
Optical Fiber Outlets, Faceplates and Accessories	152-194
Optical Fiber Outside Plant Cables	81-84
Optical Fiber Rack Mount Enclosures and Accessories	119-128
Optical Fiber Tools and Accessories	135-148
Optical Fiber Wall Mount Enclosures and Accessories	119-128
OPTIPOP C Card Optical Connector Cleaner	147
OPTIPOP R Reel Optical Connector Cleaner	147
Outlet Cable	281
Outlet Faceplates and Straps	281
Outlet Jacks and Inserts	281
Outlets, Faceplates and Accessories	152-194
OVDA Duplex LC Receptacles and Plugs	266

P

Palm Grip Hand Tool Kits	73
Palm Grip Tool	69
PARA-OPTIX Backbone Enclosure Kit	115
PARA-OPTIX Trunk Assembly	115
Passive Video Modules	286

Patch Cords	27-32,103-112,204-209,237,285
Patch Panel Accessories	49-50
Pistol Grip Tool for AMP-BARREL Edge Connectors	71
Polishing Bushings, Curing Sleeves, and Strip Card Kit	145
Polishing Films	143
Portable "Butterfly" Hand Tool (M-1) for CHAMP 25-Pair Connectors	72
Power and Undercarpet Products	269-274
Power over Ethernet (PoE) over Twisted Pair Cabling System	310-311
PRO-CRIMPER III Hand Tool and Die Sets for Twisted Pair Applications	70
PRO-CRIMPER III Hand Tool and Optical Fiber Die Sets	146
Products for WIREMOLD Raceways	183
Pro-Installer Epoxy/Polish Connector Termination Tool Kits	141
Pro-Installer Twisted Pair Tool Kit	68
Pro-Installer's Modular Plug Hand Tool	70
Pro-Installer's Modular Plug Hand Tool Kits and Accessories	71

R

Rack Management	214-217
Rack Mount Cable Management Rings	225
Rack Mount Cable Management Rings, Vertical	225
Rack Mount Cable Trough, Bottom/Middle	224
Rack Mount Cable Trough, Top	224
Rack Mount Enclosures and Accessories	119-128
Rack Mount Fiber Management Enclosures and Accessories	126
Rack Mount Media Converter Chassis System	250
Rack Mount Splice and Patch Enclosures, 2U (3.50-inch)	128
Rack Mount Splice Enclosures	127
RCS 36 Video Patch Panel	288
RCS Basic Starter Kit	284
RCS Connectivity Expansion Panel	284
RCS Connectivity Starter Kit	284
RCS14 Media Convergence Center	290
RCS28 Media Convergence Center	290
RCS36 Media Convergence Center	291
Replacement Components for LC Test Kits	112
Replacement Components for MT-RJ Test Kits	111
Replacement Door Kits	215
Replacement Gates	216
RJ45 SECURE SL Series Category 6 Modular Jacks	211

S

SAN and Data Center MPO High Density Optical Fiber Cabling System	307-308
SAN and Data Center MRJ21 High Density Copper Cabling System	305-306
Sapphire-Tipped Scribe Tool and Accessories	145
SC Cable Assemblies	108
SC Coupler	100
SC Pigtail (Single-Ended) Cable Assemblies	110
SC Snap-In Adapter Plates	120-121
SC to LC Cable Assemblies	108
SC to ST Cable Assemblies	108
SC to ST Coupling Adapter	100
Security Panel Mounting Accessories	292
Side Cover Panel	215

Product Index

Single Sided, Single Door Wall Mount Patch Enclosure130

SL Series 110Connect Category 3 Modular Jacks16

SL Series 2-Fiber, SC Duplex Multimedia Modules101,153

SL Series 2-Port (Straight/Angled) Faceplate Modules153

SL Series 3.5 mm Stereo, Mini-headphone,
Solder Termination Multimedia Inserts19

SL Series 3-Port Faceplate Modules153

SL Series Binding Post Multimedia Inserts19

SL Series Blank Faceplate Modules153

SL Series Blank Multimedia Inserts19,101

SL Series BNC Coupler Multimedia Inserts19

SL Series Category 3 Modular Jacks14,164

SL Series Category 5e Modular Jacks14

SL Series Category 5e Shielded Modular Jacks14

SL Series Category 5e Unshielded Modular Jacks14

SL Series Category 6 Modular Jacks13,163

SL Series Category 6 Shielded Modular Jacks13

SL Series Category 6 Unshielded Modular Jacks13

SL Series Category 6A Shielded Modular Jacks13,63

SL Series Modular Jack Strain Reliefs14

SL Series Modules153

SL Series Faceplates152

SL Series F-Connector Coupler Multimedia Inserts19

SL Series Furniture Outlets190

SL Series LC Coupler Multimedia Inserts101

SL Series Modular Jack Strain Reliefs14,164

SL Series Modular Jack Termination Tool and Accessories67

SL Series Modules153

SL Series MT-RJ Housing101

SL Series Multimedia Inserts19,161,162

SL Series Multimedia Jacks18,162

SL Series Optical Fiber Multimedia Inserts101

SL Series Optical Fiber Multimedia Modules101

SL Series RCA Coupler Multimedia Inserts19

SL Series RCA Multimedia Jack19

SL Series RCA, Solder Termination Multimedia Inserts19

SL Series Shielded Multimedia Patch Panels40

SL Series Snap-In Adapter Plates120,121

SL Series Speaker Post Multimedia Inserts19

SL Series ST Coupler Multimedia Inserts19,101

SL Series SVGA (Loaded/Unloaded) Multimedia Modules153

SL Series S-Video Multimedia Jack18

SL Series Toolless Category 3 Modular Jacks15,165

SL Series Toolless Category 5e Modular Jacks15,165

SL Series Toolless Category 5e Shielded Modular Jacks15,165

SL Series Toolless Category 5e Unshielded Modular Jacks15,165

Snap-In Adapter Plates120-121

Splice Accessories for Rack Mount Splice and Patch Enclosure125

Splice Accessories for Wall Mount Splice and Patch Enclosure132

Splice Trays and Accessories for 3U and
4U Rack Mount Splice Enclosures127

ST Cable Assemblies109

ST Coupler100

ST Snap-In Adapter Plates120-121

Stainless Steel Faceplates from Semtron156

Standard ACO Single-Port Installation Kits176

Standard Faceplate for Herman Miller Furniture191

Standard Faceplates154

Standard Faceplates for Herman Miller Furniture191

Standard Labels for Outlets255

Standard Telecom Bridge282

Stationary, Ventilated Shelf50

Surface Boxes170

Surface Mount Outlet168

SVGA Assembly18

System Layouts293-319

T

Telecom Bridge/Security282

Telecommunications Enclosures ("Tiny TR") System308-309

Telephone Line Designation Cords285

Tools66-74,135-148

TRA-CON Epoxies142

Twisted Pair AMP Communications Outlet (ACO) System299-300

Twisted Pair Cable Assemblies27-32

Twisted Pair Cabling4-10

Twisted Pair Connectors, Couplers and Adapters11-26

Twisted Pair Consolidation Points and Accessories195-199

Twisted Pair Cross-Connect Systems51-59

Twisted Pair Data Center/SAN Products62-64

Twisted Pair Outlets, Faceplates and Accessories149-194

Twisted Pair Patch Panels33-50

Twisted Pair Shielded XG (10 Gb/s) System295-296

Twisted Pair SL Series Multimedia Inserts19,161

Twisted Pair Testing Tools74

Twisted Pair Tools66-74

Twisted Pair Unshielded System297-298

U

Universal Labels256

Universal Office Boxes and Accessories169

Unloaded Connectivity Panel282

V

VELCRO Cable Ties48,227,292

Vertical Finger Duct Panels223

Vertical Ringed Cable Management Panels224

W

Wall/Furniture Mounting Bracket131

Wall Mount Enclosures and Accessories119-128

Wireless System318-319

WIREMOLD 2A Inserts183

WIREMOLD Raceway Faceplates183

X

XG Category 6A AMP-TWIST F/UTP Patch Cable Assemblies34

XG Category 6A AMP-TWIST F/UTP Shielded Modular Jacks13,163

XG Category 6A F/UTP Patch Cable Assemblies28

Part Number Index

1

1085 CT	72	1278949	136,137	1375202	12,20,66	1435440	120
122533	71	1278997	142	1375204	12,20,66	1435467	133
124235	270	1339015	15,165	1375216	291	1435516	120,203
147155	47,226	1339118	150,151,152,254	1375241	91,101,153	1435555	123
172150	233	1339119	150,151,152,254	1375253	48,227,292	1435556	125,307, 313,315,317
1116044	257	1339120	150,151,157,281	1375254	48,227,292	1435557	125
1116098	91,151,168,254	1339123	91,101,162	1375255	48,227,292	1435558	126,307
1116111	151,168	1339124	19,161	1375256	48,227	1435574	123
1116360	188	1339188	15,165	1375257	223	1435593	235
1116406	91,150,151,153,254	1339189	15,165,281	1375258	223	1435594	235
1116407	153	1348876	123,309	1375259	223	1435652	128
1116408	91,150,151,153,254	1348960	124	1375260	223	1435653	235
1116409	91,150,151,153	1374205	91,94,160	1375272	291	1435657	235
1116410	153	1374206	91,94,160	1375288	150,151,189	1435672	235
1116412	19,101,161,162,281	1374416	91,101,162	1375289	40	1435673	235
1116515	16,166	1374463	120	1375306	91,101,153	1435685	235
1116535	150,151,167,254	1374484	136,143	1375307	68	1435688	235
1116571	69	1374526	132	1375308	68	1435689	235
1116580	189	1374598	121	1375309	68	1435724	237
1116603	15,165	1375005	150,151,190,254	1375310	68	1435725	237
1116604	15,165,281	1375006	150,151,190,254	1375317	69	1435726	237
1116616	150,151,157,281	1375013	35	1375345	254,256	1435726	237
1116618	150,151,157,281	1375014	35,47,226, 297,311,313,319	1375347	91,194,315	1435735	91,303
1116695	150,151,187	1375015	35,47,226, 297,311,313,319	1375351	257	1435779	239
1116697	150,170,254	1375016	35,47,226	1375352	257	1435789	237
1116698	150,170,254	1375049	150,151,183,254	1375353	254,256,257	1435790	237
1116700	184	1375050	150,151,183,254	1375354	63,115,258	1435791	237
1116732	38	1375055	13,163,281, 297,311,313,319	1375355	258	1435792	237
1116733	38	1375092	259	1375356	254,255	1435793	237
1116734	38	1375093	198,313	1375357	254,255	1435794	237
1199891	222	1375092	259	1375358	254,256	1435795	237
1201266	123,124	1375093	198,313	1375359	19,161	1435796	237
1201816	222	1375123	91,101,153	1375360	19,161	1435797	237
1206114	124	1375123	91,101,153	1375361	19,161	1435799	91
1206138	124	1375149	18,162,281	1375362	19,161	1435808	126
1206144	126	1375155	150,151,154,254	1375363	19,161	1435818	236
1206145	126	1375156	41	1375364	19,161	1435820	236
1206146	126,131	1375157	14,164	1375365	19,161	1435827	236
1206704	124	1375158	223	1375366	19,161	1435834	237
1278017	100	1375159	223	1375367	197,313	1435835	237
1278022	136,137	1375160	223	1375376	193	1435839	127
1278023	139	1375161	223	1375376	193	1435844	233,235,238
1278118	136,137	1375162	223	1375398	286	1435845	238
1278323	130	1375163	223	1435049	50	1435847	122
1278328	120,301	1375163	223	1435118	112	1435849	236
1278346	136,137	1375164	223	1435119	112	1435860	237
1278368	121	1375165	223	1435128	131	1435861	237
1278414	313	1375166	223	1435129	133	1435862	237
1278567	121	1375167	223	1435130	133	1435862	237
1278755	132	1375187	13,163,281	1435161	126	1435863	237
1278807	203	1375188	13,163	1435187	125	1435864	237
1278808	203	1375189	14,164	1435346	236	1435918	237
1278861	111	1375190	14,164,281	1435351	237	1435919	237
1278862	111	1375191	14,164,281, 297,309,313,317,319	1435352	237	1435927	236
1278863	111	1375192	14,164	1435353	237	1435933	236
		1375193	14,164	1435355	237	1435937	236
		1375200	14,164	1435356	237	1435939	236
				1435357	237	1435950	236

Part Number Index

1435952	236	1479248	53	1479398	169	1479622	55
1435953	237	1479249	53	1479402	47	1479623	55
1435954	236	1479250	53	1479437	292	1479624	55
1435965	63	1479251	53	1479440	292	1479625	157,281
1435971	63	1479252	53	1479441	285	1479654	267
1435990	127	1479253	53	1479443	150,151,	1479655	267
1457062	100	1479254	53,297,299		155,281,319	1479656	267
1457628	142,143	1479255	53	1479444	150,151,155,281,	1479657	267
1457630	145	1479256	53		295,297,301,303,311	1479658	267
1475194	47,226	1479257	53	1479445	150,151,155,281	1479659	267
1479002	259	1479258	54	1479446	150,151,155,281	1479682	12,66,265
1479003	259	1479259	54	1479447	150,151,155,281	1479683	12,66,265
1479004	285	1479260	54	1479449	40,47,226	1479696	197
1479005	285	1479261	54	1479450	40,47,226	1479697	282
1479006	285	1479265	30,55	1479451	62	1479698	282
1479007	288	1479266	30,55	1479452	62	1479699	282
1479008	288	1479267	30,55	1479459	62	1479700	282,283
1479009	288	1479268	254,256	1479486	150,151,152,254	1479701	282
1479014	290	1479282	292	1479488	150,169,254	1479702	282
1479039	195,309	1479283	288	1479489	150,169,254	1479703	282,283
1479040	195	1479285	285	1479490	150,169,254	1479704	284
1479041	195	1479286	288	1479494	169	1479705	284
1479042	196	1479287	18	1479495	91,169	1479706	284
1479079	18,153	1479288	153	1479496	169	1479707	284
1479086	91,161	1479289	17	1479504	150,151,157,281	1479710	285
1479144	193	1479290	17	1479508	121,309	1479711	285
1479152	150,151,155,281	1479297	196	1479518	292	1479712	284
1479153	36	1479305	182	1479534	289	1479715	290
1479154	36,297,	1479306	46,172,299	1479540	292	1479717	14,164
	313,315,319	1479307	173	1479552	13,163	1479732	47
1479155	36,47,226,	1479309	43	1479554	280	1479733	47
	297,313,315,319	1479310	43	1479555	280	1479770	286
1479156	36,47,226	1479311	43,299	1479556	285	1479771	286
1479158	196	1479312	43	1479557	285	1479772	286
1479159	157,281	1479313	43	1479561	264	1479773	286
1479160	157,281	1479314	43	1479562	264	1479784	150,151,157,281
1479161	280	1479315	43	1479563	264	1479794	211
1479181	91,101,162	1479316	43	1479564	264	1479795	211
1479184	12,20,66	1479317	45,176	1479565	264	1479815	150,151,159,254
1479185	12,20,66	1479318	45,176	1479566	264	1479834	44
1479190	19,161,281	1479322	197	1479582	47	1479844	280
1479191	19,161,281	1479326	196	1479583	12,66,265	1479845	280
1479204	194	1479333	280	1479584	12,66,265	1479846	280
1479206	37,47,226	1479334	286	1479585	12,66,265	1479847	280
1479208	37,47,226	1479335	286	1479586	12,66,265	1479848	280
1479222	223	1479337	287	1479591	264	1479849	280
1479223	223	1479338	288	1479592	265	1479853	234
1479224	223	1479348	280	1479593	266	1479860	47,226
1479225	223	1479349	280	1479594	266	1479861	264
1479226	223	1479358	150,151,170,254	1479595	266	1479865	282,283
1479227	223	1479359	196	1479596	266	1479889	236
1479230	18,162,281	1479360	196	1479599	264	1479894	234
1479231	18,162,281	1479372	286	1479600	264	1479946	150,151,159,254
1479232	18,162,281	1479392	289	1479601	265	1479951	234
1479245	53	1479393	289	1479602	265	1479952	290
1479246	53	1479395	289	1479603	265	1479953	290
1479247	53	1479396	289	1479604	265	1479954	290

Part Number Index

1479955290	1499651236	1588175146	1639358220
1479979241	1499656233	1588176142,146	1639359220
149049069	1499659239	1588756142	1639360220
149053074	1499660236	1588880313	1639361220
149053174	1499684235,238	1591019247,248	1639362220
149053274	1499685235,238	1591020250	1639363220
149053374	1499686238	1591022250	1639364220
149902328	1499687238	1591024249	1639365220
1499033	...6,297,299,311,319	1499688238	1591026249	1639366221
1499038	...6,297,299,313,319	1499689238	1591028249	1639367221
149909429	1499690238	1591030249	1639368221
149911029	1499702120,207	1591032250	1639370221
149911129	1499703120,207	1591034250	1639371221
149911229,282	1499704120,207	1591036244	1639372221
149911329	1499705120,207	1591038246	1639373221
149911429	1499706120,207	1591040246	1639374221
149911529	1499707120,207	1591042246	1639375221
149911629	1499708120,207	1591044246	1639376221
149911729	1499709120,207	1591068246	1639377221
149911829	1499710120,207	1591070245	1639378221
149915029	1499711120,207	1591072245	1639379222
149915129	1499720187	1591090244	1639380222
14991718	1499740237	1591093247	1639381222
14993895,295	1499759236	1591094247,248	1639382222
149941330,55	1499794236	1591095247,248	1644027178,299
149941430,55	1499795236	1591096247,248	1644031178,299
14994165,295	1499798236	1591097247,248	1654963270
14994187	1499799236	1591098247,248	1657014123
14994197	1499800236	1591099236,248,297,299,309,311,319	166400087
1499447263	1499810236	1591184251,311	166400187
1499448263	149982528	1591185251	166400287
1499449263	149982628	1591187251	166400387
1499450263	149982728	1591306232	166400487
149947929	149982828	1639335219	166400587
149948028,295	149982928	1639336219	166400687
1499507234,238	149983028	1639337219	166400787
149950831,64	149983128	1639338219	166400887
149951531,64,305	149983228	1639339219	166400987
149951631,64	1499836101,162	1639340219	166401087
149951731,64	1499841211	1639341219	166401187
149951831,64,305	1499842211	1639342219	166401287
149951931,64	1499843211	1639343219,221	166401387
149952031,64	1499844211	1639344219,221	166401487
149960035,49	1499845211	1639345219,221	166401587
149960135,49	1499846211	1639346219	166401687
149960236,49	1499848211	1639347219,221	166401787
149960336,49	1499849211	1639348220,221	166401887
149960437,49	1499850211	1639349220,221	166401987
149960537,49	1499851211	1639350220,221	166402087
149961341,49	1499852211	1639351220,221	166402187
149961449	1499853211	1639352220	166402287
1499639234	149985519,161,281	1639353220	166402387
1499640234	1499862236	1639354220	166402486
1499641238	1499875236	1639355220	166402586
1499647235	1499883236	1639356220	166402686,317
1499648235	158323668	1639357220	166402786,303,313,315,317
1499649235	158360868				

Part Number Index

1664029	86,301	1664086	78	1664178	84	1664409	78
1664030	86	1664087	78	1664179	84	1664410	80
1664031	86	1664088	78	1664180	84	1664411	80
1664032	86	1664089	78	1664181	84	1664412	80
1664033	86	1664090	78	1664182	84	1664413	80
1664034	86	1664091	78	1664183	84	1671000	124
1664035	86	1664092	79	1664184	84	1673956	67
1664036	77	1664093	79	1664185	84	1693951	203
1664037	77	1664094	79	1664186	84	1695790	100
1664038	77	1664095	79	1664187	84	1711160	13,163
1664039	77,309	1664096	79	1664188	84	1711295	13,163
1664040	77	1664097	79	1664189	84	1711342	13,163,295
1664041	77	1664098	79	1664190	82	1711343	13,163
1664042	77	1664099	79	1664191	82	1711510	20
1664043	77	1664100	79	1664192	82	1725062	69
1664044	77	1664101	79	1664193	82	1725150	13,14,67,163,
1664045	77	1664102	79	1664194	82	164,211,295,297	
1664046	77	1664103	79	1664195	82	1754074	142,145
1664047	77	1664105	80	1664196	82	1754136	146
1664048	77	1664106	80	1664197	82	1754137	146
1664049	77	1664107	80	1664198	82	1754138	139
1664050	77	1664108	80	1664199	82	1754285	210
1664051	77	1664109	80	1664200	82	1754286	210
1664052	77	1664110	80	1664201	82	1754287	210
1664053	77	1664111	80	1664202	82	1754288	210
1664054	78	1664112	80	1664203	82	1754371	95,97,
1664055	78	1664113	80	1664204	82	112,205,206	
1664056	78,303,317	1664114	80	1664205	82	1754462	142
1664057	78	1664115	80	1664206	82	1754603	142
1664058	78,301	1664116	80	1664207	82	1754687	105,116,307
1664059	78	1664117	80	1664208	82	1754737	138
1664060	78	1664118	80	1664209	82	1754738	138
1664061	78	1664119	80	1664210	82	1754739	138
1664062	78	1664120	80	1664211	81	1754765	144
1664063	78	1664121	80	1664212	81	1754766	144
1664064	78	1664122	80	1664213	81	1754767	144
1664065	78	1664123	80	1664214	81	1754768	144
1664066	78	1664124	80	1664215	81	1754845	136,137
1664067	78	1664125	80	1664216	81	1754846	138
1664068	78	1664160	83	1664217	81	1754847	138
1664069	78	1664161	83	1664218	81	1777005	236
1664070	78	1664162	83	1664219	81	1777014	236
1664071	78	1664163	83	1664220	81	1777019	236
1664072	78	1664164	83	1664221	81	1777029	63,234
1664073	78	1664165	83	1664222	81	1777040	63
1664074	78	1664166	83	1664230	79	1777041	63,234
1664075	78	1664167	83	1664231	79	1777046	62
1664076	78	1664168	83	1664232	80	1777052	63,305
1664077	78	1664169	83	1664233	79	1777053	63,234
1664078	78	1664170	83	1664234	79	1777054	63
1664079	78	1664171	83	1664236	79	1777117	85
1664080	78	1664172	84	1664237	80	1777122	85
1664081	78	1664173	84	1664238	80	1777123	85
1664082	78	1664174	84	1664405	77	1777124	85
1664083	78	1664175	84	1664406	78	1777125	122
1664084	78	1664176	84	1664407	78	1777126	131
1664085	78	1664177	84	1664408	78	1777139	85

Part Number Index

177715280	1905992208	1906074208	1907128208
1828078206	1905993208	1906075208	1907129208
1828079206	1905994208	1906076208	1907130208
1828283208	1905995208	1906077208	1907131208
1828618266	1905997208	1906078208	1907132208
1828619266	1905998208	1906079208	1907133208
1828740266	1906000208	1906080208	1907134208
1828803105,116	1906001208	1906081208	1907135208
1828833144	1906002208	1906082208	1907136208
1828834144	1906003208	1906083208	1907137208
1828835144	1906004208	1906084208	1907138208
1828836144	1906005208	1906085208	1907139208
1828837144	1906006208	1906086208	1907140208
1828853205	1906007208	1906087208	1907141208
1828854205	1906008208	1906088208	1907142208
1828855205	1906009208	1906089208	1907143208
1828856205	1906010208	1906090208	1907339108
1828861206	1906011208	1906091208	1907357108
1828862206	1906012208	1906092208	1907379108,309,317
1828867112	1906013208	1906093208	1907380108
1828868112	1906014208	1906094208	1907385108
1828869112	1906015208	1906095208	1907394204
1828870208	1906016208	1906096208	1907395204
1828871208	1906017208	1906097208	1907396204
1828872208	1906018208	1906098208	1907398204
1828875208	1906019208	1906099208	1907404105,116
1871696137,138,139	1906020208	1906768108	1907429106
1905079208	1906021208	1906777108	1907434108
1905089208	1906035208	1906856109	1907435108
1905090208	1906036208	1906865109	1907436109
1905091208	1906037208	1906866109,303	1907437109
1905092208	1906038208	1906904208	1907438108
1905093208	1906039208	1906905208	1907440107
1905094208	1906040208	1906906208	1907441107
1905095208	1906042208	1906907208	1907451115
1905096208	1906043208	1906908208	1907489112
1905097208	1906044208	1906909208	1907490112
1905099208	1906045208	1906910208	1907491112
1905100208	1906046208	1906911208	1907492112
1905101208	1906047208	1906912208	1907493112
1905102208	1906048208	1906913208	1907494112
1905103208	1906049208	1906996208	1907495112
1905104208	1906050208	1906999208	1907496112
1905105208	1906051208	1907114208	1907497112
1905106208	1906052208	1907115208	1907557109
1905107208	1906053208	1907116208	1918177266
1905108208	1906054208	1907117208	1918196142
1905109208	1906055208	1907118208	191826697
1905110208	1906056208	1907119208	191826797
1905111208	1906057208	1907120208	191837297
1905112208	1906058208	1907121208	191837397
1905113208	1906059208	1907122208	191837497
1905114208	1906060208	1907123208	191837597
1905115208	1906070208	1907124208	191837697
1905116208	1906071208	1907125208	191837797
1905117208	1906072208	1907126208	191838497
1905118208	1906073208	1907127208	191838597

Part Number Index

1918387	97	1918719	204	1918786	117	1933424	18
1918388	97	1918720	204	1918802	147	1933425	34,40,47,226,233
1918626	95	1918721	204	1918803	147	1933443	235
1918627	95	1918722	204	1918804	147	1933530	217
1918652	136,142	1918723	204	1918805	147	1933531	217
1918667	204	1918724	204	1918806	147	1933532	217
1918668	204	1918725	204	1918807	147	1933533	217
1918669	204	1918726	204	1918808	147	1933534	214
1918670	204	1918727	204	1918809	146	1933535	214
1918671	204	1918728	204	1918810	147	1933536	214
1918672	204	1918729	204	1918811	147	1933537	214
1918673	204	1918730	204	1919505	115	1933538	214
1918674	204	1918731	204	1919547	115	1933539	214
1918675	204	1918732	204	1933056	31,64	1933540	215
1918676	204	1918741	209	1933057	284	1933541	215
1918677	204	1918742	209	1933058	284	1933542	215
1918678	204	1918743	209	1933061	31,64	1933543	215
1918679	204	1918744	209	1933096	19,161	1933544	215
1918680	204	1918745	209	1933098	236	1933545	215
1918681	204	1918746	209	1933151	238	1933546	215
1918682	204	1918747	209	1933152	233,235,238	1933547	215
1918683	204	1918748	209	1933172	170	1933548	215
1918684	204	1918749	209	1933180	236	1933549	216
1918685	204	1918750	209	1933184	236	1933550	216
1918686	204	1918751	209	1933192	19,161	1933551	216
1918687	204	1918752	209	1933193	19,161	1933552	216
1918688	204	1918753	209	1933194	19,161	1933553	216
1918689	204	1918754	209	1933228	236	1933554	217
1918690	204	1918755	209	1933284	101,162	1933555	217
1918691	204	1918756	209	1933285	207	1933556	215
1918692	204	1918758	209	1933286	162	1933557	215
1918693	204	1918759	209	1933307	40,47,226	1933558	215
1918694	204	1918760	209	1933308	40	1933561	217
1918695	204	1918761	209	1933309	40,47,49,226	1933562	217
1918696	204	1918762	209	1933310	40,49	1933563	215
1918697	204	1918763	209	1933319	34,47,226,297	1933564	217
1918698	204	1918764	209	1933320	34	1933565	217
1918699	204	1918765	209	1933321	34,47,49,226	1933566	217
1918700	204	1918766	209	1933322	34,49	1933567	217
1918701	204	1918767	209	1933323	47,226,233	1933568	217
1918702	204	1918768	209	1933324	233	1933569	217
1918703	204	1918769	209	1933325	49,233	1933582	19,161
1918704	204	1918770	209	1933326	49,233	1938008	110
1918705	204	1918771	209	1933327	233	1938056	117
1918706	204	1918772	209	1933328	233	1938996	117
1918707	204	1918773	209	1933329	49,233	1985040	144
1918708	204	1918774	209	1933330	49,233	1985041	144
1918709	204	1918775	209	1933331	47,226,233,295	1985275	110
1918710	204	1918776	209	1933332	233	1FM(3)ØE-AMP-LAB	156
1918711	204	1918777	117,210	1933333	49,233	1FM(3)ØE-AMP-LAB	150,151
1918712	204	1918778	117,210,307	1933334	49,233	1FM(4)ØE-AMP	150,
1918713	204	1918779	117,210	1933352	47,63,226		151,156
1918714	204	1918780	117,210	1933412	40	1FM(4)ØE-AMP-LAB	150,
1918715	204	1918781	117,210	1933420	235		151,156
1918716	204	1918782	117,210	1933421	235	1FM(6)ØE-AMP	150,151,156
1918717	204	1918783	117,210	1933422	207	1FM(6)ØE-AMP-LAB	150,
1918718	204	1918784	117,210	1933423	153		151,156

Part Number Index

1FM-ØE-AMP-LAB 150,
 151,156
 1FM-ØE-AMP-PHONE 150,
 151,156
 1FM-ØØE-AMP 150,151,156
 1FM-ØØE-AMP-LAB 150,
 151,156

2

219153 29
 219172 31,313
 219173 31,313
 219174 31
 219175 31
 219184 29
 219241 29
 219242 29
 219243 29
 219244 29
 219245 29,285
 219246 29,285
 219513 7,297,299,317,319
 219538 7,281,297,299,
 313,315,317,319
 219560 5,281,297,
 299,313,319
 219567 5,297,
 299,311,319
 219596 31,313
 219597 31,313
 219598 31
 219599 31
 219884 28,297,299,
 305,311,313,319
 219885 28
 219886 28
 219887 28
 219888 28
 219889 28,285
 219890 28,285
 219891 28
 224928 70
 228433 136,137,140,143
 229378 72
 229384 73
 229451 73
 229764 73
 229912 23
 229913 23
 230238 73
 230328 72
 231652 12,66,70,71
 231662 71
 231666 12,66,71
 231890 72
 2FM-(12)ØE-AMP-LAB 150,
 151,156

2FM-(6)ØE-AMP-LAB 150,
 151,156
 2FM-D(4)ØE-AMP 150,
 151,156
 2FM-D(6)ØE-AMP 150,
 151,156
 2FM-DØØE-AMP 150,
 151,156

3

354940 70
 3664404 77

4

406042 47,226
 406089 173
 406090 173
 406091 46,172
 406185 150,151,154,254
 406330 37,47,226
 406332 37,47,226
 406350 182
 406351 71,182
 406352 46,172,299
 406359 44
 406360 45,176
 406361 45,176
 406363 44,299
 406365 44
 406367 44
 406369 44
 406370 44
 406372 16,166
 406373 16,166
 406375 16,166
 406376 185
 406388 45,176
 406389 45,176
 406390 37
 406397 182
 406483 29,297,299,305,
 309,313,315,317,319
 406498 225
 406641 55,59
 406771 197,199,313
 406772 197
 406788 198
 406789 198
 406790 198
 406810 193,315
 406817 194,315
 406818 91,194
 406819 91,194
 406820 91,194
 406955 178
 406956 178
 406957 179

406981 37,47,226
 492025 146
 492026 146
 492131 146
 492322 136,140
 492543 136,140
 492622 146
 492623 146
 492674 137,138,139
 492697 136,137
 492703 139
 492782 146
 492783 146
 4664104 79

5

57814 9
 57815 9
 57825 8,297,299,
 309,317,310
 57826 8,297,299,
 313,315,317,319
 58424 146
 58433 146
 58532 146
 58551 146
 58552 146
 58568 71
 501258 136,141
 501381 100
 501473 143
 501818 145
 502129 143
 502134 143
 502222 143
 502259 145
 502306 136,143
 502418 136,142
 502604 91,174
 502631 145
 502656 145
 502748 136,143
 503085 127
 503086 127
 503273 100
 503304 145
 503330 136,140
 503337 145
 503577 99
 503605 145
 503662 91,174
 503681 99
 503705 140
 503706 136,140
 503746 136,141
 503887 136,143
 503890 146

503910 146
 503911 146
 503957 136,140
 503997 150,151,158,254
 503998 150,151,158,254
 503999 150,151,158,254
 504021 100
 504035 136,142
 504064 145
 504290 145
 504629 158
 504641 158
 504643 158
 504662 91,100,160
 552705 23
 553912 23
 553913 23
 554169 12,21,66
 554170 12,66
 554547 23
 554710 12,21,66
 554720 12,21,66
 554739 12,21,66
 554875 23
 554876 23
 554905 23
 555042 12,21,66
 555043 39
 555049 17
 555050 17
 555051 17
 555052 17
 555174 12,21,66
 555175 12,21,66
 555177 12,21,66
 555242 25
 555249 24
 555269 49
 555273 49
 555275 49
 555276 49
 555329 25
 555330 25
 555346 39
 555366 39
 555370 39
 555375 39
 555376 17
 555377 17
 555383 39
 555414 25
 555417 12,21,66
 555426 12,21,66
 555480 39
 555481 39
 555482 39
 555483 39

Part Number Index

555535	177	557415	38	558512	174	569433	57
555601	46,172,175	557429	42	558527	22	569434	57
555611	180	557430	42	558530	12,21,66	569438	57
555614	180	557431	42	558639	59	569439	57,297,299,317
555617	180	557474	91,187	558716	185	569440	57
555621	180	557502	150,151,154,254	558717	186	569444	57
555625	180	557505	150,151,154,254	558718	186	569445	57
555631	181	557548	47,63,226,233	558821	259	569446	57
555642	181	557557	177	558838	57	569477	22
555644	181	557558	177	558839	57	569479	22
555645	181	557601	185	558840	57	569480	22
555650	174,175	557655	187	558841	57	569499	170
555669	180	557685	168	558842	57	569523	30,59
555670	174	557691	150,151,154,254	558843	57	569524	30,59
555672	180	557751	192	558856	42,187	569525	30,59
555725	182	557772	168	558860	42	569526	30,59
556090	46	557775	91,151,168,254	558861	42,187	569527	30,59
556180	39	557776	168	558862	42,187	569528	30,59
556183	39	557827	29	558907	179	569530	12,21,66
556186	39	557857	24	558908	178,299	569532	12,21,66
556189	39	557913	168	558909	178,299	569542	12,21,66
556205	49	558086	150,151,154,254	558912	181	569550	12,21,66
556222	188	558088	150,151,154,254	558914	179	569552	12,21,66
556245	45	558106	150,151,189,309,313	559066	127	569597	54,58
556246	45	558107	150,151,189	559089	127	569599	54,58
556247	45	558176	259	559369	224	569646	151,187
556263	188	558191	150,151,191	559370	224	569648	151,187
556340	174	558198	259	559371	224	569669	30,59
556438	42,50,115	558199	259	559433	127,128,132	569672	30,59
556560	225	558251	170	559496	130,132	569673	30,59
556561	115,225	558257	38	559501	130,132	569685	30,59
556562	225	558258	38	559515	121	569686	30,59
556598	175	558259	38	559517	120	569687	30,59
556599	175	558265	225	559523	121	569851	54,58
556625	17	558266	49	559532	127	569852	54,58
556627	17	558267	49	559542	125,301,303, 313,315,317	569853	58
556641	39	558268	49	559552	126	569854	58
556679	177	558269	49	559557	121	569855	58
556680	177	558301	47,226	559577	121	569856	58
556706	72	558312	225	559558	121,309, 313,315,317	569857	58
556745	225	558329	47,224,226	559560	130	569858	58
556905	39	558331	47,224,226	559561	130	569875	22
556965	50	558334	225	559561	130	569916	150,151,187
557243	181	558357	150,151,190	559596	121,235,317	569917	150,151
557260	179	558400	56	559601	121	569949	69
557272	179	558401	56	559614	125	569983	42,187
557280	179,299	558402	56	559917	187	5492065	110
557284	179	558417	258	564978	22	5492081	110
557315	12,21,66	558420	24	568635	59	5492123	98
557322	91,187	558421	24	568637	59	5492193	110
557350	91,168	558471	189	569049	47,224,226	5492458	99
557361	168	558476	191	569127	150,151,191	5492591	108
557364	168	558488	191	569278	12,21,66	5492642	95
557366	168,254	558489	191	569332	16,166	5492643	95
557396	49	558492	191	569389	54,58	5501380	99
557403	38	558493	191	569431	54,58	5502579	99
557411	38	558510	174,299	569432	57	5502580	99

Part Number Index

5502632	100	6278873	204	6588568	203	6754482	95
5502776	100	6278874	204	6588569	203	6754483	95,303
5502780	100	6278875	204	6588570	203	6754484	95
5503137	100	6278876	204	6588571	203	6754485	95
5503571	99	6278878	204	6588572	106,307	6754882	105,116
5503613	99	6278879	204	6588573	106	6828104	204
5503692	96	6278880	204	6588849	110	6828151	108,307
5503693	96	6278881	204	6588878	203,301	6828233	203
5503948	98	6278882	204	6588879	203	6828234	203
5504000	96	6278883	204	6588880	93,315	6828235	203
5504001	96	6278884	204	6693276	95	6828236	203
5504034	96	6278890	204,301	6693278	95	6828237	203
5504614	100	6278891	204	6693532	110	6828238	203
5504640	91,100,160	6278892	204,301	6693533	110	6828239	204
5504646	98	6278893	204	6693949	203	6828240	204
5504655	98	6278894	204	6745271	209	6828241	204
5504657	98	6278895	204	6754252	202	6828242	204
5504663	91,100,160	6278896	204	6754269	209	6828243	204
5504928	98	6278897	204	6754270	209	6828244	204
5504931	98	6278898	204	6754272	209	6828245	204
5504932	98	6278899	204	6754273	209	6828246	204
5504934	98	6278900	204	6754274	209	6828247	204
5504936	98	6278901	204	6754275	209	6828248	204
5530948	98	6348522	95,98	6754276	209	6828249	204
6		6374018	110	6754277	209	6828250	204
		6374019	110	6754278	209	6828251	204
603227	48,227	6374020	110	6754279	209	6828252	204
604751	48,227	6374208	94	6754280	209	6828253	204
604771	48,227	6374645	107	6754281	209	6828254	204
604772	48,227	6374646	107	6754282	209	6828255	204
608046	192	6374647	107	6754283	209	6828256	204
608440	192	6374906	100	6754284	209	6828257	204
608441	192	6378153	111	6754285	117	6828258	204
641337	12,21,66	6435024	105,116	6754286	117	6828259	204
6278009	95	6435025	105,116	6754287	117	6828260	204
6278028	106	6435027	105,116	6754288	117	6828261	204
6278030	106	6435028	105,116	6754333	117,307	6828262	204
6278031	106	6435029	105,116	6754400	110	6828263	204
6278032	106	6435031	105,116	6754401	110	6828264	204
6278033	106	6435035	105,116	6754402	110	6828265	204
6278079	95	6435039	105,116	6754404	110	6828266	204
6278080	95,309	6435067	117	6754406	204	6828267	204
6278082	95	6435069	117	6754407	204	6828268	204
6278126	106,204	6435070	105,116	6754408	204	6828269	204
6278127	106	6435092	111	6754409	204	6828270	204
6278128	106,313,315	6435094	111	6754410	204	6828271	204
6278199	107	6435096	111	6754411	204	6828272	204
6278207	109	6435180	117	6754412	204	6828273	204
6278298	107	6435181	117	6754413	204	6828274	204
6278303	93	6457240	107	6754420	209	6828275	204
6278357	111	6457567	100	6754421	209	6828276	204
6278358	111	6588077	111	6754422	209	6828277	204
6278414	92	6588078	111	6754423	209	6828278	204
6278415	92	6588079	111	6754424	209	6828279	204
6278418	117	6588080	111	6754425	209	6828280	204
6278810	202,301	6588291	95	6754426	209	6828281	204
6278811	202	6588292	95	6754427	209	6828282	204

Part Number Index

6828283	204
6828284	204
6828285	204
6828286	204
6828317	109,115
6828819	117
6828923	204
6918733	204
6918734	204
6918735	204
6918736	204
6918737	204
6918738	204
6918739	204
6918740	204

7

737893	20
769016	187
769020	187
769021	187
769028	187
790163	12,66,70

8

83935	150,151,154,254
83936	150,151,154,254
853400	12,66,70,71
856727	71

A-Z

B500ACO	175
CM2-U2AMP	150,151,183
CM2-U2AMP-BK	183
CM2-U2AMP-G	183
CM2-U2AMP-GY	183
CM2-U2AMP-WH	183
HUBACO	175
U135806	186
U135820	186
U135830	186
U135840	186

Tyco Electronics Corporation AMP NETCONNECT Global Offices:

North America

Harrisburg, PA, USA
Ph: +1-800-553-0938
Fx: +1-717-986-7406

Europe

Kessel-Lo, Belgium
Ph: +32-16-352-300
Fx: +32-16-352-353

Mid East & Africa

Cergy-Pontoise, France
Ph: +33-1-3420-2122
Fx: +33-1-3420-2268

Latin America

Buenos Aires, Argentina
Ph: +54-11-4733-2200
Fx: +54-11-4733-2282

Asia

Hongkong, China
Ph: +852-2735-1628
Fx: +852-2735-1625

Pacific

Sydney, Australia
Ph: +61-2-9407-2600
Fx: +61-2-9407-2519

www.ampnetconnect.com

Tyco Electronics Corporation AMP NETCONNECT North American Offices:

United States

Harrisburg, PA, USA
Ph: +1-800-553-0938
Fx: +1-717-986-7406
www.ampnetconnect.com

Canada

Markham, Ontario Canada
Ph: 905-474-6222
Fx: 905-474-5519

