

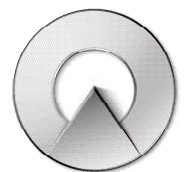

Schindler 3300

Distinctive design. Cost-effective solution.
Advanced technology made easy.



Schindler 3300

4

45

Download from: meppali.net



Smart

Enlightened engineering. Easy to order. Accelerated lead times. Simple to install and a pleasure to design. Its features are thoughtful of the needs of architects, general contractors and passengers alike.

Spacious

More space. Its cab is designed to create more room and comfort. With no need for a machine room or control closet, there's more usable building space. And it fits neatly into the footprint of a hydraulic elevator.

Smooth

A more comfortable ride. Noticeably quiet. Beautifully fluid. Reliably safe. Schindler's exclusive engineering provides smooth, quiet operation for the most comfortable ride experience.

Sophisticated

Understated elegance. Refined without being pretentious. Stylish without being trendy. Energy efficient without being mundane. The Schindler 3300 seamlessly integrates Italian design with precision Swiss engineering.



Download from mepbali.net

Value has a new, intelligent design

The world's most enlightened elevator

The Schindler 3300 has proven itself globally as the smartest choice for low- to mid-rise commercial and residential buildings.

That's because it is engineered like no other everyday elevator. It offers a distinctive range of design and aesthetic options along with an amazingly smooth performance. All in a smaller, easy to fit footprint.

It's setting the new global standard.

More room. More usable space.

As architects and engineers around the world can attest, the Schindler 3300 is designed to minimize the space required for technical equipment, while maximizing the square footage of the cab interior.

Thanks to our new easy-to-install suspension traction media, hoistways designed for a hydraulic elevator can now accommodate a more spacious traction elevator.

Also, because the control is distributed throughout the system, and inspection and test panels are located in the top landing hoistway door jamb, the Schindler 3300 needs no machine room. What's more, it requires minimum overhead, eliminating unsightly structures on your roof. All told, the Schindler 3300 gives you more space and reduces construction costs.

Smooth to the eyes and ears

Schindler cabs are constructed using only high-quality materials. And with standard palettes that are anything but "standard," we can provide exceptional looks, while keeping lead times and costs down. From stainless steel to a distinctive collection of attractive color laminates, your design choices are easier than ever before.

To add to the aura, we are also working to reduce noise. Our suspension traction media enables the Schindler 3300 to glide peacefully through your building. Elevator movements go virtually unnoticed — which will certainly be appreciated by guests in your building.

Sophisticated design for our passengers

With automatic evacuation available, we've elevated our focus on safety. In the event of a power failure, you will be taken safely to the next floor.

Fast facts

Capacity	2,100 – 3,500 lbs., 13 – 21 passengers
Travel height	Max. 98 feet 5 inches
Stops/Openings	12 stops, with up to 16 openings
Door width	36 – 42 inches
Door height	84 inches
Drive	Regenerative drive standard
Speed	100/150 FPM
Control	Selective collective
Interior	Plastic laminate or brushed stainless steel
Compliance	Meets applicable federal, state and local codes. Check with your local sales representative for details.



Download from: meiball.com



Efficient mobility

The features and components of the Schindler 3300 are designed to provide efficient mobility. From the drives, to the stylish, stainless steel fixtures, you'll find the latest technological advances.

Drive

- Regenerative drive comes standard
- Gearless machine designed to save energy and avoid power loss
- Stable start reduces electric costs
- Frequency converter with standby power mode allows elevator to return safely to nearest floor in the event of a building power outage
- Compact, lightweight and durable design.

Control

- Controls automatically switch car lights to standby mode to save energy
- Car panel and floor indicators all operate with low power, LED lights
- Multi-bus control architecture reduces cabling, material and waste
- Smart controls provide more efficient passenger transportation.

Cab and hoistway

- Ceiling lighting comes standard with classic LED round spot downlights
- Central guiding system reduces friction and overall energy consumption
- Door drive with standby mode uses less electricity
- Overall design provides more usable space for enhanced passenger comfort.



Advanced technology

Drive system

The Schindler 3300 requires a small hoist machine and inverter. This saves more space compared to previous drive systems; it is installed directly in the overhead and does not require a separate machine room. The system stops the car with precision. Cab and landing floor line up very accurately to ensure that passengers get in and out safely. There is minimal noise due to the material of the suspension traction media (STM).

Suspension Traction Media (STM)

The STM consists of thin metal cables sheathed in a non-circular EPDM (Ethylene Propylene Diene Monomer) jacket. They replace conventional steel cables, weigh less, require less space and run quieter. Thanks to the STM, there is room for the machine and drive directly in the elevator hoistway, allowing hydraulic-sized shafts to be utilized.

Inspection and test panel

In the Schindler 3300, the inspection and test panel is built directly into a standard door frame at the top landing. This highly functional solution is a vital achievement. It simplifies elevator installation, provides practical handling and saves space. The Schindler 3300 does not require a space-consuming machine room or control closet. However, some jurisdictions still require such space. In those areas please contact your local Schindler sales representative for a room or closet solution.

Doors

Doors are equipped with a frequency-controlled drive for fast and reliable operations. Two-speed side-opening doors opening to the left or right, as well as single-speed center-opening doors are available.

Cab

Technology does not take much space in the Schindler 3300. This is an obvious benefit that allows hydraulic elevator-sized shafts to be utilized while providing a larger cab interior. This is a striking advantage.

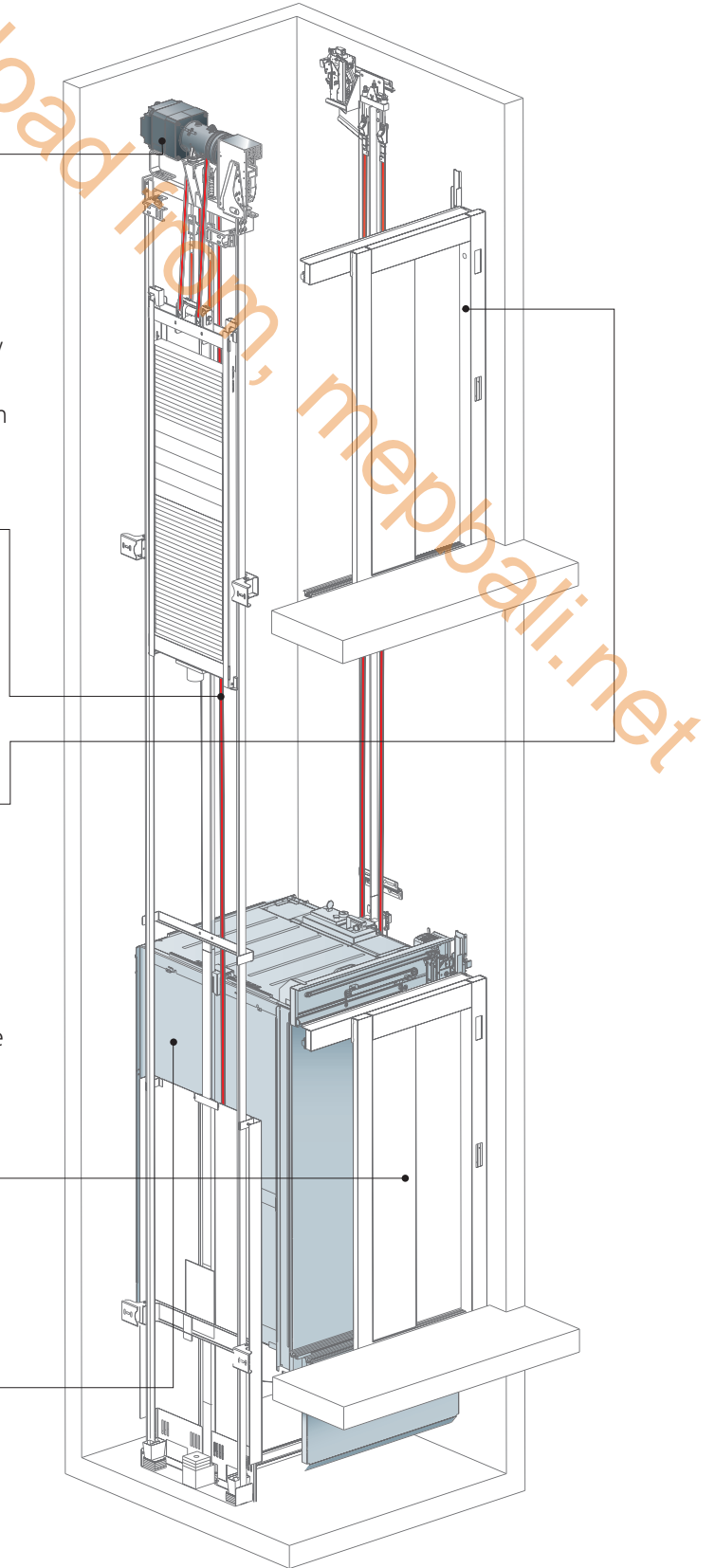

Previously: steel cables

Steel cables are relatively inelastic. They need a traction sheave diameter of at least 12 inches with the cable diameters required for elevators. The complete conventional motor, including drive gears, must be large enough to match. A system that requires space.

New: Suspension Traction Media (STM)

Suspension traction media are flexible. They use a much smaller traction pulley diameter than steel cables. 4.25 inches is enough, requiring a much smaller motor. A design that saves space.

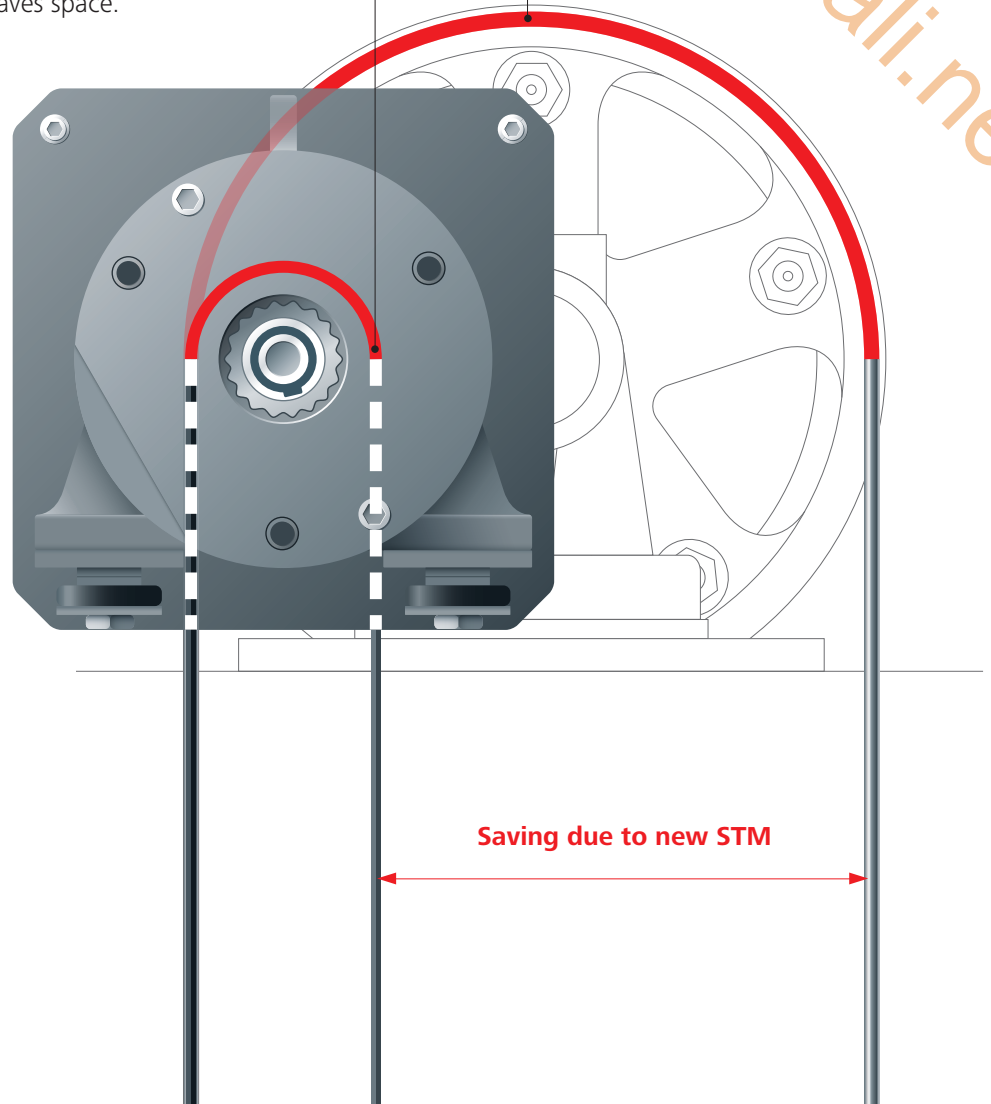

We put a premium on design, without charging a premium.

All around the world, architects and designers are discovering a new creative outlet. Conceptualized by an Italian designer, the Schindler 3300's sleek cab design is impressive yet understated. Simple, yet refined, with design palettes to suit any style or building décor.

- Cab walls are available in stainless steel or a choice of plastic laminates.
- The unique ceiling design comes standard in brushed stainless steel.
- Ceiling lighting comes standard with classic LED round spot downlights.
- Elegant handrail options include a round design in brushed stainless steel and a rectangular design in brushed aluminum. Both handrail designs are available in cut and return ends.
- Landing doors are available in brushed stainless steel, various colors of durable powder coat or primer. Doors are available in center-opening or side-opening configurations, with left-hand or right-hand openings.
- Hall fixtures are composed of stainless steel and tempered safety glass panels, back-printed in white, to give the Schindler 3300 a contemporary, modern look.

Note: The car specifications, options and colors in this brochure are representative only and are subject to change. Sample shown may vary from the original in color and material.

*Quantity of LED round spot downlights depends on the elevator size/ configuration.



Laminate – Mesa Mercury Glass



Corners Skirting – Anodized aluminum, grey

Download from mepbali.net



Landing doors — available in powder coat colors or stainless steel



Hall fixtures



Handrail — round, return end



Ceiling lighting - standard LED round spot downlights*



Handrail — rectangular, cut end

If you can envision it, you can create it

The Schindler 3300 gives you a selection of colorful laminate finishes, as well as a sleek brushed stainless steel cab. Create a look and feel that is truly one of a kind.



Brushed stainless steel #4



Corners
Skirting
**Anodized
aluminum, grey**

Distinctive brushed stainless steel cab is an optional upgrade



Mesa Mercury Glass

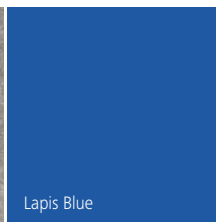

Lapis Blue



Antique White

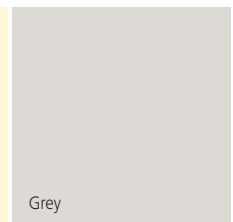

Grey

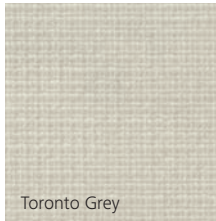

Toronto Grey



Milwaukee Pewter

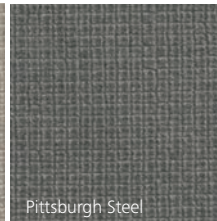

Pittsburgh Steel

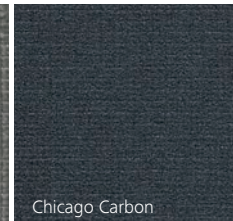

Chicago Carbon

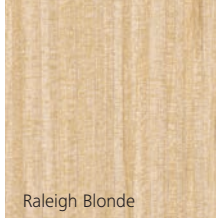

Raleigh Blonde

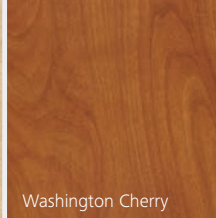

Washington Cherry

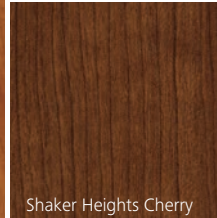

Shaker Heights Cherry

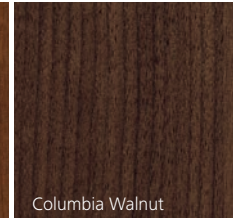

Columbia Walnut

Striking details

Entrances and cab details are available in durable powder-coated and stainless steel finishes. Mix or match entrances and landing doors finishes as desired and make the statement that suits your design.

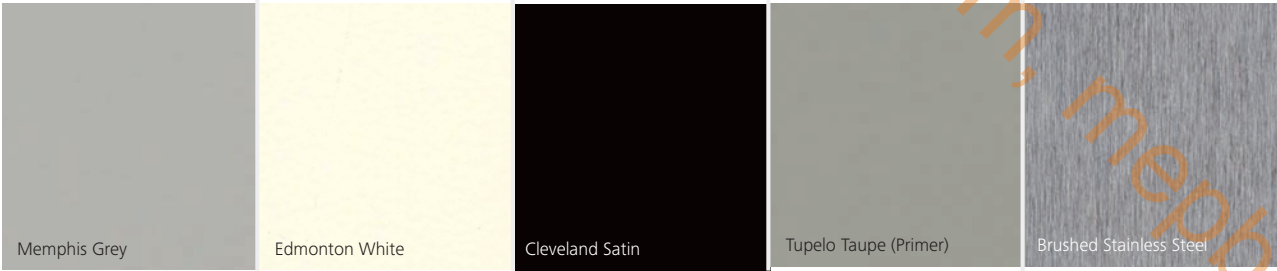

The perfect fusion of people-centered design and technology

The features and components of the Schindler 3300 are smartly designed to enhance the rider experience, improve safety and minimize downtime. From the low-energy multiprocessor controls to the stylish, tempered safety glass operating panels, you'll find the latest technological advances.

Control

The control system is based on low-energy multiprocessor technology. The compact main inspection and test panel of the decentralized system is integrated in the door frame.

Control functions

- Miconic® NX microprocessor
- On-board diagnostics, self testing
- Light curtain
- Overload detection
- Two-way, hands-free emergency communication
- Firefighter's Service operation
- Independent service
- Automatic car light
- Available automatic evacuation to nearest floor.

Fixtures

The combination of back-printed white glass and stainless steel give the elevator a contemporary, modern look while meeting all applicable codes.

In addition to the standard half-height fixtures there is an optional fixture line offering a full length, flush mounted car operating panel. This optional fixture line is also available in a vandal resistant design.

Please refer to Schindler's Low Rise Traction Elevator Fixtures brochures for more information and fixture options.



Standard car operating panel:
half-height, surface-mounted



Vandal-resistant
car operating panel:
full-length, flush-mounted

State-of-the-art planning, installation and support



Planning

The Schindler 3300 requires no machine room. For you, this means less planning. Only one space, the elevator shaft, has to be designed. Standardized plans simplify the process, making it fast and efficient.

Order

The design of the Schindler 3300 is sophisticated, yet simple. The key factors are quickly established. Since there are no complicated specifications, it is easy to place an order. You will quickly and effortlessly find the product that fits your needs.



Delivery

We deliver the Schindler 3300 complete and all at once, just in time for when the building is ready for the elevator installation.

Installation

The elevator is quickly installed. No cranes or scaffoldings are required. The system is ready in about two weeks. A well-thought-out process.

Schindler 3300 MRL Traction Elevator

General Purpose

Standard Speeds: 100, 150 fpm (0.5, 0.75 m/s) 16 Openings max
 Travel: Up to 98'-5" (30.0 m)

Hatch plans

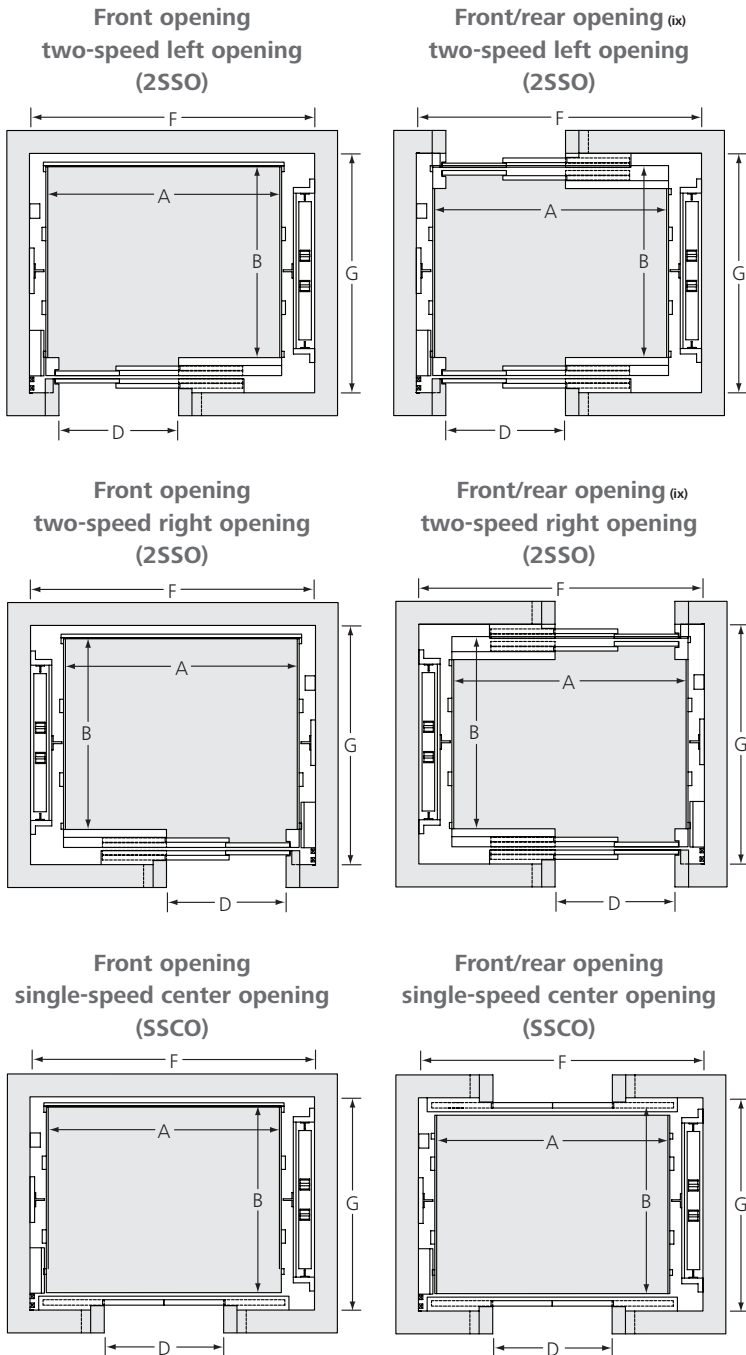

Hoistways

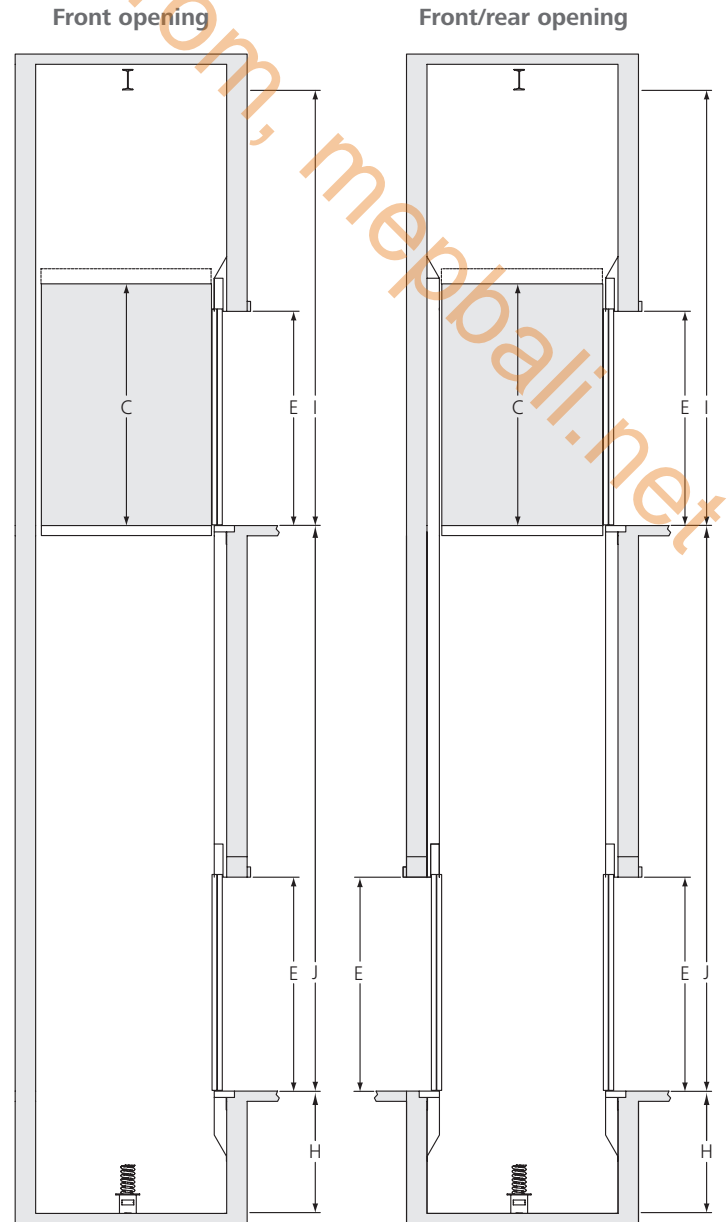

Machine room-less traction elevator with frequency-controlled drive

Capacity 2100 – 3500 lbs, 13 – 21 passengers

Capacity lbs (kg)	Passengers max.	Speed fpm (m/s)	Number of stops max.	Available en- trances max.	Car (Inside)			Door			Shaft (Inside)				Travel height max. J (vi) ft (m) / FPM (m/s)	
					A in (mm)	B in (mm)	C in (mm)	Door type	D in (mm)	E in (mm)	Entrance type (x)	F (iii)(vii) ft (mm)	G ft (mm)	H (viii) ft (mm)		I (iv) ft (mm)
2100 (950)	13	100/150 (.5/.75)	12	16	5'-9 5/16" (1761)	4'-4 7/8" (1343)	7'-9" (2366)	2SSO	3'-0" (915)	7' (2134)	Front or Front/ rear	7'-6" (2286) 7'-6" (2286)	5'-9" (1755) 6'-5 5/8" (1972)	5'-0" (1524) 5'-0" (1524)	12'-7" (3835) 12'-7" (3835)	98'-5" (30.0) / 150 (.75) 59' (18)/100 (.5)
2500 (1135)	15	100/150 (.5/.75)	12	16	6'-9 5/16" (2066)	4'-4 7/8" (1343)	7'-9" (2366)	2SSO/ SSCO	3'-6" (1067)	7' (2134)	Front or Front/ rear	8'-6" (2591) 8'-6" (2591)	5'-9" (1755) 6'-5 5/8" (1972)	5'-0" (1524) 5'-0" (1524)	12'-7" (3835) 12'-7" (3835)	
3000 (1360)	18	100/150 (.5/.75)	12	16	6'-9 5/16" (2066)	4'-10 7/8" (1495)	7'-9" (2366)	2SSO/ SSCO	3'-6" (1067)	7' (2134)	Front or Front/ rear	8'-6" (2591) 8'-6" (2591)	6'-3" (1905) 6'-11 5/8" (2124)	5'-0" (1524) 5'-0" (1524)	12'-7" (3835) 12'-7" (3835)	
3500 (1590)	21	100/150 (.5/.75)	12	16	6'-9 5/16" (2066)	5'-6 7/8" (1699)	7'-9" (2366)	2SSO/ SSCO	3'-6" (1067)	7' (2134)	Front or Front/ rear	8'-6" (2591) 8'-6" (2591)	6'-11 1/16" (2110) 7'-7 5/8" (2328)	5'-0" (1524) 5'-0" (1524)	12'-7" (3835) 12'-7" (3835)	

A Inside cab width
B Inside cab depth
C Inside cab height to underside of roof. [Inside cab height to finished ceiling is 7'-5 3/16" (2265).]
D Door Width
E Door Height

F Shaft width
G Shaft depth
H Pit depth
I Overhead

- Notes:**
 All dimensions are for information only and cannot be used for construction purposes without Schindler confirmation.
 (i) 2SSO doors available with right or left opening.
 (ii) Duplex operation available.
 (iii) Seismic areas require 2" more hoistway width. Please contact your Schindler Sales Representative for details and options.
 (iv) Clear overhead is defined from the lowest point below any obstruction such as: hoist beam(s), building beams, or roof structure to floor of top landing. For jurisdictions following ASME A17.1 code prior to 2009, please add 1 additional inch of overhead at 150 FPM.
 (v) Where permitted by code, no control closet is required. A 3-phase disconnect must be located in both the hoistway overhead and a location in the building outside of the hoistway. 110v disconnect should be located outside of hoistway. Disconnects are not required to be an elevator-dedicated space. Please confirm with local requirements.
 (vi) Travel height max. varies depending on speed (FPM) and capacity (lbs).
 (vii) Schindler 3300 also fits into a smaller hydraulic footprint with 2" less hoistway width. Please contact your Schindler Sales Representative for additional information.
 (viii) Please contact your Schindler Sales Representative for options less than 5'-0".
 (ix) Please contact your Schindler Sales Representative for additional hatch options such as diagonal entrances.
 (x) Shaft dimensions depend on if there are front or front/rear entrances.

Schindler 3300 MRL Traction Elevator

General Purpose

Standard Speeds: 100, 150 fpm (0.5, 0.75 m/s) 16 Openings max
Travel: Up to 98'-5" (30.0 m)

General requirements

Requirements for installation vary by type of equipment selected. These general requirements assist you in preparing your building for the installation of Schindler elevators. All designs, clearances, construction, workmanship and materials, unless specifically excepted, shall be in accordance with the requirements of the latest published ASME A17.1 Code for electric traction elevators plus applicable building code and local codes. State or local requirements must be used if more stringent.

Items to be provided — A complete installation includes the following items not included in the elevator contract:

1. Clear, plumb hoistway, with variations on a minimum dimension hoistway not to exceed -0" and +1" (25.4 mm) per side at any point. Tolerance may increase to variations not to exceed -1" (-25.4 mm) and +1" (25.4 mm) per side at any point when an additional 2" (50.8 mm) is provided on the hoistway width dimension.
2. Two-hour fire resistance of hoistway walls or rating to meet applicable local codes. 75° bevel guards on all projections, recesses or setbacks over 4" (102 mm) except on side used for loading or unloading. The overhead machinery space temperature at top of hoistway to be maintained between 41° F (5° C) and 104° F (40° C) and < 95% relative humidity, non-condensing.
3. Supports for rail brackets at pit, each floor and one or two locations above top floor in the overhead (application dependent). Divider beams between hoistways at each floor level and one or two locations above top floor in the overhead for guide rail bracket supports. Locate per layout. For masonry block hoistway construction, Schindler will provide rail bracket inserts for installation by others, located per the Schindler final layout drawings. Where inserts are not used, hollow masonry blocks are not acceptable for bracket fastening. Provide 125 mm (5") concrete belt around hoistway or other acceptable support at each floor, in overhead, and intermediate levels (if required). For max. rail bracket vertical spacing, contact your local sales representative.
4. Supply hoist/safety beam for elevator construction and service work. Beam to run across the width of the elevator shaft. Locate per layout. Hoist beam to be left in place after elevator installation.
5. A temporary work platform is required for installation. It is to be constructed at the top floor of each elevator. It must comply with applicable governing codes and regulations. The platform shall be securely fastened to the building structure. Erection, maintenance, and removal are by others. (Reference Schindler drawing TD440.)
6. Lighting, light switch and duplex receptacle (GFCI) for each elevator, in the center of hoistway pit and in the elevator overhead/machinery space, as indicated by Schindler. The pit light switch located adjacent to access door.
7. Recesses, supports, and patching, as required, to accommodate hall button boxes, signal fixtures, etc. (if required).
8. All barricades outside elevator hoistways or between elevators inside hoistways.
9. Dry pit reinforced to sustain normal vertical forces from rails and buffers.
10. Drains & sumps in elevator pits, where provided, shall comply with the plumbing code, and shall be provided with a positive means to prevent water, gases and odors from entering the hoistway. The cover must be secured and level with the pit floor and located to clear elevator equipment. (Cannot be connected directly to storm drain or sewer.)
11. Pit ladders shall be provided where required.

Inspection and test panel

12. A switch placed adjacent to the jamb-mounted inspection and test panel enclosure shall control lighting in front of the panel. Minimum lighting to be 200 lux (19 fc).
13. A lockable, 13 1/2" x 15 1/2" x 3 1/2" (minimum), metal cabinet with group-1 key to house required electrical schematics and maintenance history documents, shall be wall mounted, adjacent to the disconnect switch, by others, at the top landing. The supplier, location, and mounting of the cabinet shall be coordinated with Schindler.
14. Provide, preferably on the same floor as the elevator inspection and test panel, a lockable panel with a fused disconnect switch or circuit breaker suitable for 3-phase power for the elevator control, and a fused disconnect switch or circuit breaker for car lighting for each elevator in a separate lockable panel adjacent to the 3-phase panel or within the 3 phase panel. The panel(s) must be accessible to qualified personnel only (NEC NFPA req. 620.51[C]) with a Group 2 key (ASME A17.1 req. 8.1.3). Alternative locations for the panel(s) can be considered, provided they are located in accessible areas without obstructions to qualified personnel in compliance with NEC NFPA req. 620.51(C). Locate and mark the panels and disconnects with appropriate signage, (NEC NFPA 70 req. 620-22 and 620-51, or CSA C22.1-02 sections 38-022 and 38-053). The disconnects or circuit breakers may also be located without panels in a Group 2 key-secured room identified and dedicated to elevator apparatus only, and in all cases must be capable of being locked in the open position with a lock that cannot be removed from the devices or panel(s). FOR DRIVE IN HOISTWAY CONFIGURATION ONLY: Electrical contractor to supply an additional lockable auxiliary non-fused disconnect in the hoistway at the location of the drive (motor controller), along with wiring from the main disconnect to the auxiliary disconnect (see also NEC NFPA 70 - 2008 req. 620.51[C](1)). This disconnect must also be lockable in the open position with a secured lock that cannot be removed from the device.

15. For ALL power circuits:

- a. If a sprinkler head is located in the hoistway or other disconnect location, any disconnect served by that sprinkler head must be NEMA 3 compliant. Sprinklers shall be located at the top and bottom of the hoistway per NFPA 13-2010 requirement 8.15.5.6 (see also 8.15.5.3) and A.8.15.5.3).
- b. In U.S. jurisdictions ONLY, when a sprinkler head is located in the hoistway, the building shall provide shunt trip activation of a) JH, the main disconnect or b) the feed to the main disconnect, triggered by contacts of the fire recall initiating devices (as defined by NFPA). These devices, located in the hoistway or other disconnect location, shall provide independent disconnection of electrical power to both main and auxiliary power circuits prior to sprinkler activation (ASME A17.1-2007/CSA B44-07 rule 2.8.3.3. and/or local code).

Control spaces (When specified in lieu of an Inspection and Test Panel, a partial or full body entry space/room shall be provided.)

16. Enclosed and protected control space at top landing adjacent to the hoistway wall closest to the elevator hoist machine. Two-hour fire rating of control space walls or rating to meet applicable local codes.
17. Provide fire-rated, self-closing, self-locking door. Door must be capable of opening 180 degrees for access to control space.
18. 42" (1067 mm) minimum clear space is required in hallway in front of control space door and top hoistway entrance for service barriers. Additional hallway width may be required, subject to local building, fire and ADA codes.
19. The temperature in front of the control space must be maintained between 32° F (0° C) and 104° F (40° C) and less than 95% relative humidity, non-condensing, for proper operation of equipment.
20. Disconnects for each elevator must be provided per National Electrical Code (NFPA No. 70) and located inside the elevator control space.

Other wiring

21. Suitable copper feeder, ground and branch wiring circuits for signal system and power operated door. Feeder and branch wiring circuits for car light and fan.
22. Telephone outlet provided at the inspection and test panel or in control closet (where applicable).
23. All conduit and wire runs remote from either the control space or hoistways (if required).
24. Heat, smoke or products of combustion-sensing devices connected to elevator control space terminals when such devices are required. Sprinklers shall be located at the top and bottom of the hoistway per NFPA 13-2010 requirement 8.15.5.6 (see also 8.15.5.3 and A.8.15.5.3). Shunt trip circuit breaker shall also be installed when sprinklers are present in the hoist way.

Emergency provisions

25. Elevator Firefighter's and other emergency services, depending on height of the building or number of landings, per ASME A17.1 Rule 2.27.3 and local codes.
26. Elevator Firefighter's and other emergency services' wiring and interconnections to automatic sprinkler systems or heat and smoke-sensing devices furnished by others.
27. When emergency/standby power operation of elevators is required, the Electrical Contractor should coordinate with Schindler for operation requirements.
28. Provisions for earthquake protection, dictated by building code, are required in various sections of the country.

Entrances

29. Hoistway walls must have a fire rating per ASME A17.1 Rule 2.1.1.1.
30. Furnishing, installing and maintaining the required fire rating of elevator hoistway walls, including the control spaces and also the penetration of fire wall by elevator fixture boxes (if applicable), is not the responsibility of the elevator contractor.
31. The interface of the elevator wall with the hoistway entrance assembly shall be in strict compliance with the elevator contractor's requirements.
32. Entrance wall and finished floor are not to be constructed until after door frames and sills are in place.
 - a. Where front walls are of reinforced concrete, the concrete openings must be minimum 16" (406 mm) wider [8" (203 mm) on each side] and 8" (203 mm) higher than the clear opening.
 - b. Where drywall or sheet rock construction is used for front walls, it shall be of sufficient strength to maintain the doors in true lateral alignment. Drywall contractor to coordinate with the elevator contractor.
Note: A support member must be provided for floor heights greater than 15'-0" (4572 mm) to support entrance header struts.
 - c. Door frames are to be anchored to walls and properly grouted in place to maintain legal fire rating (masonry construction).
33. Filling and grouting around entrance by others.
34. Where openings occur, all walls and sill supports must be plumb.

Seamless connectivity

Made for today. Ready for the future.

With Schindler Ahead, we turn data into results for customers and passengers.

Schindler Ahead is a cloud platform. Using wireless connectivity, this closed-loop digital platform allows your connected equipment to become part of the Building Internet of Things (IoT). Secure, automated data collection and real-time analytics provide insights that allow for predictive maintenance, equipment visibility, maximized uptime and more accurate capital planning. Building owners, facilities managers and passengers can have the relevant information they need, when they need it.

To learn more about Schindler Ahead, visit schindler.com/ahead-us.

Key benefits of Schindler Ahead



- High reliability and uptime improves overall building performance
 - Insights about component lifetime allow for better mid-term planning of repairs and modernizations
 - Complete digital documentation of equipment portfolio
 - 24/7 digital emergency service
 - Increased building value by connecting to Internet of Things
 - Cost-saving solutions with service guarantees and removal of phone line
- High reliability and uptime with fast reaction times, thanks to predictive maintenance
 - Real-time information on equipment status and performance
 - Full transparency on status of maintenance activities, due to push notifications via app, text, or email
- Reduced wait times and increased reliability lead to potential improvements in the passenger experience
 - Regular status updates about equipment and maintenance work via the app, text, or email
 - Increased convenience thanks to interactive and personalized information



Schindler – We Elevate

For more information, including the location of the Schindler office nearest you, please visit:

U.S. Headquarters. Morristown, New Jersey
Tel. 973.397.6500
www.schindler.com

Canada Headquarters. Toronto, Ontario
Tel. 416.332.8280

We Elevate



Schindler has received renewal to ISO 9001 and ISO 14001 certificates.